

No.	Date	Description

NOTE:
 Bid documents should not be separated or issued as partial sets to subcontractors. Bidders are responsible for all portions of the documents that pertain to work covered by sub-bids. Bidder assumes full responsibility for error or misinterpretations resulting from partial sets of Bidding Documents by itself or any sub-bidder.

Conflicting information or errors found in the construction documents should be brought to the attention of the architect immediately. In the event of a conflict in drawings, bidder should not assume the least expensive option will meet the project requirements.



MAVERIK INC. STORE
 LINCOLN AVE. AND DRANSFELDT RD.
 PARKER, CO

EDCI ENGINEERS
 1331 17TH STREET • SUITE 605
 DENVER, COLORADO 80202
 PHONE: (720) 439-4700
 WEBSITE: www.edci-engineers.com
 CIVIL / STRUCTURAL
 © Copyright 2021 EDCI Engineers Inc. All Rights Reserved.

SITE PLAN

KEYED NOTES:

- 1 NEW LIGHT POLE AND BASE PER MAVERIK STANDARD DETAIL SF-6/SHEET 30
- 2 NEW REBOUNDING BOLLARDS IN FRONT OF EACH PARKING SPACE ALONG THE FACE OF BUILDING PER MAVERIK STANDARD DETAIL SF-4/SHEET 30
- 3 NEW HOOP BOLLARDS PER MAVERIK STANDARD DETAIL SF-2/SHEET 30
- 4 NEW TRASH ENCLOSURE PER DETAILS 1-3/SHEET 27
- 5 NEW HI-ROLLER BIKE RACK PER MAVERIK STANDARD DETAIL SF-8/SHEET 31
- 6 NEW CATCH CURB AND GUTTER PER MAVERIK STANDARD DETAIL C-6/SHEET 29
- 7 NEW SPILL CURB AND GUTTER PER MAVERIK STANDARD DETAIL C-7/SHEET 29
- 8 NEW RUNOUT PAD AND MOUNTABLE CURB PER MAVERIK STANDARD DETAIL C-8/SHEET 29
- 9 NEW FUEL DISPENSER BASE PER MAVERIK STANDARD DETAIL SF-7/SHEET 29
- 10 NEW XACTAIR STATION FOUNDATION PER MAVERIK STANDARD DETAIL SF-9/SHEET 30
- 11 NEW ADA PARKING PER MAVERIK STANDARD DETAIL SF-11/SHEET 31
- 12 PAINTED ADA PARKING SYMBOL PER MAVERIK STANDARD DETAIL SF-12/SHEET 31
- 13 NEW UNDERGROUND STORAGE TANKS
- 14 NEW FUEL CANOPY AND FUEL DISPENSERS - STACKED FORECOURT PER MAVERIK STANDARD DETAIL ST-6/SHEET 32
- 15 NEW TRUNCATED DOMES
- 16 ADA ADJUSTABLE SIGNAGE SLEEVE IN BOLLARD
- 17 ADA FUEL DISPENSER WITH SIGN
- 18 NEW CONCRETE PAD FOR ELECTRICAL TRANSFORMER
- 19 5 FOOT CURB TRANSITION FROM MOUNTABLE TO VERTICAL CURB
- 20 ADA PATH TO ADA ACCESSIBLE FUEL PUMP (REFERENCE ONLY NO STRIPPING)
- 21 NEW 4' WIDE CROSSSPAN PER _____

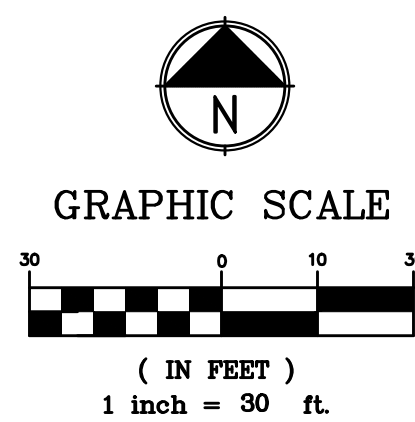

THE TOWN OF PARKER REVIEW CONSTITUTES GENERAL COMPLIANCE WITH THE TOWN'S STANDARDS AND APPROVED VARIANCES, SUBJECT TO THESE PLANS BEING STAMPED, SIGNED, AND DATED BY THE PROFESSIONAL ENGINEER OF RECORD. REVIEW BY THE TOWN DOES NOT CONSTITUTE APPROVAL OF THE PLAN DESIGN OR ACCURACY AND CORRECTNESS OF ENGINEERING CALCULATIONS. ERRORS IN THE DESIGN OR CALCULATIONS REMAIN THE RESPONSIBILITY OF THE REGISTERED PROFESSIONAL ENGINEER WHOSE STAMP AND SIGNATURE ARE AFFIXED TO THIS DOCUMENT.

THIS REVIEW DOES NOT CONSTITUTE APPROVAL OF ANY PRIVATE ON-SITE IMPROVEMENTS WHICH MAY BE SHOWN. CONSTRUCTION CANNOT COMMENCE UNTIL ALL REQUIRED DRAINAGE/TRAFFIC REPORT(S), FINAL DEVELOPMENT PLAN(S), SPECIAL REVIEW(S), GRADING PERMIT, AND/OR OTHER PERMITS ARE COMPLETE, APPROVED AND ON FILE WITH THE TOWN OF PARKER.

TOWN OF PARKER, DIRECTOR OF ENGINEERING _____ DATE _____

CONTRACTOR NOTE:

ALL EXISTING UTILITIES SHOWN ON PLANS ARE TO BE VERIFIED HORIZONTALLY AND VERTICALLY PRIOR TO ANY CONSTRUCTION. ALL EXISTING FEATURES INCLUDING BURIED UTILITIES ARE SHOWN AS INDICATED ON RECORD MAPS AND SURVEYS FURNISHED BY OTHERS. WE ASSUME NO LIABILITY FOR THE ACCURACY OF THOSE RECORDS AND SURVEYS. CONTACT THE UTILITY OWNER/AGENCY FOR THE FINAL LOCATION OF EXISTING UTILITIES IN AREAS CRITICAL TO CONSTRUCTION.



AR DP XX-XXXX

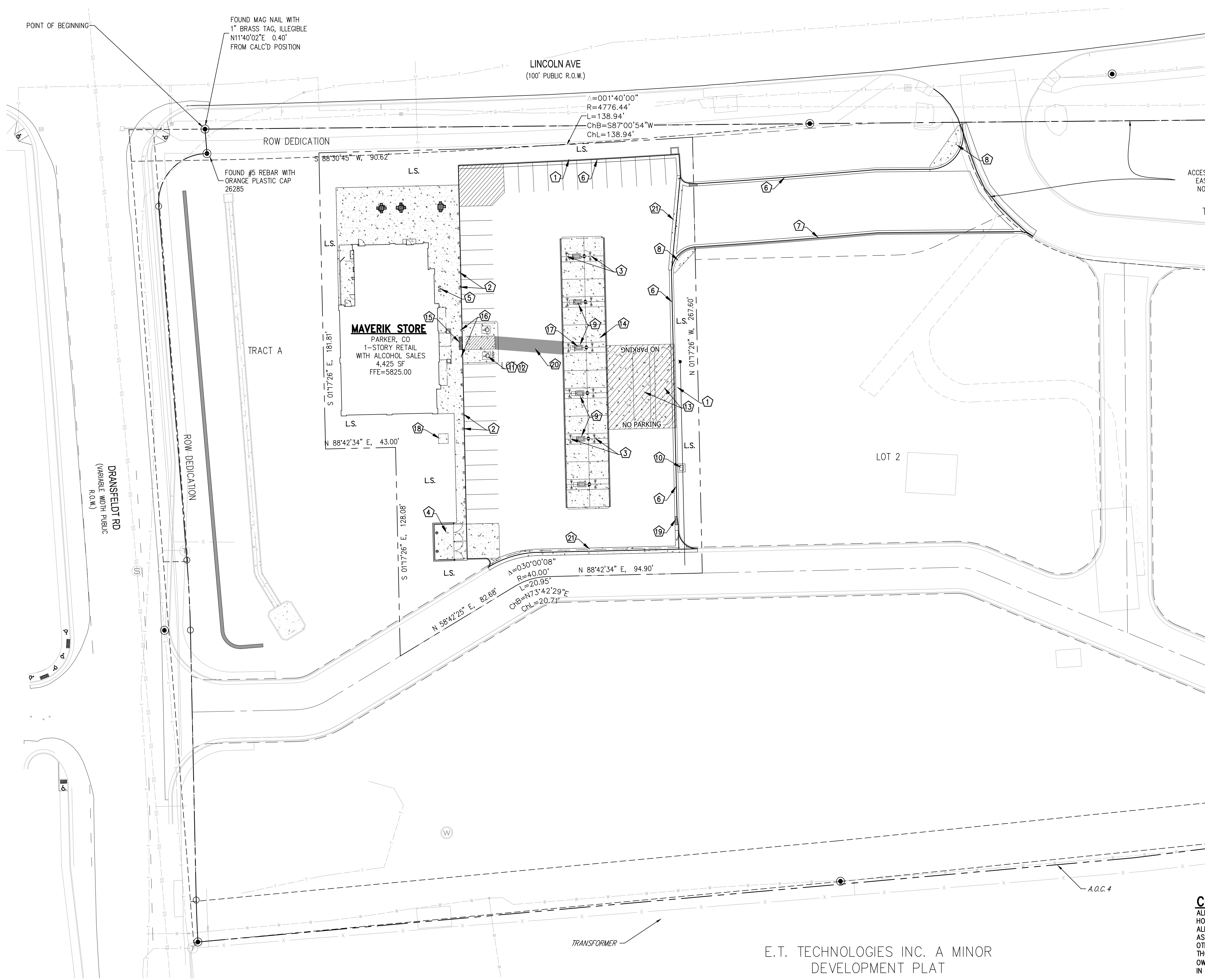

E.T. TECHNOLOGIES INC. A MINOR DEVELOPMENT PLAT

MAVERIK INC. STORE

SITUATED IN THE NORTHWEST ¼ OF SECTION 15,
TOWNSHIP 6 SOUTH, RANGE 66 WEST OF THE 6TH P.M.
TOWN OF PARKER, COUNTY OF DOUGLAS, STATE OF COLORADO

CONSTRUCTION DOCUMENTS

PROJECT NUMBER

21-122-0001

ISSUE DATE:

June 18, 2021

REVISIONS:

No.	Date	Description

NOTE:
Bid documents should not be separated or issued as partial sets to subcontractors. Bidders are responsible for all portions of the documents that pertain to work covered by sub-bids. Bidder assumes full responsibility for error or misinterpretations resulting from partial sets of Bidding Documents by itself or any sub-bidder.

Conflicting information or errors found in the construction documents should be brought to the attention of the architect immediately. In the event of a conflict in the drawings, bidder should not assume the least expensive option will meet the project requirements.

GENERAL PLANTING NOTES

1. THE CONTRACTOR SHALL BE FAMILIAR WITH THE SITE CONDITIONS PRIOR TO CONSTRUCTION. THE CONTRACTOR IS RESPONSIBLE FOR LOCATING ALL UNDERGROUND UTILITIES AND SHALL AVOID DAMAGE TO ALL UTILITIES DURING CONSTRUCTION. SHOULD THE CONTRACTOR CAUSE DAMAGE TO ANY UTILITIES, CONTRACTOR SHALL MAKE NECESSARY REPAIRS AS QUICKLY AS PRACTICABLE, AT OWN EXPENSE.
2. THE CONTRACTOR IS RESPONSIBLE FOR MAINTAINING, IN FULL, ALL PLANTING AREAS (INCLUDING WATERING, SPRAYING, MULCHING, MOWING, FERTILIZING, ETC.) UNTIL THE JOB IS ACCEPTED, IN FULL, BY THE LANDSCAPE ARCHITECT AND OWNER.
3. ALL PLANTS MUST BE HEALTHY, VIGOROUS MATERIAL, FREE OF PESTS AND DISEASE. ALL PLANTS SHALL BE ANA #1 OR BETTER (ACCORDING TO "AMERICAN STANDARDS FOR NURSERY STOCK") AND ARE SUBJECT TO THE APPROVAL OF THE LANDSCAPE ARCHITECT AND OWNER BEFORE, DURING, AND AFTER INSTALLATION.
4. CONTRACTOR TO STAKE BED LINES IN FIELD FOR OWNER'S REPRESENTATIVE APPROVAL PRIOR TO COMMENCEMENT OF PLANTING.
5. ALL TREES MUST BE STRAIGHT TRUNKED, FULL HEADED, AND MEET ALL REQUIREMENTS SPECIFIED.
6. ALL TREES MUST BE GUYED OR STAKED AS SHOWN IN THE DETAILS.
7. CONTRACTOR SHALL ASSURE DRAINAGE AND PERCOLATION OF ALL PLANTING PITS PRIOR TO INSTALLATION OF PLANT MATERIAL. CONTRACTOR SHALL FILL ALL TREE PITS WITH WATER BEFORE PLANTING TO ASSURE THAT PROPER DRAINAGE AND PERCOLATION IS AVAILABLE. CORRECT IF REQUIRED TO ASSURE PERCOLATION. CONTRACTOR IS RESPONSIBLE FOR REPLACEMENT OF ALL PLANTS LOST DUE TO INADEQUATE DRAINAGE CONDITIONS.
8. ALL PLANTED AREAS SHALL BE MULCHED WITH 3" LOOSE MEASURE OF APPROVED MULCH.
9. CONTRACTOR TO GUARANTEE PLANT MATERIAL THRU WRITTEN WARRENTY TO OWNER FOR A PERIOD OF 12 MONTHS AFTER DATE OF SUBSTANTIAL COMPLETION.
10. CONTRACTOR TO REQUEST INSPECTION OF PROJECT IN WRITING. IF ALL WORK IS SATISFACTORY AND COMPLETE IN ACCORDANCE WITH CONDITIONS OF CONTRACT DOCUMENTS, THEN THE LANDSCAPE ARCHITECT SHALL DECLARE THE PROJECT SUBSTANTIALLY COMPLETE.
11. CONTRACTOR TO REPLACE REJECTED PLANT MATERIAL WITHIN TWO WEEKS OF NOTICE. CONTRACTOR IS TO FAMILIARIZE HIMSELF WITH THE LAYOUT, GRADING AND CIVIL ENGINEERING DOCUMENTS TO COORDINATE ACTUAL LOCATION OF TREES AND SHRUBS. OBTAIN THE LANDSCAPE ARCHITECT'S APPROVAL OF FINISH GRADING PRIOR TO THE START OF PLANTING.
12. ANY PROPOSED SUBSTITUTIONS OF PLANT SPECIES SHALL BE APPROVED BY THE LANDSCAPE ARCHITECT AND THE OWNER'S REPRESENTATIVE PRIOR TO DELIVERY TO THE SITE.
13. STAKE LOCATIONS OF ALL PROPOSED TREES FOR APPROVAL BY THE ARCHITECT AND THE OWNER'S REPRESENTATIVE PRIOR TO THE COMMENCEMENT OF PLANTING.
14. SEE SPECIFICATIONS FOR PLANTING REQUIREMENTS, SOIL PREPARATION TESTING, MATERIALS, EXECUTION, AND MAINTENANCE.
15. SEE DETAILS AND SPECIFICATIONS FOR STAKING METHOD, PLANT PIT DIMENSIONS AND BACKFILL REQUIREMENTS. TREE STAKING SHALL BE REMOVED 1 YEAR POST WARRENTY.
16. CONTRACTOR SHALL NOTIFY OWNER'S REPRESENTATIVE 48 HOURS PRIOR TO COMMENCEMENT OF WORK TO COORDINATE PROJECT INSPECTION SCHEDULES.
17. ALL TREES OF THE SAME SPECIES AND SIZE SHALL HAVE MATCHING HEIGHT AND FORM UNLESS OTHERWISE NOTED ON THE PLANS.
18. IF CONFLICTS ARISE BETWEEN SIZE OF AREAS AND PLANS, CONTRACTOR SHALL CONTACT OWNER'S REPRESENTATIVE FOR IMMEDIATE RESOLUTION. FAILURE TO MAKE SUCH CONFLICTS KNOWN TO THE OWNER'S REPRESENTATIVE WILL RESULT IN CONTRACTOR'S LIABILITY TO RELOCATE THE MATERIALS.
19. CONTRACTOR IS RESPONSIBLE TO DO THEIR OWN QUANTITY TAKEOFFS FOR ALL PLANT MATERIALS AND SIZES SHOWN ON PLANS. SUPPLY ALL PLANT MATERIAL IN QUANTITIES SUFFICIENT TO COMPLETE THE PLANTING BED AS SHOWN ON THE DRAWINGS.
20. PLANT CROWN ELEVATIONS RELATIVE TO FINISH GRADE ARE SHOWN ON PLANTING DETAILS AND SHALL BE STRICTLY ADHERED TO. PROPER COMPACTION OF BACKFILL TO PREVENT SETTLEMENT SHALL BE REQUIRED.
21. THE LANDSCAPE CONTRACTOR SHALL COORDINATE WITH THE DESIGN LANDSCAPE ARCHITECT REGARDING THE REQUIRED SOIL ANALYSIS REPORT AND IS RESPONSIBLE FOR COMPLETING THE SOIL SAMPLING AND SUBMITTING THE SAMPLES TO A SOILS TESTING LAB FOR TESTING. THIS WOULD INCLUDE A SEPARATE LAB TEST REPORT AND RECOMMENDATIONS (AMENDMENT/FERTILIZER AMOUNTS AND APPLICATION RATES) FOR EACH TYPE OF PROPOSED LANDSCAPING (SHRUB BEDS/SOD/NATIVE SEED). THE SOILS LAB RESULTS AND RECOMMENDATIONS ARE REQUIRED TO BE REVIEWED AND APPROVED BY THE DESIGN LANDSCAPE ARCHITECT AND THE CITY OF COLORADO SPRINGS PRIOR TO INSTALLING ANY LANDSCAPING (PLANTS/SOD/NATIVE SEED) ONSITE.
22. THE LANDSCAPE ARCHITECT RESERVES THE RIGHT TO ADJUST THE LOCATION OF PLANT MATERIAL DURING INSTALLATION AS APPROPRIATE TO THE PROJECT.
23. ALL LANDSCAPED AREAS SHALL BE IRRIGATED WITH A WATER EFFICIENT IRRIGATION SYSTEM. ALL TURF GRASS AREAS WILL BE ON SPRINKLED WITH STREAM-SPRAY WATER SAVING SPRINKLER ZONES, AND ALL PLANTING AREAS WILL BE WATERED WITH A POINT-SOURCE DRIP IRRIGATION SYSTEM. ALL IRRIGATION WILL BE CONTROLLED BY A MASTER CONTROL VALVE WITH A RAIN-SENSOR MODULE.
24. AN IRRIGATION PLAN SHALL BE SUBMITTED AND REVIEWED CONCURRENT WITH THE BUILDING PERMIT SUBMITTAL, AND APPROVED PRIOR TO ISSUANCE OF A BUILDING PERMIT.
25. LANDSCAPE IMPROVEMENT AND MAINTENANCE SHALL BE THE RESPONSIBILITY OF THE OWNER, AND/OR THEIR ASSIGNS

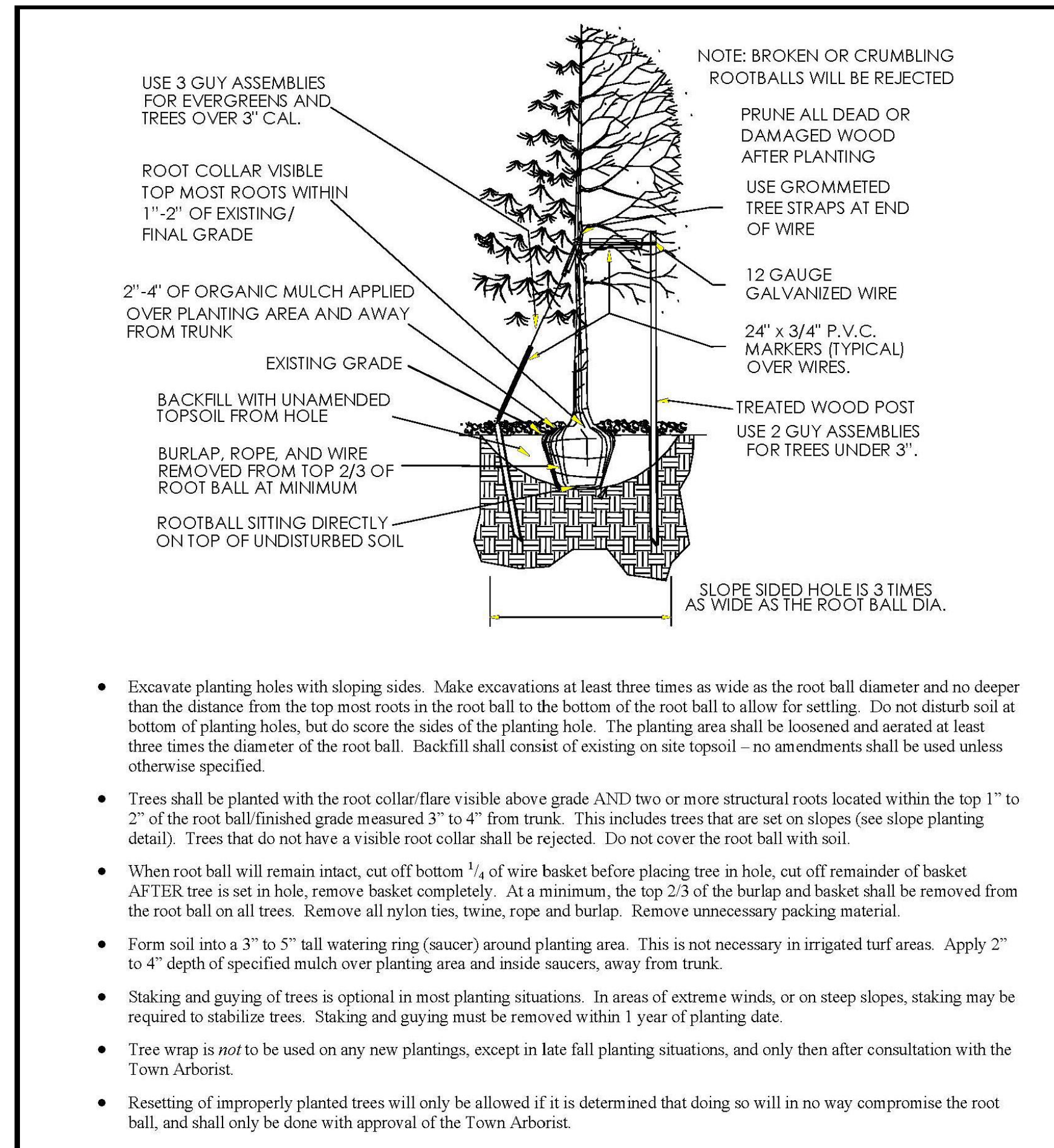

A TOWN OF PARKER TREE PLANTING DETAIL

Scale: NTS

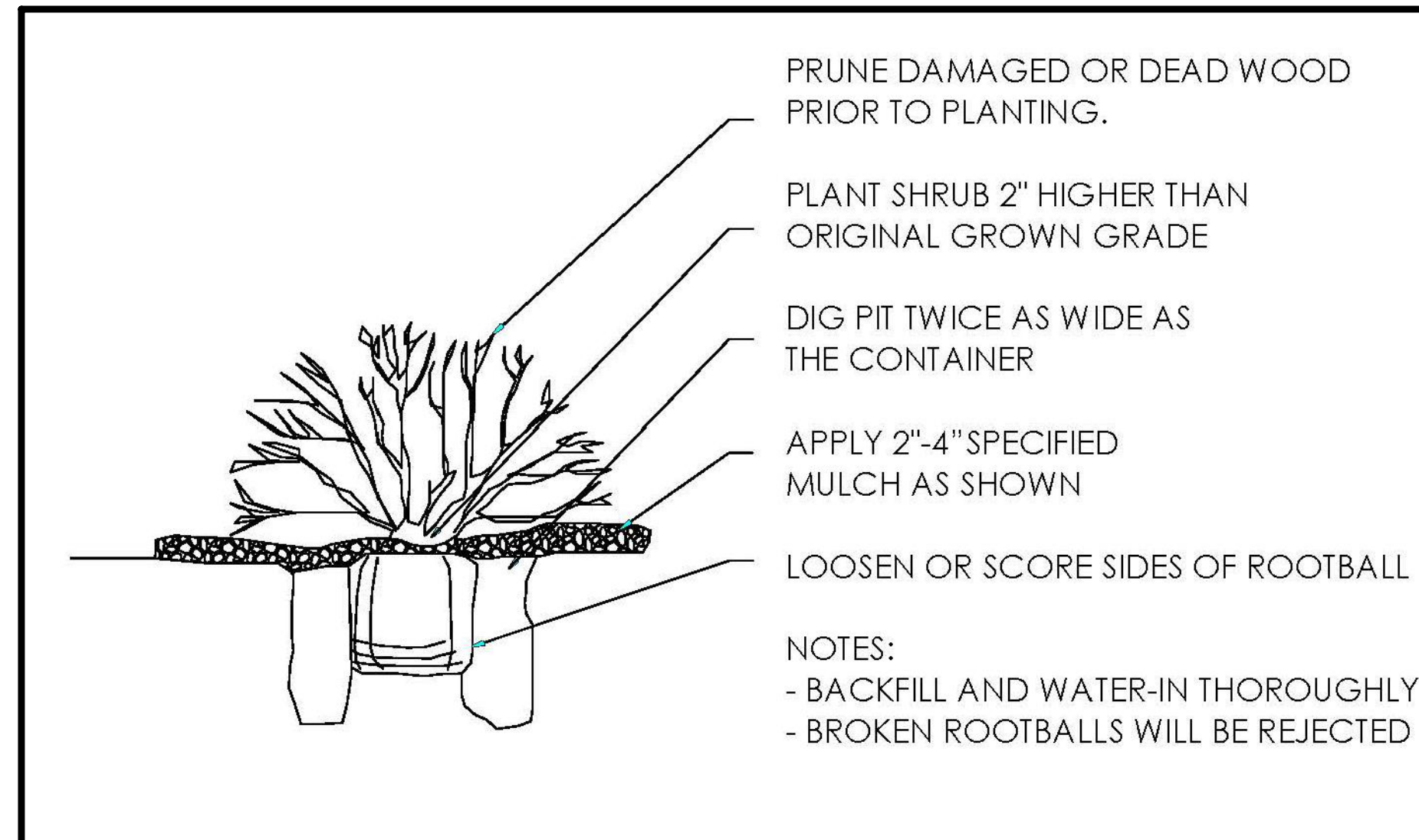

B TOWN OF PARKER SHRUB PLANTING DETAIL

Scale: NTS

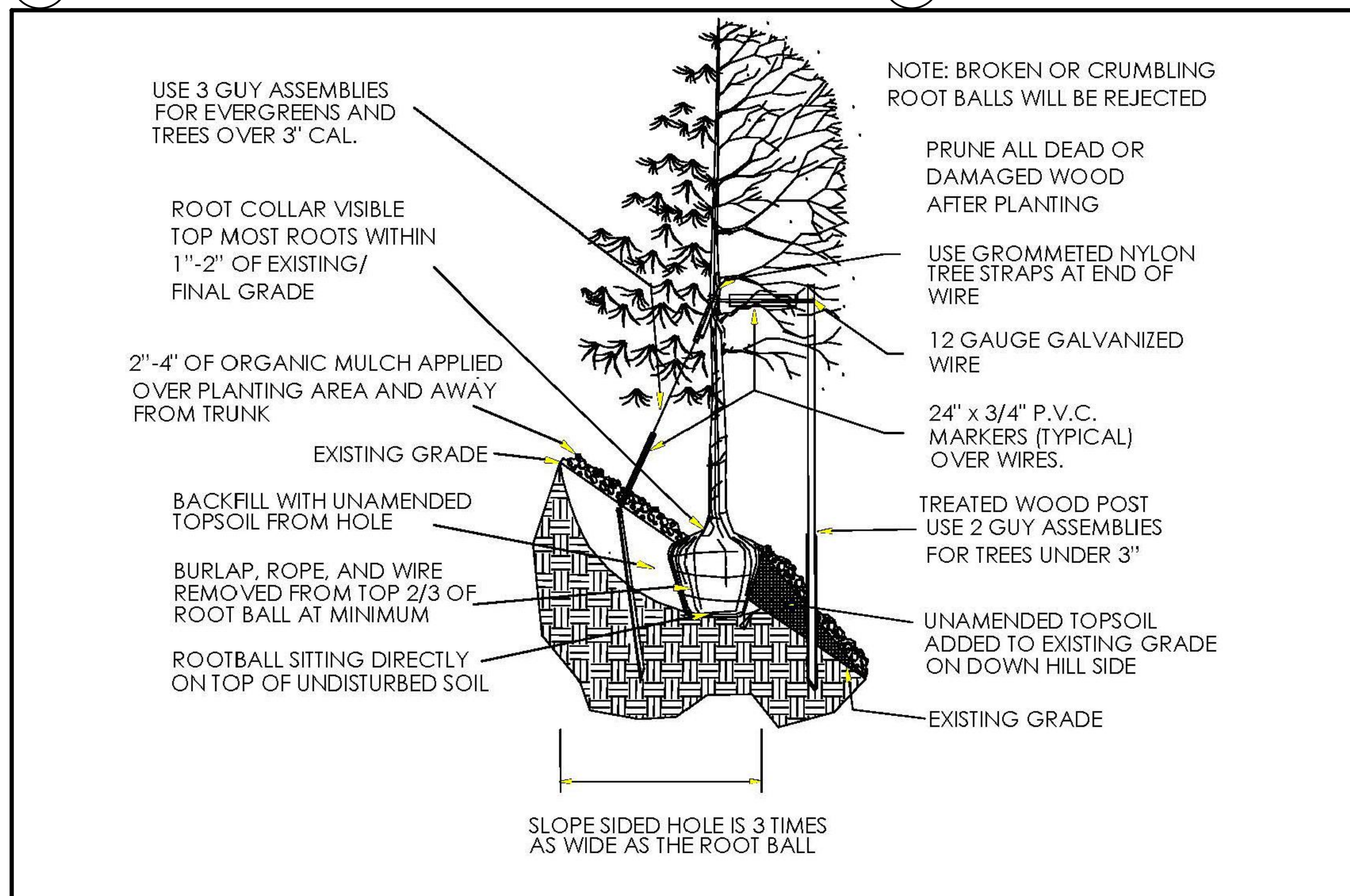

C TOWN OF PARKER TREE PLANTING ON SLOPE DETAIL

Scale: NTS

MAVERIK INC. STORE
 LINCOLN AVE. AND DRANSFELDT RD.
 PARKER, CO

EDCI
 ENGINEERS
 1331 17TH STREET • SUITE 605
 DENVER, COLORADO 80202
 PHONE: (720) 439-4700
 WEBSITE: www.edci-engineers.com
 CIVIL / STRUCTURAL
 Google Earth Photo Access by Right to Life Team

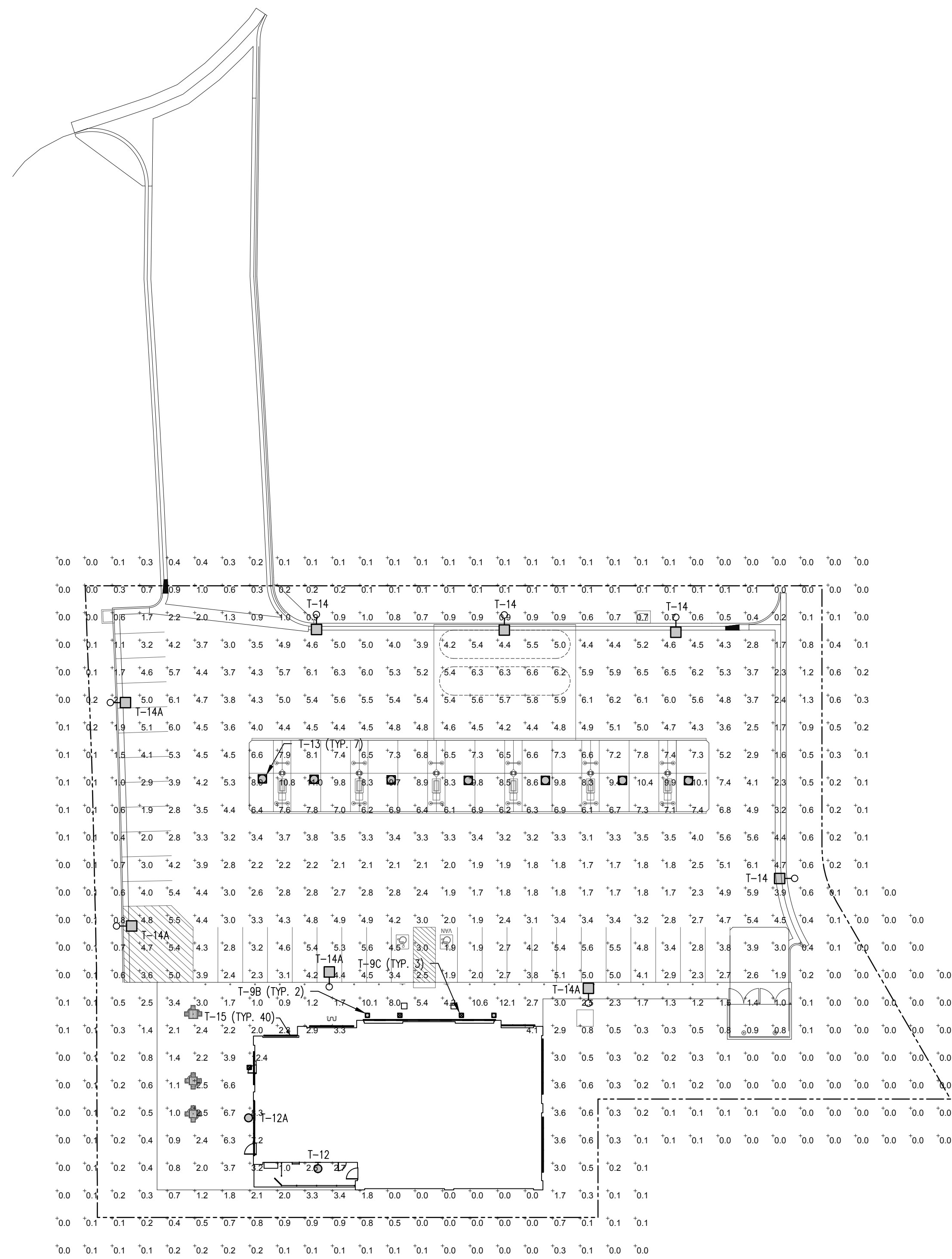

1 SITE PHOTOMETRIC PLAN
 E-1.2 SCALE: 1"=30'-0"

MASTER LUMINAIRE SCHEDULE									
TYPE	MANUFACTURER	CATALOG NUMBER	VOLTS	MOUNTING	LAMPS	BALLAST	WATTS	IMAGE	
DESCRPT: RECESSED WHITE LED DOWNLIGHT 6" APERTURE, 1300 LUMENS, 4K									
T-9B	LOTUS LED	LL6RR 40K WH	120	RECESSED	INCLUDED		18		
T-9C	SAME AS T-9B EXCEPT WITH EMERGENCY BATTERY							18	
DESCRPT: LOW PROFILE, FULL CUTOFF WALL PACK, LED, DARK BRONZE, 4K, 3144 LUMENS									
T-12	LSI	XVM 3 LED 03 40 UE BRZ	120	WALL	INCLUDED		23		
				HEIGHT SPECIFIED BY ARCHITECT					
T-12A SAME AS T-12 EXCEPT WITH 08 LUMEN PACKAGE AND TYPE IV DISTRIBUTION (FORWARD THROW)									
DESCRPT: CANOPY MOUNTED, CUTOFF LUMINAIRE, 103W LED, FLAT LENS, FOR SINGLE DECK CANOPIES (10,209 LUMENS)									
T-13	LSI	SCV LED 10L SC UNV DIM 40 WHT	UNV	CANOPY	INCLUDED		67		
DESCRPT: POLE MOUNTED, CUTOFF LUMINAIRE SINGLE HEAD, LED, 18,930 LUMENS, 17.5FT SQUARE POLE (4", 11 GA.), 4K									
T-14	LSI	SLM LED 18L SIL 3 UNV 40 70 CRI BRZ	208	17'-6" POLE	INCLUDED		135		
T-14A SAME AS T-14 EXCEPT WITH TYPE IV DISTRIBUTION (FORWARD THROW)									
DESCRPT: 4FT LED STRIP LUMINAIRE, COLD WEATHER (0F), 2000 LUMENS, DAMP LISTED, LENS (1.78" WIDTH), 4K									
T-15	LSI	MLS4 LED 20L CSM UNV DIM U	UNV	EXTERIOR COVE	INCLUDED		20		

*LUMINAIRES ARE PROVIDED BY OWNER, INSTALLED BY E.C. (REFERENCE SCHEDULE ON E-4.0)

CALCULATION SUMMARY								
AREA NAME	GRID / TYPE	SPAC	GROUP	AVE	MAX	MIN	MAX/MIN	AVE./MIN
OVERALL	0'-0" / H-H	10.00	<+>	2.4	12.4	0.00	N/A	N/A
PARKING	0'-0" / H-H	10.00	<+>	4.0	8.9	1.6	5.6:1	2.5:1

185 S. State Street
 Salt Lake City, Utah 84111

THESE PLANS ARE SUBJECT TO FEDERAL COPYRIGHT LAWS. ANY USE OF SAME WITHOUT THE EXPRESSED WRITTEN PERMISSION OF MAVERIK, INC IS PROHIBITED. 2019 MAVERIK, INC.

ARCHITECT:

ENGINEER:

Nielson Engineering, Inc.
 Consulting Engineers
 156 North Twelfth Avenue
 Provo, Utah 84601
 Ph (208) 232-2577 FAX
 (208) 234-0918

OWNERSHIP OF DOCUMENTS
 This document, including the ideas and designs incorporated herein, as an instrument of professional service, is the property of NIELSON ENGINEERING, INC. and shall not be used, in whole or in part, for any other project without the written permission of an authorized representative of NIELSON ENGINEERING, INC. Unauthorized use will be prosecuted to the full extent of the law.
 Copyright © 2021
 by: NIELSON ENGINEERING, INC.

STAMP:

MAVERIK, INC.
 STORE #

LINCOLN AVENUE AND
 DRANSFELDT ROAD
 PARKER, CO

REVISIONS

DESCRIPTION	DATE

DESIGNED BY: MJE	DRAWN BY: MJE
REVIEWED BY: MJE	APPROVED BY: MSI
PROTOTYPE VERSION: 50	
DRAWING ISSUE	
DATE: 12-18-20	
PROJECT NUMBER: 20337	
SHEET NAME	
PHOTOMETRIC PLAN	
SHEET NUMBER	
E-1.2	

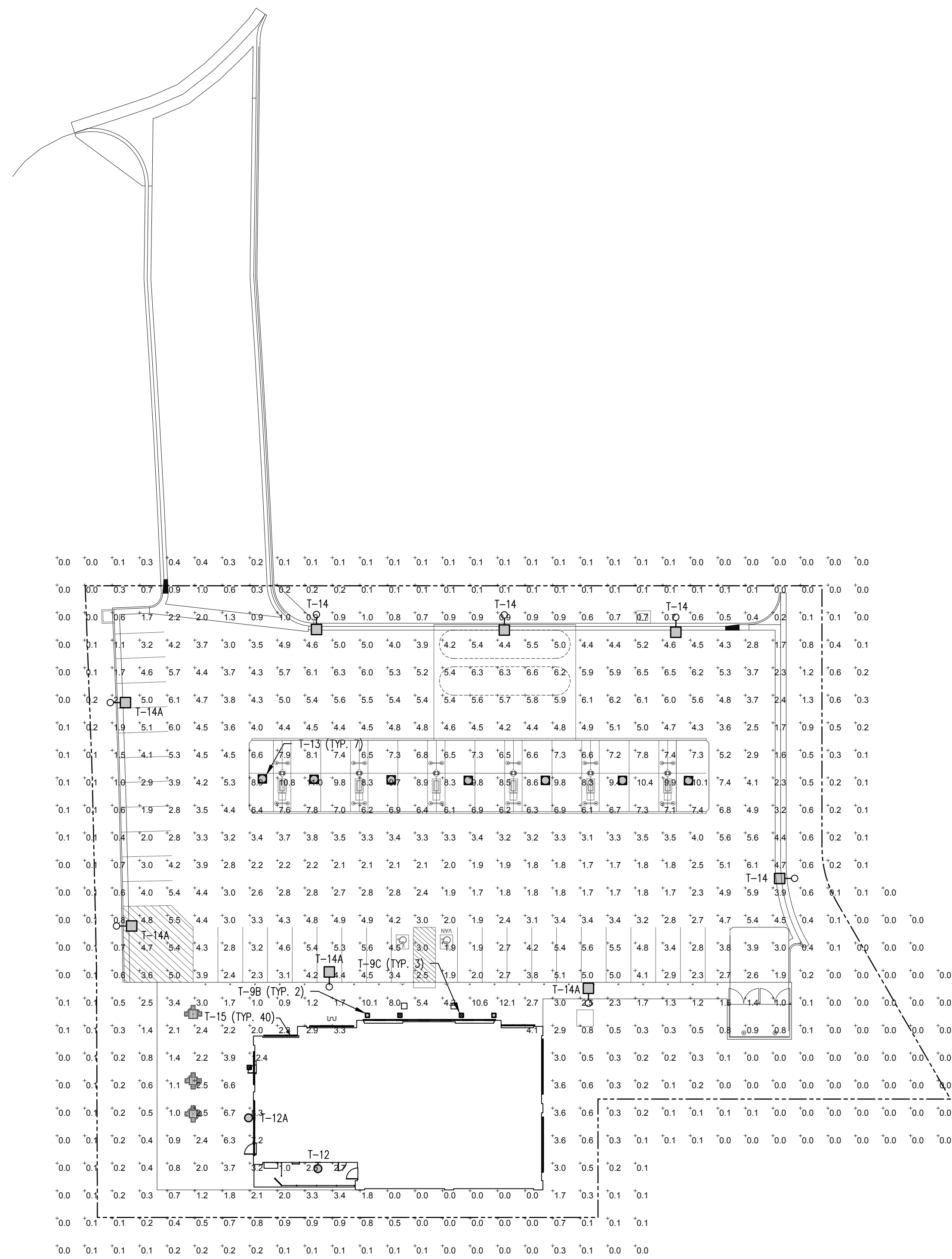

1 SITE PHOTOMETRIC PLAN
 E-1.2 SCALE: 1"=30'-0"

MASTER LUMINAIRE SCHEDULE									
TYPE	MANUFACTURER	CATALOG NUMBER	VOLTS	MOUNTING	LAMPS	BALLAST	WATTS	IMAGE	
DESCRPT: RECESSED WHITE LED DOWNLIGHT 6" APERTURE, 1300 LUMENS, 4K									
T-9B	LOTUS LED	LL6RR 40K WH	120	RECESSED	INCLUDED		18		
T-9C	SAME AS T-9B EXCEPT WITH EMERGENCY BATTERY							18	
DESCRPT: LOW PROFILE, FULL CUTOFF WALL PACK LED, DARK BRONZE, 4K, 3144 LUMENS									
T-12	LSI	XVM 3 LED 03 40 UE BRZ	120	WALL	INCLUDED		23		
T-12A SAME AS T-12 EXCEPT WITH 08 LUMEN PACKAGE AND TYPE IV DISTRIBUTION (FORWARD THROW)									
DESCRPT: CANOPY MOUNTED, CUTOFF LUMINAIRE, 103W LED, FLAT LENS, FOR SINGLE DECK CANOPIES (10,209 LUMENS)									
T-13	LSI	SCV LED 10L SC UNV DIM 40 WHT	UNV	CANOPY	INCLUDED		67		
DESCRPT: POLE MOUNTED, CUTOFF LUMINAIRE SINGLE HEAD, LED, 18,930 LUMENS, 17.5FT SQUARE POLE (4", 11 GA.), 4K									
T-14	LSI	SLM LED 18L SIL 3 UNV 40 70 CRI BRZ	208	17'-6" POLE	INCLUDED		135		
T-14A SAME AS T-14 EXCEPT WITH TYPE IV DISTRIBUTION (FORWARD THROW)									
DESCRPT: 4FT LED STRIP LUMINAIRE, COLD WEATHER (0F), 2000 LUMENS, DAMP LISTED, LENS (1.78" WIDTH), 4K									
T-15	LSI	MLS4 LED 20L CSM UNV DIM U	UNV	EXTERIOR COVE	INCLUDED		20		

*LUMINAIRES ARE PROVIDED BY OWNER, INSTALLED BY E.C. (REFERENCE SCHEDULE ON E-4.0)

CALCULATION SUMMARY								
AREA NAME	GRID / TYPE	SPAC	GROUP	AVE	MAX	MIN	MAX/MIN	AVE/MIN
OVERALL	0'-0" / H-H	10.00	<+>	2.4	12.4	0.00	N/A	N/A
PARKING	0'-0" / H-H	10.00	<+>	4.0	8.9	1.6	5.6:1	2.5:1

185 S. State Street
Salt Lake City, Utah 84111

THESE PLANS ARE SUBJECT TO FEDERAL COPYRIGHT LAWS. ANY USE OF SAME WITHOUT THE EXPRESSED WRITTEN PERMISSION OF MAVERIK, INC IS PROHIBITED. 2019 MAVERIK, INC.

ARCHITECT:

ENGINEER:

Nielson Engineering, Inc.
Consulting Engineers
156 North Twelfth Avenue
Pocahontas, Idaho 83201
Ph (208) 232-2577 FAX
(208) 234-0918

OWNERSHIP OF DOCUMENTS
This document, including the ideas and designs incorporated herein, as an instrument of professional service, is the property of NIELSON ENGINEERING, INC. and shall not be used, in whole or in part, for any other project without the written permission of an authorized representative of NIELSON ENGINEERING, INC. Unauthorized use will be prosecuted to the full extent of the law.
Copyright © 2021
by: NIELSON ENGINEERING, INC.

STAMP:

MAVERIK, INC.
STORE #

LINCOLN AVENUE AND
DRANSFELDT ROAD
PARKER, CO

REVISIONS	
DESCRIPTION	DATE

DESIGNED BY: MJE	DRAWN BY: MJE
REVIEWED BY: MJE	APPROVED BY: MSI
PROTOTYPE VERSION: 50	
DRAWING ISSUE	
DATE: 12-18-20	
PROJECT NUMBER: 20337	
SHEET NAME	
PHOTOMETRIC PLAN	
SHEET NUMBER	
E-1.2	

Type IC, Wet, Air-Tight & Open Plenum
DESCRIPTION

8" Round Deep Regressed LED - Elegant Design Without Glare
Commercial Grade Quality Built To Last

FEATURES & BENEFITS

18W & 30W High Output versions with CRI 90+
Type IC, Air-Tight & Wet - No Housing Required
4 1/2" Deep - Install Where Ceiling Space Is Limited
Armored Cable & Metal Connectors - Open Plenum Rated
Driver Inside Connection Box with Romex Quick Connectors
and Knock Outs - Fast Installation & No Junction Box Needed

DIMENSIONS ID 7 1/2" OD 9" Cut Out 7 1/2" to 8"

Ceiling Clearance Required: 4"

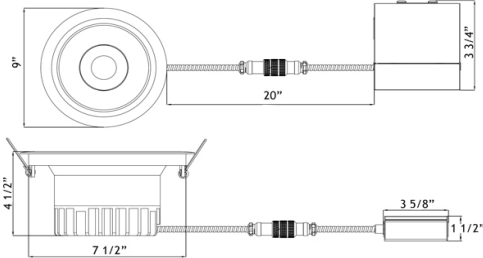

120V TRIAC Dimmable Driver Included



Optional 120V-347V Driver 0-10V Dimmable



Order Separately as

18W: Cat # LLL-LD2050TR

30W: Cat # LLL-LD3580TR

ORDERING GUIDE:

Example 18W **LD8R-30K-WR-WT**

Example 30W **LD8R-30K-HO-WR-WT**

	CCT	30W only	Reflector-Trim
LD8R	- xxK	- HO	- xx-xx
3000K	- 30K		WR-WT
3500K	- 35K		SR-WT
4000K	- 40K		BR-BT
5000K	- 50K		SR-BT
DTW 3K-2K	- 32K		

8" Round Deep Regressed LED 18W / 30W Open Plenum

Project: LD8R-40K-HO-BR-BT 8" Round Deep Regressed LED 30W Open Plenum,
30w 2900 lumens (black) - RIP8 - 7 1/2" Hole 26" Flat Rough-in Plate

Location: _____

Cat #: _____

Qty: _____

Notes: _____

SPECIFICATION

Applications	Recessed Ceiling Mount	
Energy Used	15W Regular / 18W High Output	
Color Temperature (K)	3000 3500 4000 5000 DTW 3-2	
Light Output 18W (lm)	1550 1600 1650 1700 1150	
Light Output 30W (lm)	2700 2900	
Beam Angle	38°	
CRI	90 +	
Default Driver Input	120V AC	Triac Dimmable
Optional Driver Input	120V-347V AC	0-10V Dimmable
Junction Box Wire Capacity	Max 5 No 12 AWG or 8 No 14 AWG	
Power Factor	0.98	
Approved Location	Insulated Ceilings, Open Plenum, Wet	
IP Rating	IP 54	
Air Tight	Yes	
Ambient Temperature	-40°F (-40°C) to +104°F (+40°C)	
Projected Life	70% Light Output at 50,000 Hours	
Certification	cULus, Energy Star (except DTW), T24	
Warranty	10 Year Residential / 5 Year Commercial	

AVAILABLE TRIMS

White Reflector
White Trim
WR-WT



Silver Reflector
White Trim
SR-WT



Black Reflector
Black Trim
BR-BT



Silver Reflector
Black Trim
SR-BT

ACCESSORIES

Sold Separately



Armored Low Voltage Extension
10ft cat # **MEC10**



Flat Rough-In Plates - cat # **RIP8**



Goof Ring White OD 9 1/2" cat # **GR8**

Goof Ring White OD 10 1/2" cat # **GR810**

COMPLIANCE

Type IC
Air - Tight
Open Plenum

Type IC, Wet, Air-Tight & Open Plenum
DESCRIPTION

8" Round Deep Regressed LED - Elegant Design Without Glare
Commercial Grade Quality Built To Last

FEATURES & BENEFITS

18W & 30W High Output versions with CRI 90+
Type IC, Air-Tight & Wet - No Housing Required
4 1/2" Deep - Install Where Ceiling Space Is Limited
Armored Cable & Metal Connectors - Open Plenum Rated
Driver Inside Connection Box with Romex Quick Connectors
and Knock Outs - Fast Installation & No Junction Box Needed

DIMENSIONS ID 7 1/2" OD 9" Cut Out 7 1/2" to 8"

Ceiling Clearance Required: 4"

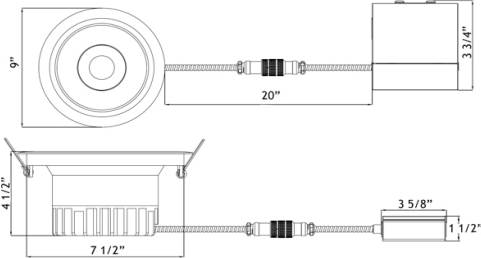
120V TRIAC Dimmable Driver Included

Optional 120V-347V Driver 0-10V Dimmable

Order Separately as

18W: Cat # LLL-LD2050TR
30W: Cat # LLL-LD3580TR

ORDERING GUIDE:

 Example 18W **LD8R-30K-WR-WT**

 Example 30W **LD8R-30K-HO-WR-WT**

	CCT	30W only	Reflector-Trim
LD8R	- xxK	- HO	- xx-xx
3000K	- 30K		WR-WT
3500K	- 35K		SR-WT
4000K	- 40K		BR-BT
5000K	- 50K		SR-BT
DTW 3K-2K	- 32K		

8" Round Deep Regressed LED 18W / 30W Open Plenum

LD8R-40K-HO-BR-BT 8" Round Deep Regressed LED 30W Open Plenum, 30w
Project: 2900 lumens (black) - RIP8 - 7 1/2" Hole 26" Flat Rough-in Plate with EM backup

Location: _____

Cat #: _____

Qty: _____

Notes: _____

SPECIFICATION

Applications	Recessed Ceiling Mount	
Energy Used	15W Regular / 18W High Output	
Color Temperature (K)	3000 3500 4000 5000 DTW 3-2	
Light Output 18W (lm)	1550 1600 1650 1700 1150	
Light Output 30W (lm)	2700 2900	
Beam Angle	38°	
CRI	90 +	
Default Driver Input	120V AC	Triac Dimmable
Optional Driver Input	120V-347V AC	0-10V Dimmable
Junction Box Wire Capacity	Max 5 No 12 AWG or 8 No 14 AWG	
Power Factor	0.98	
Approved Location	Insulated Ceilings, Open Plenum, Wet	
IP Rating	IP 54	
Air Tight	Yes	
Ambient Temperature	-40°F (-40°C) to +104°F (+40°C)	
Projected Life	70% Light Output at 50,000 Hours	
Certification	cULus, Energy Star (except DTW), T24	
Warranty	10 Year Residential / 5 Year Commercial	

AVAILABLE TRIMS

White Reflector
White Trim
WR-WT



Silver Reflector
White Trim
SR-WT



Black Reflector
Black Trim
BR-BT



Silver Reflector
Black Trim
SR-BT

ACCESSORIES

Sold Separately



Armored Low Voltage Extension
10ft cat # **MEC10**

 Flat Rough-In Plates - cat # **RIP8**

 Goof Ring White OD 9 1/2" cat # **GR8**

 Goof Ring White OD 10 1/2" cat # **GR810**
COMPLIANCE

Type IC
Air - Tight
Open Plenum

MIRADA WALL SCNCE (XWM)



DOE LIGHTING FACTS

Department of Energy has verified representative product test data and results in accordance with its Lighting Facts Program. Visit www.lightingfacts.com for specific catalog strings.

LIGHT OUTPUT - XWM - 3 5000K CCT			
	Lumens	Wattage	LPW
03	3410	29	117
04	4417	40	111
06	6609	59	113
08	8610	82	105

LED Chips are frequently updated therefore values may increase.

COVERAGE DIAGRAM

SIDE VIEW

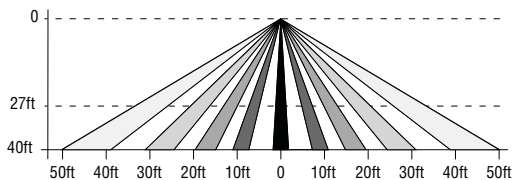

TOP VIEW

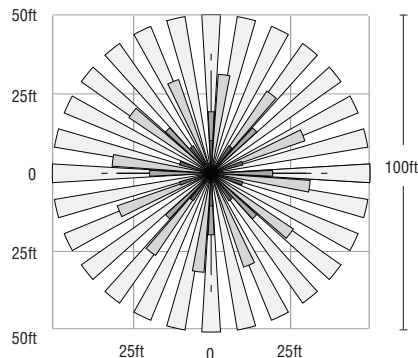

US & Int'l. patents pending

SMARTTEC™ -LSI drivers feature integral sensor which reduces drive current, when ambient temperatures exceed rated temperature

ENERGY SAVING CONTROL OPTIONS - DIM - 0-10 volt dimming enabled with LSI wireless controls.

OPTIONAL INTEGRAL MOTION SENSOR - Passive infrared motion sensor activates switching of luminaire light levels. High level light is activated when passersby enter target zone and increased to full bright in 1-2 seconds. Low light level (30% of maximum drive current) is activated when target zone is absent of motion activity for 5 minutes and is gradually ramped down (10 seconds) to low level. Sensor detection range 110° horizontal x 93° vertical x 10 meters maximum distance.

LEDS - Available with 5000K, 4000K or 3000K color temperature, 70 CRI min.

OPTICS/DISTRIBUTIONS - Ultra-high efficiency reflectors provide three distributions. Choose from Type 2, Type 3 or Type FT.

HOUSING - Three-piece die-cast aluminum housing is smoothly contoured low-profile shape. Mounting hardware is stainless steel or electro-zinc plated steel. Housing and optical unit are sealed with extruded silicone gasket; supply conductors with molded EPDM bushing.

OPTICAL UNIT - Proprietary silicone refractor optics provide exceptional coverage and uniformity. Pressure stabilizing breather allows super-tight protection while preventing cycling from building up internal pressures and vacuums that can stress optical unit seals

WALL MOUNTING - Galvanized-steel universal wall mounting plate easily mounts directly to 4" octagonal or square junction box. EPDM gasket is supplied to be installed between mounting plate and junction box, sealing junction box from entrance of water. Universal plate permits fixture to be mounted in uplighting (indoor only) or downlighting position. Optional pole-mounting bracket permits mounting to standard poles (XPMa).

ELECTRICAL - Two-stage surge protection (including separate surge protection built into electronic driver) meets IEEE C62.41.2-2002, Location Category C. Available with universal voltage power supply 120-277VAC (50/60Hz input) or 347-480VAC.

DRIVER - Drivers are dimming, standard. Components are fully encased in potting material for IP65 moisture resistance. Driver complies with IEC and FCC standards. Driver can be easily accessed.

EMERGENCY OPTIONS - Optional integral emergency battery-back-up options are available. BB option operates in 0°C to 60°C ambient temperature and CWBB operates in -20°C to 60°C ambient temperature. When primary AC power failure occurs, both options operate 10 LEDs for minimum of 90 minutes.

OPERATING TEMPERATURE - -40°C to +50°C (-40°F to +122°F)

FINISH - Fixtures are finished with LSI's DuraGrip® polyester powder coat finishing process. The DuraGrip finish withstands extreme weather changes without cracking or peeling.

WARRANTY - LSI LED fixtures carry a limited 5-year warranty.

PHOTOMETRICS - Please visit our web site at www.lsi-industries.com for detailed photometric data.

SHIPPING WEIGHT (in carton) - 30 lbs./13.6Kg

LISTING - UL listed to ANSI/UL1598, UL8750 and other U.S. and international safety standards. Suitable for wet locations in downlight position.

This product, or selected versions of this product, meet the standards listed below. Please consult factory for your specific requirements.



MIRADA WALL SCNCE (XWM)

LUMINAIRE ORDERING INFORMATION

TYPICAL ORDER EXAMPLE: **XWM FT LED 08L 50 UE WHT IMS**

Prefix	Distribution	Light Source	Output ⁸	Color Temperature	Input Voltage	Finish	Optional Controls	Optional Sensor/Options
XWM - Mirada Wall Sconce	2 - Type 2 3 - Type 3 (Wide Throw) FT - Type 4 (Forward Throw)	LED	03L - 3,400 Lumens 04L - 4,400 Lumens 06L - 6,600 Lumens 08L - 8,600 Lumens	50 - 5000K 40 - 4000K 30 - 3000K	UE - Universal Voltage (120-277) HV - 347-480	BLK - Black BRZ - Bronze GPT - Graphite MSV - Metallic Silver PLP - Platinum Plus WHT - White	Wireless Control System^{1,2} (blank) - None PCM - Platinum Control System GCM - Gold Control System DIM - 0-10 volt dimming (required for satellite fixtures) ALSC - AirLink Synapse Control System Stand-Alone Control (blank) - None DIM - 0-10 volt dimming ³ (from external signal)	Sensor IMS - Integral Motion Sensor ^{4,7} Options BB - Battery Back-up ⁵ CWBB - Cold Weather Battery Back-up ⁵ XPMA - Pole Mounting Bracket

ACCESSORY ORDERING INFORMATION ¹ (Accessories are field installed)			
Description	Order Number	Description	Order Number
XWM SW BLK - Surface Wiring Box (Available in black only)	356915BLK	DFK208 - Double Fusing	DFK208
FK120 - Single Fusing	FK120	DFK240 - Double Fusing	DFK240
FK277 - Single Fusing	FK277	DFK480 - Double Fusing	DFK480
FK347 - Single Fusing	FK347	IMS/PC Remote Configurator Tool ⁷	584929

- FOOTNOTES:**
- 1 - For wireless controls information and accessories, see Controls Section.
 - 2 - Requires a SiteManager and override switch. Not compatible with battery back-up, IMS or HL Option.
 - 3 - Not compatible with IMS Option
 - 4 - Not compatible with DIM or Wireless Control System
 - 5 - Not compatible with Wireless Control System
 - 6 - Not available with BB, CWBB, IMS Option or Wireless Control System
 - 7 - IMS is the WattStopper Dual Sensor (Daylight & Motion) which is field adjustable, via a handheld remote configurator tool⁷
 - 8 - Output based on type 3 optics in cool white color temperature, see IES files for exact delivered lumens

DIMENSIONS

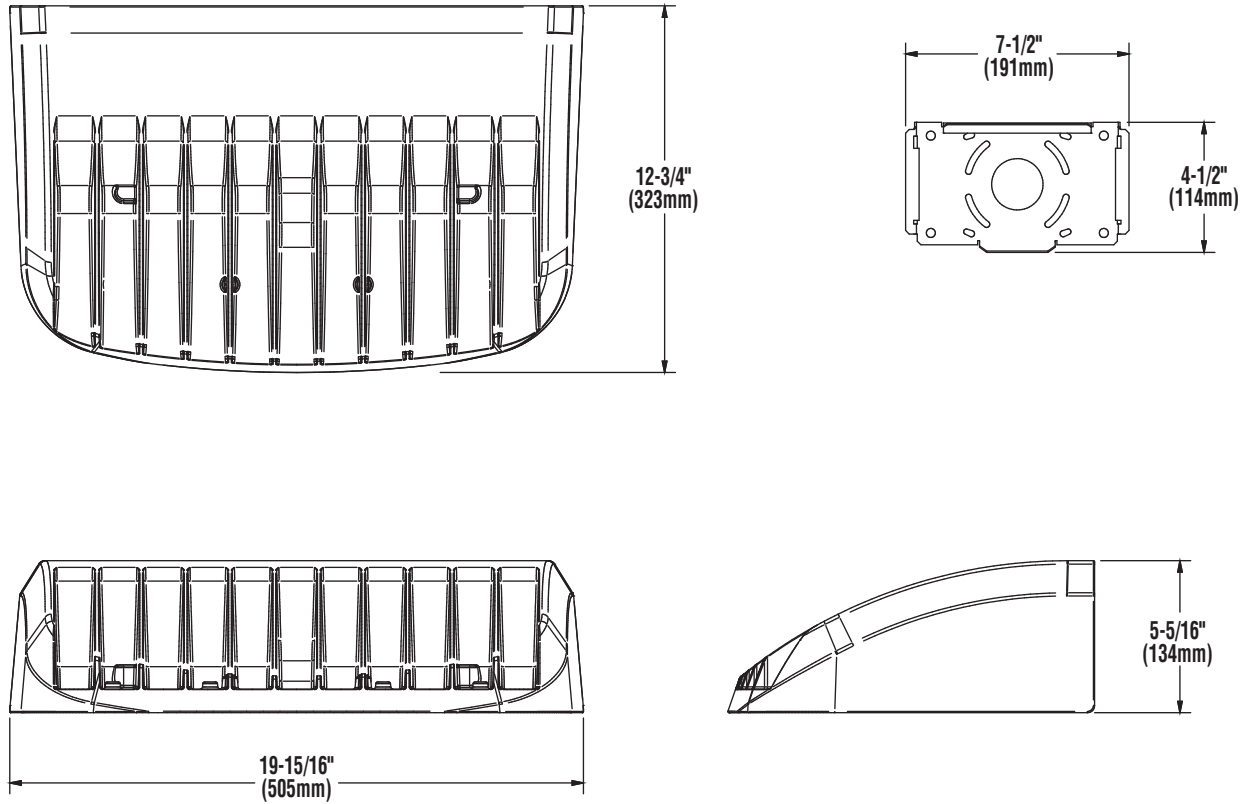



AirLink™

enabled by Synapse®

Wireless Lighting Controller

The AirLink integrated controller is a California Title 24 compliant lighting controller that provides real-time light monitoring and control with utility-grade power monitoring. It includes a 24V sensor input and power supply to connect up to two (2) sensors into the outdoor AirLink wireless lighting system.

Features

- 2% Utility Grade Power Monitoring
- Up to 80% Savings through smart dimming
- True On/Off functionality via switched relay
- Seamlessly integrates into the outdoor AirLink wireless lighting control solution & Self-healing Mesh Networking
- Relay closes on power loss
- Supports a wide range of LED drivers and fixtures
- Class 1 / Class 2 0-10V Dimming Control
- Direct Connect up to two (2) to 24V Occupancy Sensors and Photocells (consult sales for compatible list)
- Secure, over-the-air upgrades to support future enhancements
- Excellent RF Range — 1,000ft LoS between controllers
- Available in a metal cased version with quick connect terminal blocks
- Lights default to on for safety

Specifications

Regulatory Approvals

- FCC, IC, CE certified
- cULus Listed
- California Title 24 compliant

Power and Performance

- Operating environmental: -40°F to 131°F (-40°C to 55°C)
- Input power: 100–277 VAC +/- 10% (Max 305V) 47/64 Hz
- Switched output: Default ON; Zero Cross Switching
- Load rating: 5A @ 100V to 277V (+/- 10%)
- Dimming: 0–10V control; Output: Class 1/2 - 20mA Source Max / 50mA Sink Max
- Power monitoring: Utility grade - 2% accuracy
- Sensors inputs: 0–10V (photocell sensors), 0–24V (all other sensors); Sensor power supply: 24VDC @ 50mA

Other

- Dimensions: 8.2" L x 2.3" W x 1.3" H (209mm L x 59mm W x 33mm H) without antennas
- Radio: SNAP 2.4 GHz; 802.15.4; +20 dBm Transmit Power; -105 dBm Receive Sensitivity
- Warranty: 5 years

Contact LSI Controls



Sales
controls.sales@lsi-industries.com



Support
controls.support@lsi-industries.com
1 (800) 436-7800 (support, option 8)



More information
For more information on AirLink, visit our website at www.lsi-airlink.com/airlink

MIRADA WALL SCNCE (XWM)



DOE LIGHTING FACTS

Department of Energy has verified representative product test data and results in accordance with its Lighting Facts Program. Visit www.lightingfacts.com for specific catalog strings.

LIGHT OUTPUT - XWM - 3 5000K CCT

	Lumens	Wattage	LPW
03	3410	29	117
04	4417	40	111
06	6609	59	113
08	8610	82	105

LED Chips are frequently updated therefore values may increase.

COVERAGE DIAGRAM

SIDE VIEW

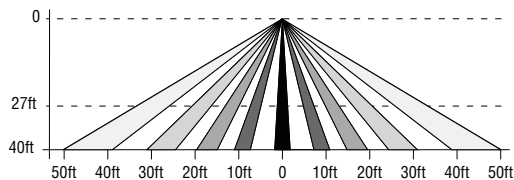

TOP VIEW

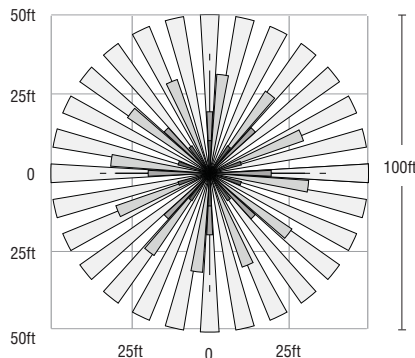

US & Int'l. patents pending

SMARTTEC™ -LSI drivers feature integral sensor which reduces drive current, when ambient temperatures exceed rated temperature

ENERGY SAVING CONTROL OPTIONS - DIM - 0-10 volt dimming enabled with LSI wireless controls.

OPTIONAL INTEGRAL MOTION SENSOR - Passive infrared motion sensor activates switching of luminaire light levels. High level light is activated when passersby enter target zone and increased to full bright in 1-2 seconds. Low light level (30% of maximum drive current) is activated when target zone is absent of motion activity for 5 minutes and is gradually ramped down (10 seconds) to low level. Sensor detection range 110° horizontal x 93° vertical x 10 meters maximum distance.

LEDS - Available with 5000K, 4000K or 3000K color temperature, 70 CRI min.

OPTICS/DISTRIBUTIONS - Ultra-high efficiency reflectors provide three distributions. Choose from Type 2, Type 3 or Type FT.

HOUSING - Three-piece die-cast aluminum housing is smoothly contoured low-profile shape. Mounting hardware is stainless steel or electro-zinc plated steel. Housing and optical unit are sealed with extruded silicone gasket; supply conductors with molded EPDM bushing.

OPTICAL UNIT - Proprietary silicone refractor optics provide exceptional coverage and uniformity. Pressure stabilizing breather allows super-tight protection while preventing cycling from building up internal pressures and vacuums that can stress optical unit seals

WALL MOUNTING - Galvanized-steel universal wall mounting plate easily mounts directly to 4" octagonal or square junction box. EPDM gasket is supplied to be installed between mounting plate and junction box, sealing junction box from entrance of water. Universal plate permits fixture to be mounted in uplighting (indoor only) or downlighting position. Optional pole-mounting bracket permits mounting to standard poles (XPMA).

ELECTRICAL - Two-stage surge protection (including separate surge protection built into electronic driver) meets IEEE C62.41.2-2002, Location Category C. Available with universal voltage power supply 120-277VAC (50/60Hz input) or 347-480VAC.

DRIVER - Drivers are dimming, standard. Components are fully encased in potting material for IP65 moisture resistance. Driver complies with IEC and FCC standards. Driver can be easily accessed.

EMERGENCY OPTIONS - Optional integral emergency battery-back-up options are available. BB option operates in 0°C to 60°C ambient temperature and CWBB operates in -20°C to 60°C ambient temperature. When primary AC power failure occurs, both options operate 10 LEDs for minimum of 90 minutes.

OPERATING TEMPERATURE - -40°C to +50°C (-40°F to +122°F)

FINISH - Fixtures are finished with LSI's DuraGrip® polyester powder coat finishing process. The DuraGrip finish withstands extreme weather changes without cracking or peeling.

WARRANTY - LSI LED fixtures carry a limited 5-year warranty.

PHOTOMETRICS - Please visit our web site at www.lsi-industries.com for detailed photometric data.

SHIPPING WEIGHT (in carton) - 30 lbs./13.6Kg

LISTING - UL listed to ANSI/UL1598, UL8750 and other U.S. and international safety standards. Suitable for wet locations in downlight position.

This product, or selected versions of this product, meet the standards listed below. Please consult factory for your specific requirements.



Project Name MAVERIK

Fixture Type T12A

10/20/17

Catalog # XWM FT LED 08 40 UE BRZ

© 2017
LSI INDUSTRIES INC.

MIRADA WALL SCNCE (XWM)

LUMINAIRE ORDERING INFORMATION

TYPICAL ORDER EXAMPLE: **XWM FT LED 08L 50 UE WHT IMS**

Prefix	Distribution	Light Source	Output ⁸	Color Temperature	Input Voltage	Finish	Optional Controls	Optional Sensor/Options
XWM - Mirada Wall Sconce	2 - Type 2 3 - Type 3 (Wide Throw) FT - Type 4 (Forward Throw)	LED	03L - 3,400 Lumens 04L - 4,400 Lumens 06L - 6,600 Lumens 08L - 8,600 Lumens	50 - 5000K 40 - 4000K 30 - 3000K	UE - Universal Voltage (120-277) HV - 347-480	BLK - Black BRZ - Bronze GPT - Graphite MSV - Metallic Silver PLP - Platinum Plus WHT - White	Wireless Control System^{1,2} (blank) - None PCM - Platinum Control System GCM - Gold Control System DIM - 0-10 volt dimming (required for satellite fixtures) ALSC - AirLink Synapse Control System Stand-Alone Control (blank) - None DIM - 0-10 volt dimming ³ (from external signal)	Sensor IMS - Integral Motion Sensor ^{4,7} Options BB - Battery Back-up ⁵ CWBB - Cold Weather Battery Back-up ⁵ XPMA - Pole Mounting Bracket

ACCESSORY ORDERING INFORMATION¹ (Accessories are field installed)

Description	Order Number	Description	Order Number
XWM SW BLK - Surface Wiring Box (Available in black only)	356915BLK	DFK208 - Double Fusing	DFK208
FK120 - Single Fusing	FK120	DFK240 - Double Fusing	DFK240
FK277 - Single Fusing	FK277	DFK480 - Double Fusing	DFK480
FK347 - Single Fusing	FK347	IMS/PC Remote Configurator Tool ⁷	584929

FOOTNOTES:

- 1 - For wireless controls information and accessories, see Controls Section.
- 2 - Requires a SiteManager and override switch. Not compatible with battery back-up, IMS or HL Option.
- 3 - Not compatible with IMS Option
- 4 - Not compatible with DIM or Wireless Control System
- 5 - Not compatible with Wireless Control System
- 6 - Not available with BB, CWBB, IMS Option or Wireless Control System
- 7 - IMS is the WattStopper Dual Sensor (Daylight & Motion) which is field adjustable, via a handheld remote configurator tool⁷
- 8 - Output based on type 3 optics in cool white color temperature, see IES files for exact delivered lumens

DIMENSIONS

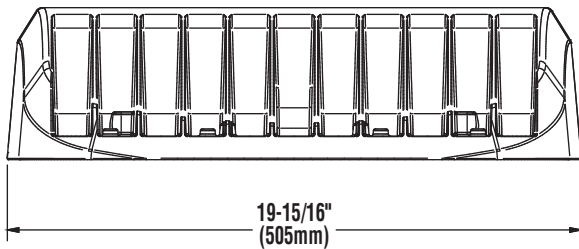
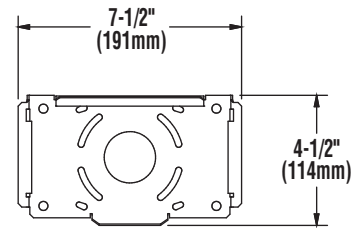
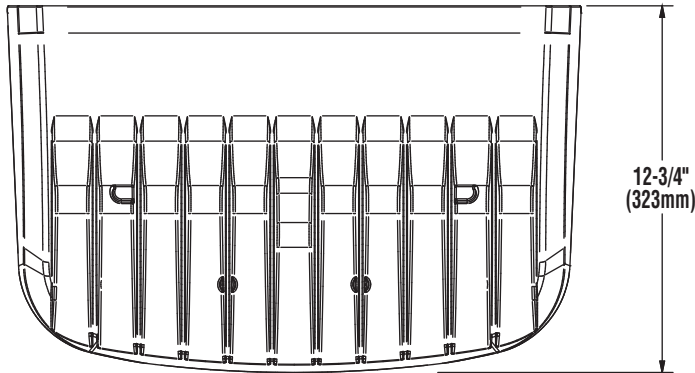



AirLink™

enabled by Synapse®

Wireless Lighting Controller

The AirLink integrated controller is a California Title 24 compliant lighting controller that provides real-time light monitoring and control with utility-grade power monitoring. It includes a 24V sensor input and power supply to connect up to two (2) sensors into the outdoor AirLink wireless lighting system.

Features

- 2% Utility Grade Power Monitoring
- Up to 80% Savings through smart dimming
- True On/Off functionality via switched relay
- Seamlessly integrates into the outdoor AirLink wireless lighting control solution & Self-healing Mesh Networking
- Relay closes on power loss
- Supports a wide range of LED drivers and fixtures
- Class 1 / Class 2 0-10V Dimming Control
- Direct Connect up to two (2) to 24V Occupancy Sensors and Photocells (consult sales for compatible list)
- Secure, over-the-air upgrades to support future enhancements
- Excellent RF Range — 1,000ft LoS between controllers
- Available in a metal cased version with quick connect terminal blocks
- Lights default to on for safety

Specifications

Regulatory Approvals

- FCC, IC, CE certified
- cULus Listed
- California Title 24 compliant

Power and Performance

- Operating environmental: -40°F to 131°F (-40°C to 55°C)
- Input power: 100–277 VAC +/- 10% (Max 305V) 47/64 Hz
- Switched output: Default ON; Zero Cross Switching
- Load rating: 5A @ 100V to 277V (+/- 10%)
- Dimming: 0–10V control; Output: Class 1/2 - 20mA Source Max / 50mA Sink Max
- Power monitoring: Utility grade - 2% accuracy
- Sensors inputs: 0–10V (photocell sensors), 0–24V (all other sensors); Sensor power supply: 24VDC @ 50mA

Other

- Dimensions: 8.2" L x 2.3" W x 1.3" H (209mm L x 59mm W x 33mm H) without antennas
- Radio: SNAP 2.4 GHz; 802.15.4; +20 dBm Transmit Power; -105 dBm Receive Sensitivity
- Warranty: 5 years

Contact LSI Controls



Sales
controls.sales@lsi-industries.com



Support
controls.support@lsi-industries.com
1 (800) 436-7800 (support, option 8)



More information
For more information on AirLink, visit our website at www.lsi-airlink.com/airlink



Scottsdale Vertex™ (SCV)

Petroleum Canopy LED Luminaire



OVERVIEW

Lumen Package	9,000 - 24,000
Wattage Range	66 - 192
Efficacy Range (LPW)	119 - 156
Weight lbs(kg)	15 (6.8)

QUICK LINKS

[Ordering Guide](#)
[Performance](#)
[Photometrics](#)
[Dimensions](#)

FEATURES & SPECIFICATIONS

Construction

- Rugged low-profile die-cast aluminum housing, optical unit, and driver cover.
- Below canopy access to optical chamber and driver housing for serviceability.
- IP66 rated optical unit protects integral components from dust and water.
- Fixtures are finished with LSI's DuraGrip® polyester powder coat finishing process. The DuraGrip finish withstands extreme weather changes without cracking or peeling.
- A single fastener secures access door to driver and key components and provides quick & easy access to the electrical compartment for servicing.
- Shipping weight: 15 lbs in carton.

Optical System

- Proprietary silicone refractor optics provide exceptional coverage and uniformity in Symmetrical or Combination Forward Throw distributions.
- State-of-the-art silicone optics deliver industry leading optical control with an integrated gasket to provide an IP66 rated sealed optical chamber in one component.
- Silicone optical material does not yellow or crack with age and provides a minimum light transmittance of 93%.
- Available in 5000K and 4000K (+/- 275K) color temperatures.
- Minimum CRI of 70.

Electrical

- High-performance driver features over-voltage, under-voltage, short-circuit and over temperature protection.
- 0-10V dimming (10% - 100%) standard.
- Standard Universal Voltage (120-277 Vac) Input 50/60 Hz or optional High Voltage (347-480 Vac).
- L80 Calculated Life: >100k Hours (See Lumen Maintenance on Page 2)

- Total harmonic distortion: <20%
- Operating temperature: -40°C to +50°C (-40°F to +122°F) when mounted to Steel/ Aluminum surfaces for 10L, 13L, & 15L Lumen Packages, +45°C for 20L Lumen Package, and +40°C for 23L Lumen Package. If mounted to a non-metallic surface, reduce ambient by 5°C.
- Power factor: >0.90
- Field replaceable surge protection device meets a minimum Category C Low operation (per ANSI/IEEE C62.41.2).
- High-efficacy LEDs are mounted to (4) circuit boards to maximize heat dissipation
- Driver components are fully encased in potting material for moisture resistance. Driver complies with FCC standards.

Hazardous Location

- Designed for lighter than air fuel applications. Product is suitable for Class 1 Division 2 with all lumen packages and distributions only when properly installed per LSI installation instructions. Models with optional controls are not approved for Class 1, Division 2 applications.

T5 Temperature Classification - The surface temperature of this product will not rise above 100°C., within a 40°C ambient.

Gas Groups A,B,C, and D - Group A: Acetylene / Group B: Hydrogen / Group C: Propane and Ethylene / Group D: Benzene, Butane, Methane & Propane.

Installation

- Installs in a 12" or 16" deck pan.
- Four fasteners are provided with the fixture for using deck, metallic canopy substrates only when classified as suitable for use by installing professional otherwise suitable fasteners should be provided by others.
- Unit is designed to quickly retrofit into existing Scottsdale (4") hole.

- Aluminum locking collar and gasket are included and required for complete seal and support of canopy deck.
- Retrofit panels are available for existing Encores, Richmond, 2x2 Universal, and more.

Warranty

- LSI LED Fixtures carry a 5-year warranty or 10-year warranty with registration for petroleum applications only (contact your LSI representative for details).

Listings

- Listed to UL 1598 and UL 8750.
- RoHS Compliant.
- Meets Buy American Act requirements.
- State of California Title 24 Compliant with IMSBT or ALSC/ALSCS option.
- IP66 Rated Optical Unit per IEC 60598.
- DesignLights Consortium® (DLC) qualified product. Not all versions of this product may be DLC qualified. Please check the DLC Qualified Products List at www.designlights.org/QPL to confirm which versions are qualified.





ORDERING GUIDE

[Back to Quick Links](#)

TYPICAL ORDER EXAMPLE: **SCV LED 13L SC UNV DIM 50 WHT IMSBT2**

Family / Size	LED Gen	Lumen Package	Distribution	Voltage	Driver	Color Temperature	Finish	Controls
SCV - Petroleum Canopy Luminaire	LED	10L - 10000 Lumens 13L - 13000 Lumens 15L - 15000 Lumens 20L - 20000 Lumens 23L - 23000 Lumens	SC - Standard Symmetric	UNV - 120-277V HV - 347-480V	DIM - Dims to 10% (0 to 10V dimming)	40 - 4000K 50 - 5000K	WHT - White BLK - Black BRZ - Bronze	Blank - NONE ALSC - AirLink Synapse Wireless Control System ¹ ALSCS - AirLink Synapse Wireless Control System with Sensor ¹ ALBCS1 - AirLink Blue Wireless Motion & Photo Sensor Controller (8-24' mounting height) ⁵ ALBCS2 - AirLink Blue Wireless Motion & Photo Sensor Controller (25-40' mounting height) ⁵ IMSBT1 - Integral Bluetooth™ Motion and Photocell Sensor 8 - 24' mounting height ^{2,5} IMSBT2 - Integral Bluetooth™ Motion and Photocell Sensor 25 - 40' mounting height ^{2,5}
		23L - 23000 Lumens	SCFT - Combination Standard Symmetric and Forward Throw					

Accessory Ordering Information

Description	Order Number	Description	Order Number
Retrofit Panel Kit - EC / ECTA / SCF to SCV, for 16" Deck Panel with larger openings ³	673425	26" X 32" Beauty Plate Kit (with 4" Center hole)	564160WHT
Retrofit Panel Kit - EC / ECTA / SCF to SCV, for 12" Deck Panel ⁴	676011	Junction Box	687461
Retrofit Panel Kit - RECU Richmond to SCV	673426	Kit - Hole Plugs and Sealant (enough for 25 retrofits)	1320540
Retrofit Panel Kit - UNV Universal 2x2 to SCV	673427	Rectangular Top Plate Kit (includes top plate and sealant)	678291WHT
Retrofit 2x2 Cover Panel Blank (no holes)	357282	Surface Mount Box	673433
Retrofit RIC Cover Panel Blank (no holes)	354702	Retrofit Kit - CRU/CRUS to SCV	687462
26" X 26" Beauty Plate Kit (with 4" Center hole)	557193WHT		

FOOTNOTES:

- 1 - Consult factory for HV with AirLink Synapse Wireless Control System.
- 2 - IMSBT is field configurable via the LSI app that can be downloaded from your smartphone's native app store.

- 3 - Ideal for 9" to 12" openings.
- 4 - Ideal for 9" openings.
- 5 - Not available in HV.

PERFORMANCE

[Back to Quick Links](#)

DELIVERED LUMENS										
Drive Current	3000K CCT			4000K CCT			5000K CCT			Wattage
	Delivered Lumens	Efficiency	BUG Ratings	Delivered Lumens	Efficiency	BUG Ratings	Delivered Lumens	Efficiency	BUG Ratings	
10L	8723	132	B3-U0-G1	10218	156	B3-U0-G1	10306	156	B3-U0-G1	66
13L	10921	130	B3-U0-G1	12793	153	B3-U0-G1	12933	153	B3-U0-G1	84
15L	12984	125	B3-U0-G1	15209	150	B3-U0-G1	15411	150	B3-U0-G1	103
20L	17145	132	B3-U0-G1	20083	153	B4-U0-G2	20141	155	B4-U0-G2	130
23L	19338	126	B4-U0-G2	22652	149	B4-U0-G2	23150	152	B4-U0-G2	153
23L (SCFT)	22778	119	B3-U0-G3	24581	128	B4-U0-G3	24361	127	B3-U0-G3	192

*LEDs are frequently updated therefore values are nominal.

ELECTRICAL DATA*						
Lumen Level	120V	208V	240V	277V	347V	480V
10L	0.55	0.32	0.28	0.24	0.19	0.14
13L	0.70	0.41	0.35	0.30	0.24	0.18
15L	0.86	0.50	0.43	0.37	0.30	0.21
20L	1.09	0.63	0.54	0.47	0.38	0.27
23L (SC)	1.27	0.73	0.64	0.55	0.44	0.32
23L (SCFT)	1.60	0.92	0.80	0.69	0.55	0.40

*Electrical data at 25°C (77°F)

SC DISTRIBUTION RECOMMENDED LUMEN MAINTENANCE ¹					
Ambient Temperature C	Lumen Multiplier				
	0 hrs. ²	25K hrs. ²	50K hrs. ²	75K hrs. ²	100K hrs. ²
25	1.00	0.96	0.92	0.88	0.84
30	1.00	0.96	0.91	0.87	0.83
35	1.00	0.96	0.91	0.87	0.83
40	1.00	0.96	0.91	0.87	0.83
45	1.00	0.96	0.91	0.87	0.82

SCFT DISTRIBUTION RECOMMENDED LUMEN MAINTENANCE ¹					
Ambient Temperature C	Lumen Multiplier				
	0 hrs. ²	25K hrs. ²	50K hrs. ²	75K hrs. ²	100K hrs. ²
25	1.00	1.00	1.00	0.99	0.99
30	1.00	1.00	0.99	0.99	0.99
35	1.00	1.00	0.99	0.99	0.99
40	1.00	1.00	0.99	0.99	0.99

- Lumen maintenance values at 25°C are calculated per TM-21 based on LM-80 data and in-situ luminaire testing.
- In accordance with IESNA TM-21-11, Projected Values represent interpolated value based on time durations that are within six times (6X) the IESNA LM-80-08 total test duration (in hours) for the device under testing ((DUT) i.e. the packaged LED chip).
- In accordance with IESNA TM-21-11, Calculated Values represent time durations that exceed six times NA LM-80-08 total test duration (in hours) for the device under testing ((DUT) i.e. the packaged LED chip).





PHOTOMETRICS

[Back to Quick Links](#)

Luminaire photometry has been conducted by an accredited testing laboratory in accordance with IESNA LM-79-08. As specified by IESNA LM-79-08 the entire luminaire is tested as the source resulting in a luminaire efficiency of 100%.

See <http://www.lsi-industries.com/products/led-lighting-solutions.aspx> for detailed photometric data.

SCV-LED-15L-SC-50

LUMINAIRE DATA

Wide Distribution	
Description	5000 Kelvin, 70 CRI
Delivered Lumens	15,410
Watts	103
Efficacy	150
IES Type	Type VS - Very Short
BUG Rating	B3-U0-G1

Zonal Lumen Summary

Zone	Lumens	%Luminaire
Low (0-30)°	4101.6	26.6%
Medium (30-60)°	8386.4	54.4%
High (60-80)°	2748.8	17.8%
Very High (80-90)°	173.4	1.1%
Uplight (90-180)°	0.0	0.0%
Total Flux	15410.2	100%

ISOFOOT CANDLE PLOT

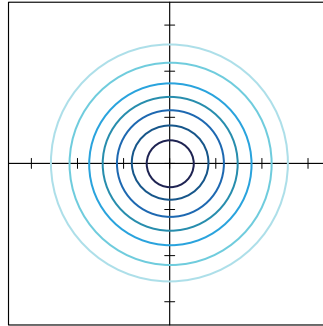

15' Mounting Height / 10' Grid Spacing

10 FC 5 FC 2 FC 1 FC

POLAR CURVE

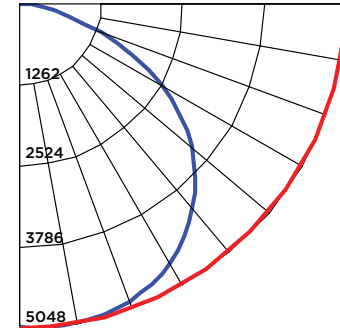

SCV-LED-23L-SCFT-50

LUMINAIRE DATA

Wide Distribution	
Description	5000 Kelvin, 70 CRI
Delivered Lumens	24,361
Watts	191.5
Efficacy	127
IES Type	Type IV - Short
BUG Rating	B3-U0-G3

Zonal Lumen Summary

Zone	Lumens	%Luminaire
Low (0-30)°	4368.4	17.9%
Medium (30-60)°	12592.5	51.7%
High (60-80)°	6960.6	28.6%
Very High (80-90)°	439.5	1.8%
Uplight (90-180)°	0.0	0.0%
Total Flux	24361.0	100%

ISOFOOT CANDLE PLOT

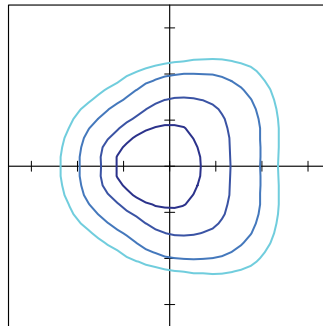

15' Mounting Height / 10' Grid Spacing

10 FC 5 FC 2 FC 1 FC

POLAR CURVE

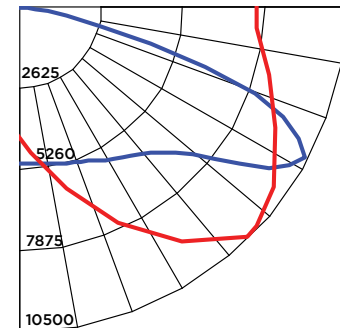

CANOPY COMPARISON									
Canopy Layout	Fixture	QTY	Fixture Lumens	Fixture Watts	Lumens/Watts	Canopy/Watts	Canopy Watts/Sq. Ft.	*Canopy/Avg.	*Transition Area Avg.
1	SCV-LED-13L-SC-50	18	12,933	84.3	153	1,717	0.39	35.41	3.43
2	SCV-LED-10L-SC-50	12	10,306	66.1	156	1,942	0.50	34.34	9.58
	SCV-LED-23L-SCFT-50	6	24,361	191.5	127				
3	SCV-LED-13L-SC-50	12	12,933	84.3	153	2,161	0.56	39.43	9.70
	SCV-LED-23L-SCFT-50	6	24,361	191.5	127				
4	SCV-LED-15L-SC-50	12	15,410	103.0	150	2,385	0.62	44.23	9.80
	SCV-LED-23L-SCFT-50	6	24,361	191.5	127				
5	SCV-LED-20L-SC-50	12	20,141	130.3	155	2,713	0.70	53.38	10.03
	SCV-LED-23L-SCFT-50	6	24,361	191.5	127				
6	SCV-LED-23L-SC-50	12	23,150	152.5	152	2,979	0.77	59.22	10.16
	SCV-LED-23L-SCFT-50	6	24,361	191.5	127				

*Initial foot-candle values at grade.

(18) 13L Symmetrical Fixtures

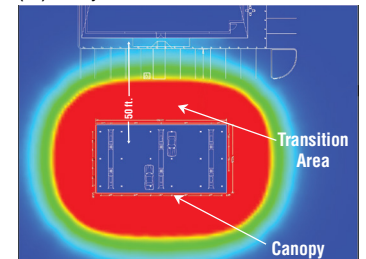

(12) Symmetrical AND (6) Combo FT Fixtures

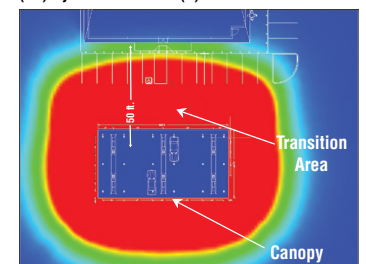



PRODUCT DIMENSIONS

[Back to Quick Links](#)

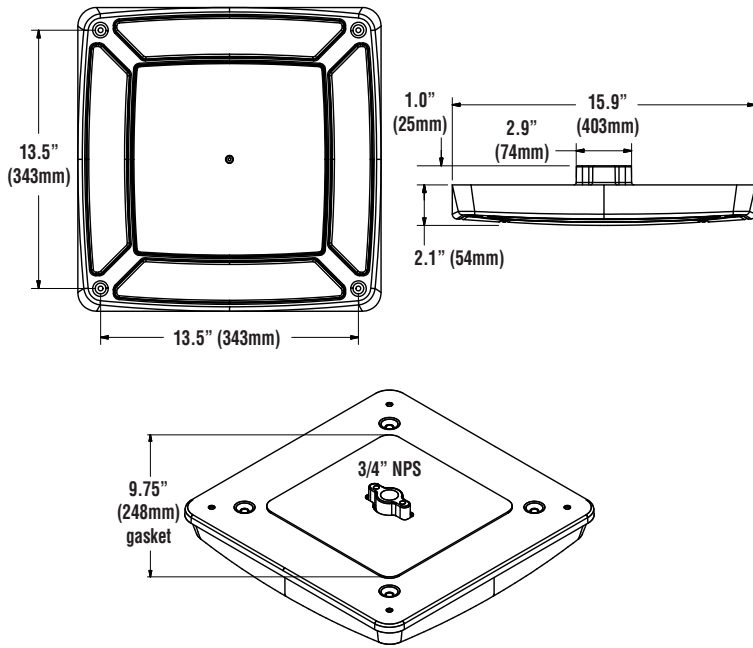

Luminaire Shown with IMSBT Option

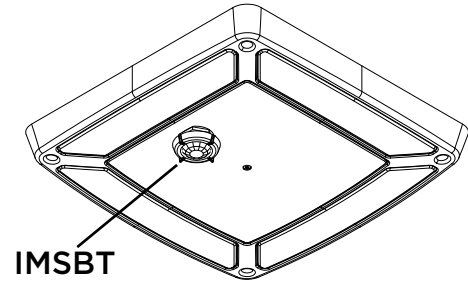

CONTROLS

AirLink Wireless Lighting Controller

The AirLink integrated controller is a California Title 24 compliant lighting controller that provides real-time light monitoring and control with utility-grade power monitoring. It includes a 24V sensor input and power supply to connect a sensor into the outdoor AirLink wireless lighting system.

The wireless integrated controller is compatible with this fixture.

Click the link below to learn more details about AirLink.

<https://www.lsi-industries.com/documents/datasheets/airlink-outdoor-specsheet.pdf>

Integral Bluetooth™ Motion and Photocell Sensor (IMSBT)

Slim low profile sensor provides multi-level control based on motion and/or daylight. Sensor controls 0-10 VDC LED drivers and is rated for cold and wet locations (-30° C to 70° C). Two unique PIR lenses are available and used based on fixture mounting height. All control parameters are adjustable via an iOS or Android App capable of storing and transmitting sensor profiles.

Click the link below to learn more details about IMSBT.

<https://www.lsi-industries.com/documents/datasheets/imsbt-specsheet.pdf>

AirLink™ Blue

Wireless Bluetooth Mesh Outdoor Lighting Control System that provides energy savings, code compliance and enhanced safety/security for parking lots and parking garages. Three key components; Bluetooth wireless radio/sensor controller, Time Keeper and an iOS App. Capable of grouping multiple fixtures and sensors as well as scheduling time-based events by zone. Radio/Sensor Controller is factory integrated into Area/Site, Wall Mounted, Parking Garage and Canopy luminaires.

Click the link below to learn more details about AirLink Blue.

<https://www.lsi-airlink.com/airlink-blue/>

RETROFIT KITS

LSI Industries offers a full line of Retrofit Kits for existing Encore, Richmond, 2x2 Universal and many more older canopy luminaires.

Click the link below to see more details on all our Retrofit Kits.

<https://www.lsi-industries.com/documents/datasheets/scv-petro-retrofit-specsheet.pdf>





Slice Medium (SLM)

Outdoor LED Area Light



OVERVIEW

Lumen Package	9,000 - 42,000
Wattage Range	69 - 390
Efficacy Range (LPW)	93 - 145
Weight lbs(kg)	30 (13.6)

QUICK LINKS

[Ordering Guide](#)
[Performance](#)
[Photometrics](#)
[Dimensions](#)

FEATURES & SPECIFICATIONS

Construction

- Rugged die-cast aluminum housing contains factory prewired driver and optical unit. Cast aluminum wiring access door located underneath.
- Designed to mount to square poles.
- Fixtures are finished with LSI's DuraGrip® polyester powder coat finishing process. The DuraGrip finish withstands extreme weather changes without cracking or peeling. Other standard LSI finishes available. Consult factory.
- Shipping weight: 30 lbs in carton.

Optical System

- State-of-the-Art one piece silicone optic sheet delivers industry leading optical control with an integrated gasket to provide IP66 rated sealed optical chamber in 1 component.
- Proprietary silicone refractor optics provide exceptional coverage and uniformity in IES Types 2, 3, 5W, FT, FTA and AM.
- Silicone optical material does not yellow or crack with age and provides a typical light transmittance of 93%.
- Zero uplight.
- Available in 5000K, 4000K, and 3000K color temperatures per ANSI C78.377. Also Available in Phosphor Converted Amber with Peak intensity at 610nm.
- Minimum CRI of 70.
- Integral louver (IL) and house-side shield (IH) options available for improved backlight control without sacrificing street side performance. See page 5 for more details.

Electrical

- High-performance programmable driver features over-voltage, under-voltage, short-circuit and over temperature protection. Custom lumen and wattage packages available.
- 0-10V dimming (10% - 100%) standard.
- Standard Universal Voltage (120-277 Vac) Input 50/60 Hz or optional High Voltage (347-480 Vac).
- L80 Calculated Life: >100k Hours (See Lumen Maintenance on Page 3)
- Total harmonic distortion: <20%
- Operating temperature: -40°C to +50°C (-40°F to +122°F). 42L lumen package rated to +40°C.
- Power factor: >.90
- Input power stays constant over life.
- Field replaceable 10kV surge protection device meets a minimum Category C Low operation (per ANSI/IEEE C62.41.2).
- High-efficacy LEDs mounted to metal-core circuit board to maximize heat dissipation
- Components are fully encased in potting material for moisture resistance. Driver complies with FCC standards. Driver and key electronic components can easily be accessed.

Controls

- Optional integral passive infrared Bluetooth™ motion and photocell sensor (see page 5 for more details). Fixtures operate independently and can be commissioned via iOS or Android configuration app.
- LSI's AirLink™ wireless control system

options reduce energy and maintenance costs while optimizing light quality 24/7. (see page 5 for more details).

Installation

- A single fastener secures the hinged door, underneath the housing and provides quick & easy access to the electrical compartment.
- Included terminal block accepts up to 12 ga. wire.
- Utilizes LSI's traditional 3" drill pattern B3 for easy fastening of LSI products.

Warranty

- LSI LED Fixtures carry a 5-year warranty.

Listings

- Listed to UL 1598 and UL 8750.
- Meets Buy American Act requirements.
- IDA compliant; with 3000K color temperature selection.
- Title 24 Compliant; see local ordinance for qualification information.
- Suitable for wet Locations.
- IP66 rated Luminaire per IEC 60598.
- 3G rated for ANSI C136.31 high vibration applications
- IP66 rated Luminaire per IEC 60598.
- 3G rated for ANSI C136.31 high vibration applications are qualified.

Specifications and dimensions subject to change without notice.





Slice Medium Outdoor LED Area Light

ORDERING GUIDE

[Back to Quick Links](#)

TYPICAL ORDER EXAMPLE: **SLM LED 36L SIL FTA UNV DIM 50 70CRI ALSCS04 BRZ IL**

Luminaire Prefix	Light Source	Lumen Package	Light Output	Distribution	Orientation ¹	Voltage	Driver
SLM Slice Medium	LED	9L - 9,000 lms 12L - 12,000 lms 18L - 18,000 lms 24L - 24,000 lms 30L - 30,000 lms 36L - 36,000 lms 42L - 42,000 lms Custom Lumen Packages ¹¹	SIL - Silicone	2 - Type 2 3 - Type 3 5W - Type 5 Wide FT - Forward Throw FTA - Forward Throw Automotive AM - Automotive Merchandise	(blank) - standard L - Optics rotated left 90 R - Optics rotated right 90	UNV - Universal Voltage (120-277V) HV - High Voltage (347-480V)	DIM - 0-10V Dimming (0-10%)

Color Temp	Color Rendering	Controls (Choose One)	Finish	Options
50 - 5,000 CCT 40 - 4,000 CCT 30 - 3,000 CCT ² AMB - Phosphor Converted Amber ^{2,3}	70CRI - 70 CRI	(Blank) - None Wireless Controls System ALSC - AirLink Synapse Control System ⁴ ALSCH - AirLink Synapse Control System Host / Satellite ^{4,5} ALSCS01 - AirLink Synapse Control System with 8-12' Motion Sensor ⁴ ALSCHS01 - AirLink Synapse Control System Host / Satellite with 8-12' Motion Sensor ^{4,5} ALSCS02 - AirLink Synapse Control System with 12-20' Motion Sensor ⁴ ALSCHS02 - AirLink Synapse Control System Host / Satellite with 12-20' Motion Sensor ^{4,5} ALSCS04 - AirLink Synapse Control System with 20-40' Motion Sensor ⁴ ALSCHS04 - AirLink Synapse Control System Host / Satellite with 20-40' Motion Sensor ^{4,5} ALBCS1 - AirLink Blue Wireless Motion & Photo Sensor Controller (8-24' mounting height) ⁴ ALBCS2 - AirLink Blue Wireless Motion & Photo Sensor Controller (25-40' mounting height) ⁴ Stand-Alone Controls EXT - 0-10V Dimming leads extended to housing exterior CR7P - 7 Pin Control Receptacle ANSI C136.41 ⁷ IMSBT1 - Integral Bluetooth™ Motion and Photocell Sensor max 8-24' mounting height ^{4,6} IMSBT2 - Integral Bluetooth Motion and Photocell Sensor max 25-40' mounting height ^{4,6} Button Type Photocells PCI120 - 120V PCI208-277 - 208 -277V PCI347 - 347V	BRZ - Bronze BLK - Black GPT - Graphite MSV - Metallic Silver WHT - White PLP - Platinum Plus SVG - Satin Verde Green	(Blank) - None IH - Integral Houseside Shield ¹ IL - Integral Louver (Sharp Spill Light Cutoff) ¹

FOOTNOTES:

- 1 - Not available on "Type 5W" distribution.
- 2 - Consult Factory for availability.
- 3 - Only available in 9L and 12L Lumen Packages
- 4 - Not available in HV.
- 5 - Consult Factory for Site Layout
- 6 - IMSBT is field configurable via the LSI app that can be downloaded from your smartphone's native app store.
- 7 - Control device or shorting cap must be ordered separately. See Accessory Ordering Information.
- 8 - Accessories are shipped separately and field installed.
- 9 - Factory installed CR7P option required. See Options.
- 10 - "CLR" denotes finish. See Finish options.
- 11 - Custom lumen and wattage packages available consult factory. Values are within industry standard tolerances but not DLC listed.





Slice Medium Outdoor LED Area Light

ACCESSORY ORDERING INFORMATION⁸

Controls Accessories	
Description	Order Number
Twist Lock Photocell (120V) for use with CR7P	122514
Twist Lock Photocell (208-277) for use with CR7P	122515
Twist Lock Photocell (347V) for use with CR7P	122516
Twist Lock Photocell (480V) for use with CR7P	1225180
AirLink 5 Pin Twist Lock Controller	661409
AirLink 5 Pin Twist Lock Controller	661410
Pole-Mounted Occupancy Sensor (24V)	663284CLR
Shorting Cap for use with CR7P	149328

Fusing Accessories	
Description	Order Number
Single Fusing (120V)	FK120
Single Fusing (120V)	FK277
Double Fusing (208V, 240V)	DFK240
Double Fusing (480V)	DFK480
Double Fusing (347V)	DFK347

Mounting Accessories	
Description	Order Number
Round Pole Adapter (3" Round/Tapered Poles)	408273CLR
Round Pole Adapter (4" Round Poles)	379967CLR
Round Pole Adapter (5" Round Poles)	379968CLR
Universal Mounting Bracket	684616CLR
Adjustable Slip Fitter (2" - 2 3/8" Tenon)	688138CLR
Quick Mount Pole Bracket (Square Pole)	687073CLR
Quick Mount Pole Bracket (4-5" Round Pole)	689903CLR
15 Tilt Quick Mount Pole Bracket (Square Pole)	688003CLR
15 Tilt Quick Mount Pole Bracket (4-5" Round Pole)	689905CLR
Wall Mount Bracket	382132CLR
Wood Pole Bracket (6" Minimum Pole Diameter)	751219CLR

Miscellaneous Accessories	
Description	Order Number
Integral Louver/Shield	684812
Integral Houseside Shield	743414
10' Linear Bird Spike Kit (6' Recommended per Luminaire)	736795

OPTICS ROTATION

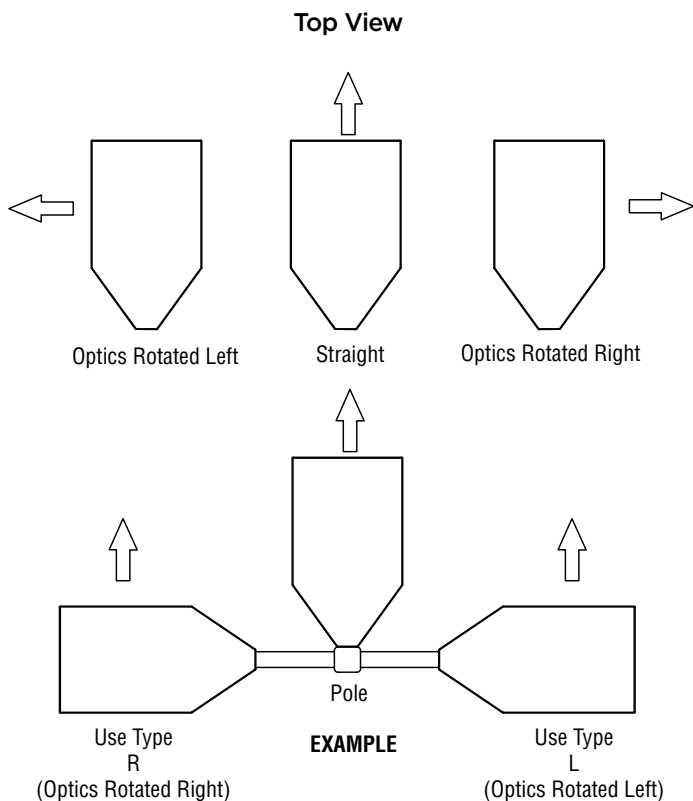

ACCESSORIES/OPTIONS

Integral Louver (IL) and House-Side Shield (IH)

Accessory louver and shield available for improved backlight control without sacrificing street side performance. LSI's Integral Louver (L) and Integral House-Side Shield (IH) options deliver backlight control that significantly reduces spill light behind the poles for applications with pole locations close to adjacent properties. The design maximizes forward reflected light while reducing glare, maintaining the optical distribution selected, and most importantly eliminating light trespass. Both options rotate with the optical distribution.

Luminaire Shown with Integral Louver (IL)



Luminaire Shown with IMSBT Option



7 Pin Photoelectric Control

7-pin ANSI C136.41-2013 control receptacle option available for twist lock photocontrols or wireless control modules. Control accessories sold separately. Dimming leads from the receptacle will be connected to the driver dimming leads (Consult factory for alternate wiring).

Fixture Shown with CR7P

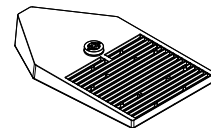



Slice Medium Outdoor LED Area Light

PERFORMANCE

[Back to Quick Links](#)

Delivered Lumens*												
Lumen Package	Distribution	CRI	3000K CCT			4000K CCT			5000K CCT			Wattage
			Delivered Lumens	Efficacy	BUG Rating	Delivered Lumens	Efficacy	BUG Rating	Delivered Lumens	Efficacy	BUG Rating	
9L	2	70	8956	131	B2-U0-G2	9427	138	B2-U0-G2	9838	144	B2-U0-G2	68
	3		9088	133	B2-U0-G2	9566	140	B2-U0-G2	9983	146	B2-U0-G2	
	5W		8431	123	B3-U0-G2	8875	130	B3-U0-G2	8262	135	B3-U0-G2	
	FT		9046	133	B2-U0-G2	9522	140	B2-U0-G2	9937	146	B2-U0-G2	
	FTA		8993	131	B2-U0-G2	9466	138	B2-U0-G2	9879	144	B2-U0-G2	
	AM		8953	132	B2-U0-G1	9817	144	B2-U0-G2	10210	150	B2-U0-G2	
12L	2	70	11842	127	B3-U0-G2	12465	134	B3-U0-G2	13009	140	B3-U0-G2	93
	3		12017	129	B2-U0-G2	12649	136	B2-U0-G2	13200	142	B2-U0-G2	
	5W		11149	120	B4-U0-G2	11735	126	B4-U0-G2	12247	132	B4-U0-G2	
	FT		11962	128	B2-U0-G2	12591	135	B2-U0-G2	13140	141	B2-U0-G3	
	FTA		11891	128	B3-U0-G3	12517	134	B3-U0-G3	13062	140	B3-U0-G3	
	AM		11997	129	B2-U0-G2	13155	141	B3-U0-G2	13681	147	B3-U0-G2	
18L	2	70	17722	119	B3-U0-G3	18655	126	B3-U0-G3	19468	131	B3-U0-G3	149
	3		17984	121	B2-U0-G3	18930	127	B3-U0-G3	19755	133	B3-U0-G3	
	5W		16685	112	B4-U0-G2	17563	118	B4-U0-G2	18328	123	B4-U0-G2	
	FT		17901	121	B3-U0-G3	18843	127	B3-U0-G3	19664	132	B3-U0-G4	
	FTA		17796	120	B3-U0-G3	18732	126	B3-U0-G3	19549	132	B3-U0-G3	
	AM		17906	121	B3-U0-G2	19634	133	B3-U0-G2	20419	148	B3-U0-G2	
24L	2	70	24122	128	B4-U0-G3	24851	132	B4-U0-G3	25119	133	B4-U0-G3	189
	3		24945	132	B3-U0-G3	25699	136	B3-U0-G4	25976	138	B3-U0-G4	
	5W		22673	122	B5-U0-G3	23667	125	B5-U0-G3	23823	127	B5-U0-G3	
	FT		24276	129	B3-U0-G4	25010	132	B3-U0-G4	25280	134	B3-U0-G4	
	FTA		24715	131	B3-U0-G3	25462	135	B3-U0-G3	25737	136	B3-U0-G3	
	AM		24056	127	B3-U0-G2	25729	136	B3-U0-G3	26243	139	B3-U0-G3	
30L	2	70	30286	122	B4-U0-G3	31201	126	B4-U0-G3	31538	127	B4-U0-G3	249
	3		31319	126	B3-U0-G4	32266	130	B3-U0-G4	32614	131	B3-U0-G4	
	5W		28843	116	B5-U0-G3	29715	120	B5-U0-G3	30036	121	B5-U0-G4	
	FT		30479	123	B3-U0-G4	31401	126	B3-U0-G4	31740	128	B3-U0-G5	
	FTA		31030	125	B3-U0-G3	31969	129	B4-U0-G3	32314	130	B4-U0-G3	
	AM		30471	122	B3-U0-G3	32590	131	B3-U0-G3	33242	134	B3-U0-G3	
36L	2	70	36082	114	B4-U0-G4	37173	117	B4-U0-G4	37574	118	B4-U0-G4	318
	3		37313	117	B3-U0-G4	38442	121	B3-U0-G4	38857	122	B4-U0-G4	
	5W		34363	108	B5-U0-G4	35402	111	B5-U0-G4	35784	113	B5-U0-G4	
	FT		36313	114	B3-U0-G5	37411	118	B4-U0-G5	37815	119	B4-U0-G5	
	FTA		36969	116	B4-U0-G4	38087	120	B4-U0-G4	38498	121	B4-U0-G4	
	AM		36718	115	B3-U0-G3	39270	123	B4-U0-G3	40056	126	B4-U0-G3	
42L	2	70	41060	104	B5-U0-G4	42301	108	B5-U0-G4	42758	109	B5-U0-G4	393
	3		42461	108	B4-U0-G5	43745	111	B4-U0-G5	44217	112	B4-U0-G5	
	5W		39104	99	B5-U0-G4	40286	102	B5-U0-G4	40721	104	B5-U0-G4	
	FT		41323	105	B4-U0-G5	42572	108	B4-U0-G5	43032	109	B4-U0-G5	
	FTA		42069	107	B4-U0-G4	43341	110	B4-U0-G4	43809	111	B4-U0-G4	
	AM		42205	107	B4-U0-G3	45138	114	B4-U0-G3	46041	116	B4-U0-G3	





Slice Medium Outdoor LED Area Light

PERFORMANCE (CONT.)

ELECTRICAL DATA (AMPS)*							
Lumens	Watts	120V	208V	240V	277V	347V	480V
9L	68.2	0.6	0.3	0.3	0.2	0.2	0.1
12L	93.1	0.8	0.4	0.4	0.3	0.3	0.2
18L	148.5	1.2	0.7	0.6	0.5	0.4	0.3
24L	188.8	1.6	0.9	0.8	0.7	0.5	0.4
30L	248.6	2.1	1.2	1.0	0.9	0.7	0.5
36L	317.8	2.6	1.5	1.3	1.1	0.9	0.7
42L	393.4	3.3	1.9	1.6	1.4	1.1	0.8

*Electrical data at 25°C (77°F). Actual wattage may differ by +/-10%

FOOTNOTES:

- Lumen maintenance values at 25C are calculated per TM-21 based on LM-80 data and in-situ testing.
- In accordance with IESNA TM-21-11, Projected Values represent interpolated value based on time durations that are within six times the IESNA LM-80-08 total test duration for the device under testing.
- In accordance with IESNA TM-21-11, Calculated Values represent time durations that exceed six times the IESNA LM-80-08 total test duration for the device under testing.

RECOMMENDED LUMEN MAINTENANCE ¹ (9-18L)					
Ambient	Initial ²	25h ²	50h ²	75h ²	100h ²
0 C	100%	97%	94%	90%	87%
10 C	100%	97%	94%	90%	87%
20 C	100%	97%	94%	90%	87%
25 C	100%	97%	93%	90%	86%
30 C	100%	97%	93%	89%	86%
40 C	100%	97%	92%	88%	84%
50 C	100%	96%	91%	87%	83%

RECOMMENDED LUMEN MAINTENANCE ¹ (42L)					
Ambient	Initial ²	25h ²	50h ²	75h ²	100h ²
0 C - 40C	100%	100%	97%	94%	92%

PHOTOMETRICS

[Back to Quick Links](#)

Luminaire photometry has been conducted by a NVLAP accredited testing laboratory in accordance with IESNA LM-79-08. As specified by IESNA LM-79-08 the entire luminaire is tested as the source resulting in a luminaire efficiency of 100%.

See <http://www.lsi-industries.com/products/led-lighting-solutions.aspx> for detailed photometric data.

SLM-LED-30L-SIL-2-40-70CRI

LUMINAIRE DATA

Type 2 Distribution	
Description	4000 Kelvin, 70 CRI
Delivered Lumens	31,201
Watts	248.6
Efficacy	126
IES Type	Type II - Short
BUG Rating	B4-U0-G3

Zonal Lumen Summary

Zone	Lumens	%Luminaire
Low (0-30)°	4375	14%
Medium (30-60)°	18726	60%
High (60-80)°	7949	25%
Very High (80-90)°	152	0%
Uplight (90-180)°	0	0%
Total Flux	31201	100%

ISO FOOTCANDLE

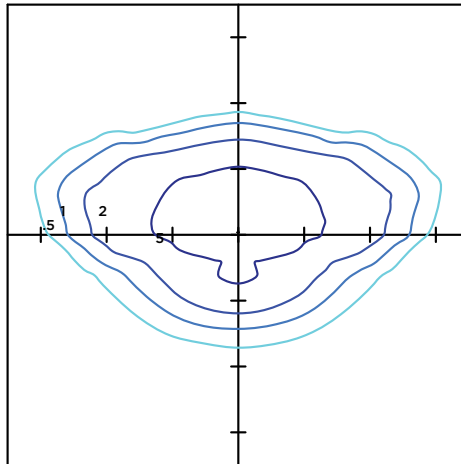

25' Mounting Height/ 25' Grid Spacing

■ 5 FC ■ 2 FC ■ 1 FC ■ 0.5 FC

POLAR CURVE

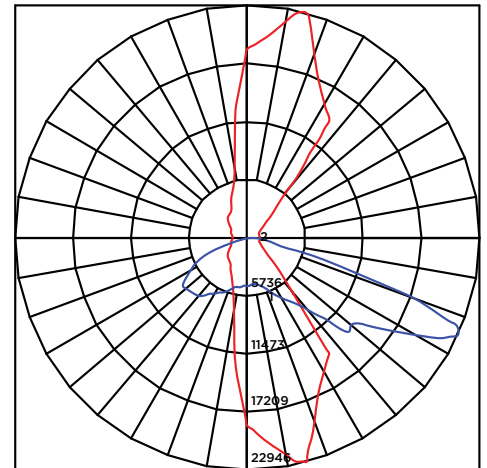



Slice Medium Outdoor LED Area Light

PHOTOMETRICS (CONT.)

SLM-LED-30L-SIL-3-40-70CRI

LUMINAIRE DATA

Type 3 Distribution	
Description	4000 Kelvin, 70 CRI
Delivered Lumens	32,266
Watts	248.6
Efficacy	130
IES Type	Type III - Short
BUG Rating	B3-U0-G4

Zonal Lumen Summary

Zone	Lumens	%Luminaire
Low (0-30)°	3497	11%
Medium (30-60)°	16867	52%
High (60-80)°	11653	36%
Very High (80-90)°	248	1%
Uplight (90-180)°	0	0%
Total Flux	32266	100%

ISO FOOTCANDLE

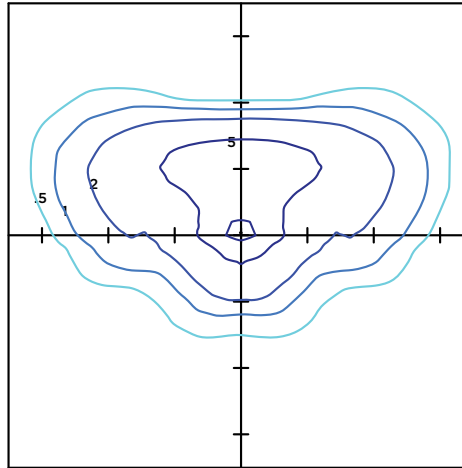

POLAR CURVE

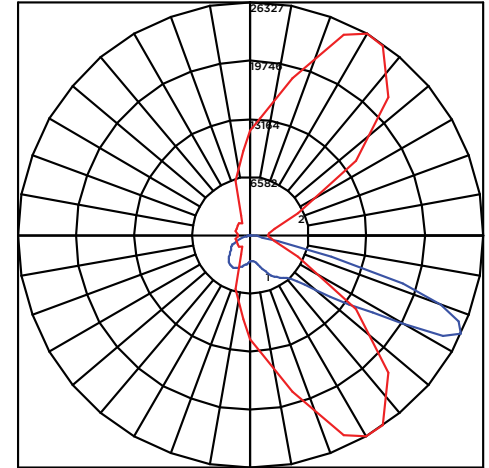

25' Mounting Height/ 25' Grid Spacing

■ 5 FC ■ 2 FC ■ 1 FC ■ 0.5 FC

SLM-LED-30L-SIL-FT-40-70CRI

LUMINAIRE DATA

Type FT Distribution	
Description	4000 Kelvin, 70 CRI
Delivered Lumens	31,401
Watts	248.6
Efficacy	126
IES Type	Type IV - Short
BUG Rating	B3-U0-G4

Zonal Lumen Summary

Zone	Lumens	%Luminaire
Low (0-30)°	3659	12%
Medium (30-60)°	14488	46%
High (60-80)°	12808	41%
Very High (80-90)°	447	1%
Uplight (90-180)°	0	0%
Total Flux	31402	100%

ISO FOOTCANDLE

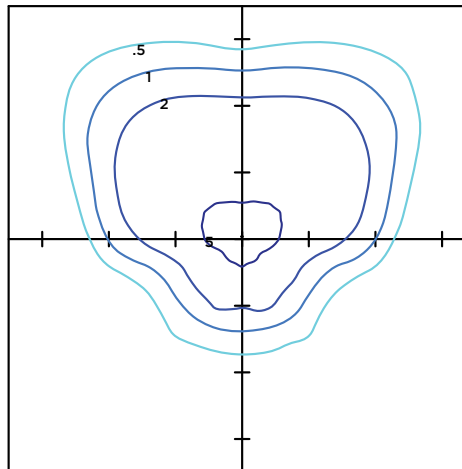

POLAR CURVE

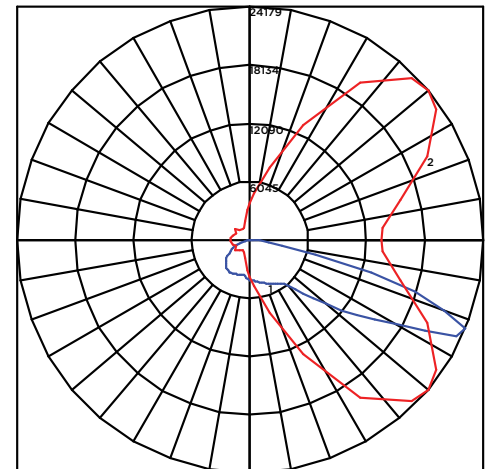

25' Mounting Height/ 25' Grid Spacing

■ 5 FC ■ 2 FC ■ 1 FC ■ 0.5 FC





Slice Medium Outdoor LED Area Light

PHOTOMETRICS (CONT.)

SLM-LED-30L-SIL-5W-40-70CRI

LUMINAIRE DATA

Type 5W Distribution

Description	4000 Kelvin, 70 CRI
Delivered Lumens	29,715
Watts	248.6
Efficacy	120
IES Type	Type IV - Short
BUG Rating	B5-U0-G3

Zonal Lumen Summary

Zone	Lumens	%Luminaire
Low (0-30)°	2930	10%
Medium (30-60)°	11709	39%
High (60-80)°	14881	50%
Very High (80-90)°	194	1%
Uplight (90-180)°	0	0%
Total Flux	29715	100%

ISO FOOTCANDLE

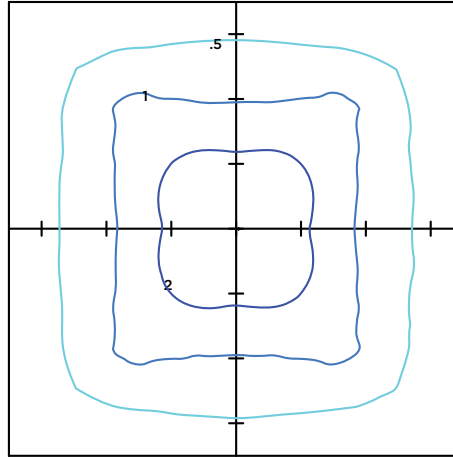

POLAR CURVE

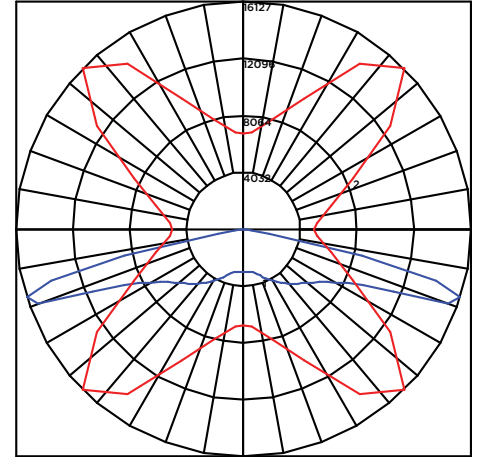

25' Mounting Height/ 25' Grid Spacing

■ 5 FC ■ 2 FC ■ 1 FC ■ 0.5 FC

SLM-LED-30L-SIL-FTA-40-70CRI

LUMINAIRE DATA

Type FTA Distribution

Description	4000 Kelvin, 70 CRI
Delivered Lumens	31,970
Watts	248.6
Efficacy	129
IES Type	Type II - Short
BUG Rating	B4-U0-G3

Zonal Lumen Summary

Zone	Lumens	%Luminaire
Low (0-30)°	5840	18%
Medium (30-60)°	19571	61%
High (60-80)°	6265	20%
Very High (80-90)°	294	1%
Uplight (90-180)°	0	0%
Total Flux	31970	100%

ISO FOOTCANDLE

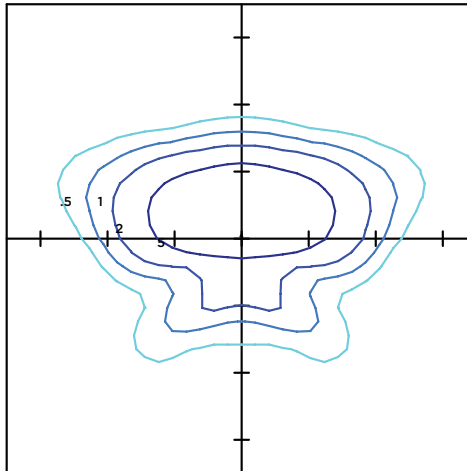

POLAR CURVE

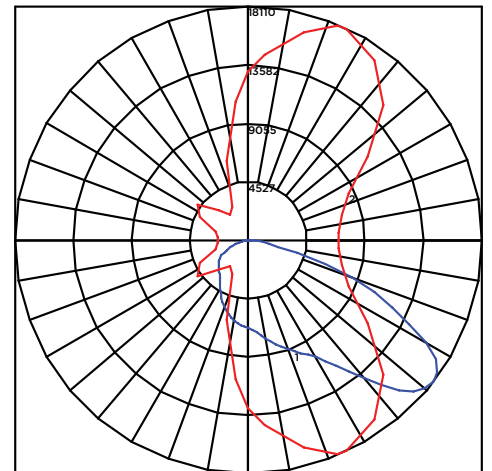

25' Mounting Height/ 25' Grid Spacing

■ 5 FC ■ 2 FC ■ 1 FC ■ 0.5 FC





Slice Medium Outdoor LED Area Light

PHOTOMETRICS (CONT.)

SLM-LED-30L-SIL-AM-40-70CRI

LUMINAIRE DATA

Type AM Distribution	
Description	4000 Kelvin, 70 CRI
Delivered Lumens	32,590
Watts	249
Efficacy	131
IES Type	Type III - Very Short
BUG Rating	B3-U0-G3

Zonal Lumen Summary

Zone	Lumens	%Luminaire
Low (0-30)°	5652	17%
Medium (30-60)°	20618	63%
High (60-80)°	5956	18%
Very High (80-90)°	364	1%
Uplight (90-180)°	0	0%
Total Flux	32590	100%

ISO FOOTCANDLE

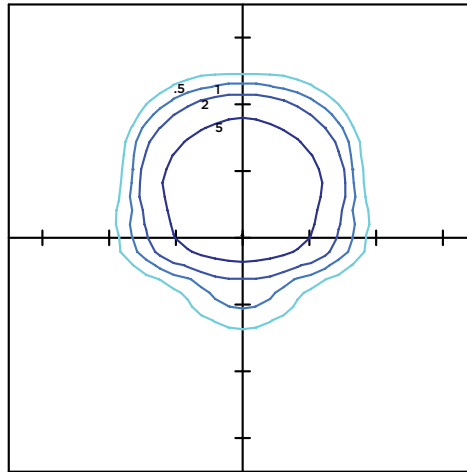

POLAR CURVE

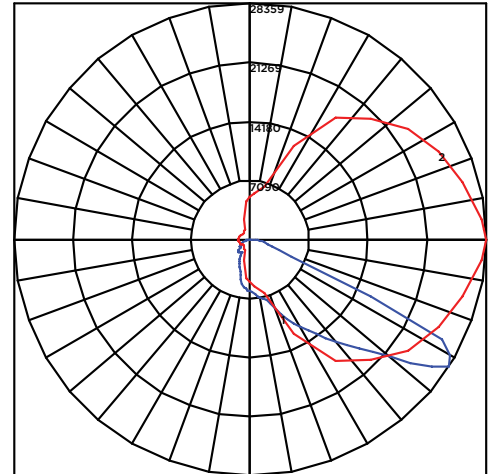

25' Mounting Height/ 25' Grid Spacing
 ■ 5 FC ■ 2 FC ■ 1 FC ■ 0.5 FC

PRODUCT DIMENSIONS

[Back to Quick Links](#)

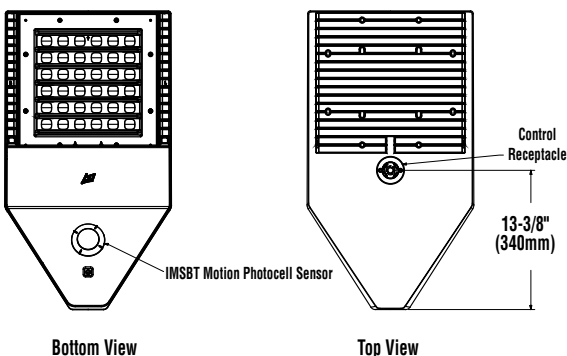
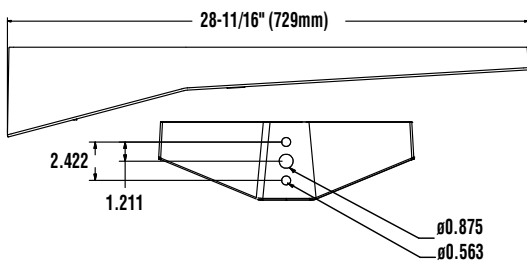
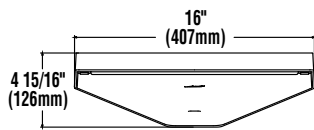

LUMINAIRE EPA CHART - SLM									
Tilt Degree		0°	30°	45°	Tilt Degree	0°	30°	45°	
■	Single	0.5	2.1	2.6	■	T90°	1.2	2.9	3.6
■	D180°	1.1	2.1	2.6	■	TN120°	1.3	4.4	5.4
■	D90°	0.9	2.5	3.1	■	Q90°	1.2	2.9	3.6





CONTROLS

AirLink Wireless Lighting Controller

The AirLink integrated controller is a California Title 24 compliant lighting controller that provides real-time light monitoring and control with utility-grade power monitoring. It includes a 24V sensor input and power supply to connect a sensor into the outdoor AirLink wireless lighting system.

The wireless integrated controller is compatible with this fixture.

Click the link below to learn more details about AirLink.

<https://www.lsi-industries.com/documents/datasheets/airlink-outdoor-specsheet.pdf>

Integral Bluetooth™ Motion and Photocell Sensor (IMSBT)

Slim low profile sensor provides multi-level control based on motion and/or daylight. Sensor controls 0-10 VDC LED drivers and is rated for cold and wet locations (-30° C to 70° C). Two unique PIR lenses are available and used based on fixture mounting height. All control parameters are adjustable via an iOS or Android App capable of storing and transmitting sensor profiles.

Click the link below to learn more details about IMSBT.

<https://www.lsi-industries.com/documents/datasheets/imsbt-specsheet.pdf>

AirLink Blue

Wireless Bluetooth Mesh Outdoor Lighting Control System that provides energy savings, code compliance and enhanced safety/security for parking lots and parking garages. Three key components; Bluetooth wireless radio/sensor controller, Time Keeper and an iOS App. Capable of grouping multiple fixtures and sensors as well as scheduling time-based events by zone. Radio/Sensor Controller is factory integrated into Area/Site, Wall Mounted, Parking Garage and Canopy luminaires.

Click the link below to learn more details about AirLink Blue.

<https://www.lsi-airlink.com/airlink-blue/>

POLES & BRACKETS

LSI offers a full line of poles and mounting accessories to complete your lighting assembly. Aluminum and steel in both square and round shafts. In addition, LSI offers round tapered, fluted and hinge based poles. Designed and engineered for durability and protected with our oven baked DuraGrip Protection System. Also available with our DuraGrip+ Protection system for unmatched corrosion resistance and an extended warranty. American made in our Ohio facility with industry leading lead times.

Click the link below to learn more details about poles & brackets.

<https://www.lsi-industries.com/products/poles-and-brackets-area-street.aspx>



BKA UMB CLR

The 3G rated UMB allows for seamless integration of LSI luminaires onto existing/ retrofit or new construction poles. The UMB was designed for square or round (tapered or straight) poles with two mounting hole spacings between 3.5" - 5".



BKA ASF CLR

The adjustable Slip Fitter is a 3G rated rugged die cast aluminum adapter to mount LSI luminaires onto a 2" iron pipe, 2 3/8 OD tenon. The Adjustable Slip Fitter can be rotated 180° allowing for tilting LSI luminaires up to 45° and 90° when using a vertical tenon.



BKS PQM15 CLR

The Pole Quick Mount Bracket allows for preset 15° uptilt of LSI luminaires for greater throw of light and increased vertical illumination as well as fast installation onto poles with LSI's 3" or 5" bolt pattern.



BKS PQMH CLR

The Pole Quick Mount Bracket allows for lightning fast installation of LSI luminaires onto existing and new construction poles with LSI's B3 or B5 standard pole bolt patterns.



Square Pole
14'-39'



Round Pole
10'-30'

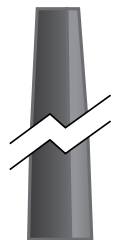

Tapered Pole
20'-39'



STEEL SQUARE POLES

DIMENSIONS

SQN –
N= 2-3/8" (60mm) O.D. x 4-3/4" (121mm) Tenon

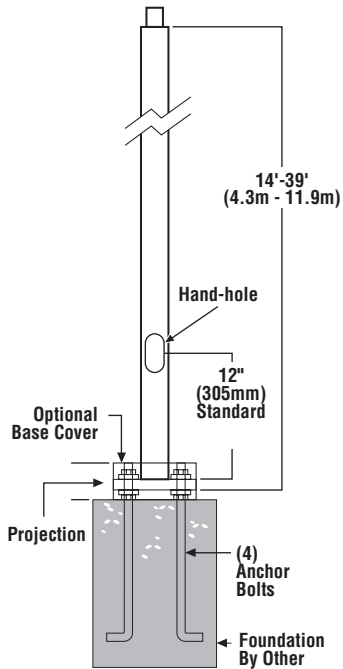

SQB3, SOB5 –
Bolt-On Mount
2-Bolt Pattern

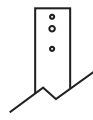

SQ1 –
No Mounting Holes



SF –
Single Flood
Pole Preparation



POLE SHAFT - Pole shaft is electro-welded ASTM-A500 Grade C steel tubing with a minimum yield strength of 50,000 psi. On Tenon Mount steel poles, tenon is 2-3/8" O.D. high-strength pipe. Tenon is 4-3/4" in length. Straight poles are 4", 5", and 6" square.

HAND-HOLE - Standard hand-hole location is 12" above pole base. Poles 22' and above have a 3" x 6" reinforced hand-hole. Shorter poles have a 2" x 4" non-reinforced hand-hole.

BASE - Pole base is ASTM-A36 hot-rolled steel plate with a minimum yield strength of 36,000 psi. Two-piece square base cover is optional.

ANCHOR BOLTS - Poles are furnished with anchor bolts featuring zinc-plated double nuts and washers. Galvanized anchor bolts are optional. Anchor bolts conform to ASTM F 1554-07a Grade 55 with a minimum yield strength of 55,000 psi.

GROUND LUG - Ground lug is standard.

DUPLEX RECEPTACLE - Weatherproof duplex receptacle is optional.

GROUND FAULT CIRCUIT INTERRUPTER - Self-testing ground fault circuit interrupter is optional.

FINISHES - Each pole is finished with DuraGrip®, LSI's baked-on polyester-powder finishing process which electrostatically applies and fuses a polyester powder to the pole. Provides an extremely smooth and uniform finish to withstand extreme weather changes without cracking or peeling, and features a five-year limited warranty. Optional DuraGrip® Plus features the added protection of a 3.0 to 5.0 mil thickness of polyester-powder finish plus an inner coating, as well as a seven-year limited warranty.

DETERMINING THE LUMINAIRE/POLE COMBINATION FOR YOUR APPLICATION:

- Select luminaire from luminaire ordering information
- Select bracket configuration if required
- Determine EPA value from luminaire/bracket EPA chart
- Select pole height
- Select MPH to match wind speed in the application area (See windspeed maps).
- Confirm pole EPA equal to or exceeding value from note above
- Consult factory for special wind load requirements and banner brackets

DRILLING LOCATIONS

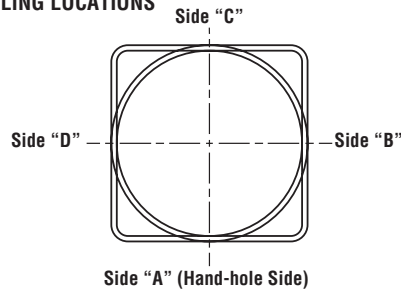

Sides	A	B	C	D
Hand-hole	X			
Single	X			
D180°		X		X
D90°	X			X
T90°	X	X		X
TN120°*	X			
Q90°	X	X	X	X
Single FBO	X			
Double FBO		X		X

*Other two locations will be 120° to the left and right of Side A.

Note: Standard SF and DF pole preparations are located 3/4 of the height of the pole from the base, unless otherwise specified.

SHIPPING WEIGHTS - Steel Square Poles

4" (102mm) sq. 11 Ga. is approximately	7.50 lbs./ft.
4" (102mm) sq. 07 Ga. is approximately	10.00 lbs./ft.
5" (127mm) sq. 11 Ga. is approximately	9.00 lbs./ft.
5" (127mm) sq. 07 Ga. is approximately	12.50 lbs./ft.
6" (152mm) sq. 07 Ga. is approximately	15.40 lbs./ft.
Anchor Bolts (3/4" x 30") (19mm x 762mm)	15 lbs. (7kg)/set
Anchor Bolts (1" x 36") (25mm x 914mm)	30 lbs. (14kg)/set

ARRA
Funding Compliant



Project Name **Maverik** Fixture Type **T14 Pole**
Catalog # **4SQ B3 S11G 17'-6" S BRZ**

11/27/17
© 2017
LSI INDUSTRIES INC.

STEEL SQUARE POLES

POLE ORDERING INFORMATION





TYPICAL ORDER EXAMPLE: **5SQB5 S07G 24 S PLP SF DGP**

Pole Series	Material	Height ²	Mounting Configuration	Pole Finish	Options
Bolt-on Arm Mount - See pole selection guide for patterns and fixture matches. 4SQB3 - 3" Reduced drilling pattern 5SQB3 - 3" Reduced drilling pattern 4SQB5 - 5" Traditional drilling pattern 5SQB5 - 5" Traditional drilling pattern 6SQB5 - 5" Traditional drilling pattern	S11G - 11 Ga. Steel S07G - 07 Ga. Steel	14' 16' 18' 20' 22' 24' 26' 28' 30' 35' 39'	S - Single/Parallel D180° - Double D90° - Double DN90° - Double T90° - Triple TN120° - Triple Q90° - Quad QN90° - Quad N - Tenon Mount (Standard tenon size is 2-3/8" O.D.)	BRZ - Bronze BLK - Black PLP - Platinum Plus WHT - White SVG - Satin Verde Green GPT - Graphite MSV - Metallic Silver	GA - Galvanized Anchor Bolts SF - Single Flood ³ DF - Double Flood ³ DGP - DuraGrip® Plus LAB - Less Anchor Bolts OSXX - Pole preparation for PMOS Occupancy Sensor ⁴
Tenon Mount - See pole selection guide for tenon and fixture/bracket matches. 4SQN 5SQN 6SQN	<div style="border: 1px solid black; padding: 5px; text-align: center;"> Consult Pole Selection Chart on opposite page </div>			<div style="border: 1px solid black; padding: 5px;"> Standard SF and DF pole preparations are located 3/4 of the height of the pole from the base, unless otherwise specified. </div>	
No Mounting Holes - Use with: <ul style="list-style-type: none"> BKA 4ISF & BKA 5ISF BKA X4ISF & BKA X5ISF 					
Internal Slip-fitter¹ 4SQI 5SQI					

ACCESSORY ORDERING INFORMATION (Accessories are field installed)		
Description	Order Number	Order Number
4BC - 4" Square Base Cover	122559CLR	Vibration Damper - 4" Square Pole (bolt-on mount only) 172539
5BC - 5" Square Base Cover	122561CLR	Vibration Damper - 5" Square Pole (bolt-on mount only) 172538
6BC - 6" Square Base Cover	122563CLR	Vibration Damper - 6" Square Pole (bolt-on mount only) 178361
ER2 - Weatherproof Duplex Receptacle	122566CLR	PMOS120 - 120V Occupancy Sensor 518030CLR ⁵
GFI - Ground Fault Circuit Interrupter	122567CLR	PMOS208/240 - 208, 240V Occupancy Sensor 534239CLR ⁵
MHP - Mounting Hole Plugs (3 plugs)-for use with 5" traditional drill pattern	132336	PMOS277 - 277V Occupancy Sensor 518029CLR ⁵
MHD - Mounting Hole Weatherproof Decal-for use with 3" reduced drill pattern	340120	PMOS480 - 480V Occupancy Sensor 534240CLR ⁵

FOOTNOTES:

- See Area Lighting Brackets 3" Reduced Drill Pattern and Area Lighting Brackets - Bolt-on 5" Traditional Drill Pattern spec sheets for Internal Slip-fitter brackets.
- Pole heights will have +/- 1/2" tolerance.
- See Flood Lighting Brackets section for choice of FBO brackets.
- Order PMOS separately. Change "XX" to indicate height and side of pole location for pole preparation. EX: OS18A indicates preparation is to be 18ft. up from pole base on side A. Optimal distance from ground to sensor is 20ft.
- OSXX option required. Not for use with Metal Halide fixtures

	4" (102mm) square 10-1/8" (257mm) sq.	5" (127mm) square 10-1/8" (257mm) sq.	5" (127mm) square 10-1/8" (257mm) sq.	6" (152mm) square 12" (305mm) sq.
				
	11" (279mm) Dia. Bolt Circle	11" (279mm) Dia. Bolt Circle	11" (279mm) Dia. Bolt Circle	12" (305mm) Dia. Bolt Circle
	B	C	D	J
Bolt Circle	8"-11" (203mm-279mm)	9"-11" (229mm-279mm)	9"-11" (229mm-279mm)	12" (305mm)
Anchor Bolt Size	3/4" x 30" (19mm x 762mm)	3/4" x 30" (19mm x 762mm)	1" x 36" (25mm x 914mm)	1" x 36" (25mm x 914mm)
Anchor Bolt Projection	3-1/4" (83mm)	3-1/4" (83mm)	4" (102mm)	4" (102mm)
Base Plate Opening for Wireway Entry	3-5/8" (92mm)	4-3/4" (121mm)	4-5/8" (117mm)	5-5/8" (143mm)
Base Plate Dimensions	10-1/8" sq. x 3/4" thk. (257mm x 19mm)	10-1/8" sq. x 3/4" thk. (257mm x 19mm)	10-1/8" sq. x 1" thk. (257mm x 25mm)	12" sq. x 1-1/8" thk. (305mm x 29mm)

Note: Base plate illustrations may change without notice. Do not use for setting anchor bolts. Consult factory for the base plate templates.



Project Name **Maverik** Fixture Type **T14 Pole**
 Catalog # **4SQ B3 S11G 17'-6" S BRZ**

11/27/17
 © 2017
 LSI INDUSTRIES INC.

STEEL SQUARE POLES

Use ONLY with "Wind Speed Map for ASCE7-05"

STEEL SQUARE POLES - ASCE7-05								
POLE	90 MPH	100 MPH	110 MPH	120 MPH	130 MPH	140 MPH	150 MPH	Bolt Circle
4" 11GA 14'	18.7	14.5	11.5	9.1	7.3	5.9	4.6	B
4" 11GA 16'	15.1	11.5	8.9	6.9	5.4	4.1	3.1	B
4" 11GA 18'	12.2	9.1	6.8	5.1	3.7	2.7	1.8	B
4" 11GA 20'	9.5	6.9	4.9	3.4	2.2	1.3	0.5	B
4" 11GA 22'	9.6	7.0	4.7	3.0	1.5	0.5	0.0	B
4" 11GA 24'	7.7	5.3	3.4	1.8	0.4	0.0	0.0	B
4" 11GA 26'	5.7	3.3	1.9	0.6	0.0	0.0	0.0	B
4" 7GA 20'	14.8	11.2	8.4	6.4	4.8	3.5	2.4	B
4" 7GA 22'	14.9	11.0	8.2	6.0	4.4	3.0	1.9	B
4" 7GA 24'	12.4	8.8	6.3	4.4	2.9	1.7	0.8	B
4" 7GA 26'	10.1	6.9	4.6	2.9	1.6	0.5	0.0	B
5" 11GA 16'	29.4	23.0	18.2	14.6	11.8	9.6	7.8	C
5" 11GA 18'	24.2	19.7	14.5	11.4	9.0	7.1	5.5	C
5" 11GA 20'	20.0	14.9	11.5	8.8	6.6	4.9	3.6	C
5" 11GA 22'	20.8	15.5	11.7	8.7	6.4	4.6	3.2	C
5" 11GA 24'	17.2	12.8	9.3	6.6	4.5	3.0	1.6	C
5" 11GA 26'	14.8	10.2	7.1	4.7	2.8	1.4	0.2	C
5" 7GA 20'	30.5	23.7	18.6	14.7	11.7	9.3	7.4	D
5" 7GA 22'	41.2	32.0	25.4	20.3	16.2	13.2	10.5	D
5" 7GA 24'	36.0	27.9	21.8	17.1	13.5	10.7	8.4	D
5" 7GA 26'	32.0	23.8	18.3	14.1	10.9	8.3	6.2	D
5" 7GA 30'	24.1	17.5	13.0	9.4	6.7	4.5	2.8	D
6" 7GA 24'	51.0	39.7	31.3	24.9	19.9	16.0	12.8	J
6" 7GA 26'	44.5	34.2	26.7	20.9	16.4	12.9	10.0	J
6" 7GA 30'	34.3	25.8	19.4	14.6	10.8	7.9	5.4	J
6" 7GA 35'	24.8	17.8	12.5	8.5	5.4	2.9	0.9	J
6" 7GA 39'	18.6	12.4	7.8	4.4	1.6	0.0	0.0	J

All LSI Industries' poles are guaranteed to meet the EPA requirements listed. LSI Industries is not responsible if a pole order has a lower EPA rating than the indicated wind-loading zone where the pole will be located.

CAUTION: This guarantee does not apply if the pole/bracket/fixture combination is used to support any other items such as flags, pennants, or signs, which would add stress to the pole. LSI Industries cannot accept responsibility for harm or damage caused in these situations.



STEEL SQUARE POLES

Use ONLY with "Wind Speed Map for ASCE7-10

STEEL SQUARE POLES - ASCE7-10										
POLE	110 MPH	115 MPH	120 MPH	130 MPH	140 MPH	150 MPH	160 MPH	170 MPH	180 MPH	Bolt Circle
4" 11GA 14'	12.5	11.3	10.2	8.5	6.8	5.8	4.9	4.1	3.6	B
4" 11GA 16'	9.8	8.6	7.9	6.5	5.4	4.4	3.5	2.9	2.2	B
4" 11GA 18'	8.1	7.4	6.7	5.4	4.2	3.4	2.8	2.2	1.7	B
4" 11GA 20'	7.1	6.3	5.6	4.4	3.4	2.7	2.1	1.6	1.1	B
4" 11GA 22'	9.9	8.8	7.9	6.3	5.1	4.0	3.1	2.5	2.0	B
4" 11GA 24'	8.6	7.5	6.8	5.3	4.2	3.3	2.5	1.9	1.3	B
4" 11GA 26'	6.8	6.1	5.5	4.2	3.2	2.3	1.6	1.0	0.6	B
4" 7GA 20'	10.7	9.7	8.7	7.0	5.7	4.6	3.8	3.1	2.5	B
4" 7GA 22'	11.3	10.2	9.1	7.3	5.8	4.7	3.5	2.7	2.1	B
4" 7GA 24'	9.8	8.9	7.8	6.0	4.5	3.5	2.8	2.1	1.6	B
4" 7GA 26'	7.9	7.1	6.1	4.7	3.6	2.8	1.9	1.2	0.7	B
5" 11GA 16'	18.1	16.4	14.8	12.3	10.3	8.7	7.3	6.3	5.3	C
5" 11GA 18'	15.7	14.2	12.8	10.5	8.7	7.3	6.1	5.1	4.3	C
5" 11GA 20'	13.5	12.3	11.1	9.0	7.4	6.0	4.8	3.8	3.1	C
5" 11GA 22'	15.8	14.3	12.6	10.2	8.3	6.5	5.4	4.2	3.5	C
5" 11GA 24'	13.8	12.5	10.8	8.6	6.7	5.2	3.9	3.0	2.1	C
5" 11GA 26'	11.3	10.3	8.9	6.9	5.3	4.0	3.0	2.2	1.5	C
5" 7GA 20'	20.7	18.8	17.0	14.0	11.7	9.8	7.9	7.0	5.9	D
5" 7GA 22'	25.8	23.3	21.0	17.5	14.6	12.3	10.4	8.8	7.5	D
5" 7GA 24'	23.3	21.0	19.0	15.6	12.9	10.7	9.0	7.5	6.3	D
5" 7GA 26'	20.0	18.0	16.2	13.2	10.7	8.9	7.3	6.0	4.8	D
5" 7GA 30'	16.4	14.6	13.0	10.3	7.9	6.5	5.2	4.0	3.1	D
6" 7GA 24'	35.0	30.8	28.5	23.7	19.6	16.7	14.0	11.8	10.2	J
6" 7GA 26'	29.2	26.2	23.7	19.3	15.9	13.2	11.0	8.9	7.5	J
6" 7GA 30'	23.6	21.2	19.0	15.2	12.3	9.9	8.0	6.4	5.0	J
6" 7GA 35'	17.6	15.2	13.6	10.7	8.2	6.2	4.6	3.2	2.1	J
6" 7GA 39'	13.9	11.9	10.4	7.7	5.5	3.8	2.4	1.2	0.2	J

All LSI Industries' poles are guaranteed to meet the EPA requirements listed. LSI Industries is not responsible if a pole order has a lower EPA rating than the indicated wind-loading zone where the pole will be located.

CAUTION: This guarantee does not apply if the pole/bracket/fixture combination is used to support any other items such as flags, pennants, or signs, which would add stress to the pole. LSI Industries cannot accept responsibility for harm or damage caused in these situations.





Slice Medium - SLM Outdoor LED Area Light

The Slice's sleek design makes it perfectly-suited for Commercial & Industrial applications, while its cost-effective die-cast aluminum housing makes its acquisition cost very competitive. The Slice offers high performance silicone optics, die cast aluminum housing, 42,000+ lumens and is available with integral Airlink Synapse controls.

Features & Specifications

Optical System

- State-of-the-Art one piece silicone optic sheet delivers industry leading optical control with an integrated gasket to provide IP66 rated sealed optical chamber in 1 component.
- Proprietary silicone refractor optics provide exceptional coverage and uniformity in IES Types 2, 3, 5W, FT and FTA.
- Silicone optical material does not yellow or crack with age and provides a typical light transmittance of 93%.
- Zero uplight.
- Available in 5000K, 4000K, 3000K, and 2700K color temperatures per ANSI C78.377. Also available in Phosphor Converted Amber, consult factory for availability.
- Minimum CRI of 70. Optional 80 CRI available, consult factory for lead time.
- Integral Louver (IL) option available for improved back-light control without sacrificing street side performance. See page 5 for more details.

Electrical

- High-performance driver features over-voltage, under-voltage, short-circuit and over temperature protection.
- 0-10V dimming (10% - 100%) standard.
- Standard Universal Voltage (120-277 Vac) Input 50/60 Hz or optional High Voltage (347-480 Vac).
- L80 Calculated Life: >100k Hours (See Lumen Maintenance on Page 3)
- Total harmonic distortion: <20%
- Operating temperature: -40°C to +50°C (-40°F to +122°F). 42L lumen package rated to +40°C.
- Power factor: >.90
- Input power stays constant over life.
- Field replaceable surge protection device meets a minimum Category C Low operation (per ANSI/IEEE C62.41.2).
- High-efficacy LEDs mounted to metal-core circuit board to maximize heat dissipation
- Terminal block provided accepts up to 10ga wire.
- Components are fully encased in potting material for moisture resistance. Driver complies with FCC standards. Driver and key electronic components can easily be accessed.



Dimmable



WIRELESS CONTROLS

IP66

ARRA
Funding Compliant

USA

TITLE 24
COMPLIANTida
DARK SKY APPROVED

DLC LISTED

DLC LISTED
PREMIUM

Product Dimensions

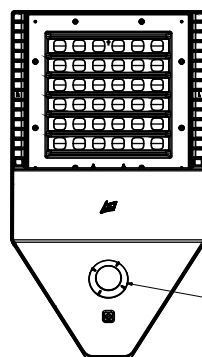
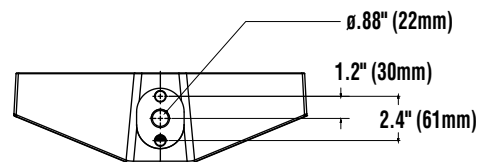
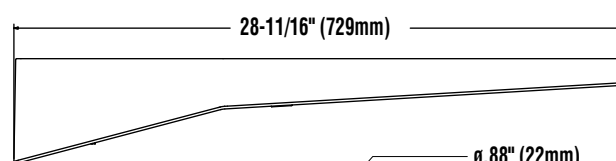
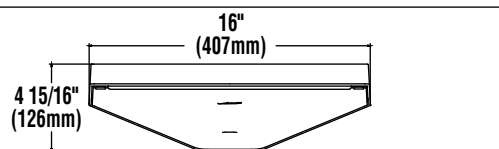

IMS Motion Sensor

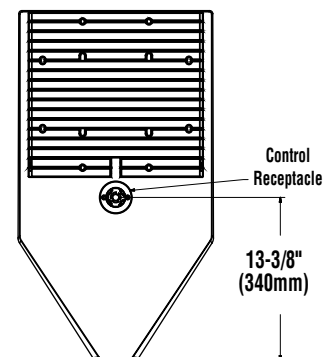
Control
Receptacle13-3/8"
(340mm)

Bottom View

Top View



Slice Medium - SLM Outdoor LED Area Light

Features & Specifications (Cont.)

Construction

- Rugged die-cast aluminum housing contains factory prewired driver and optical unit. Cast aluminum wiring access door located underneath.
- Designed to mount to square poles.
- Luminaire is proudly manufactured in the U.S. of U.S. and imported parts.
- IP66 rated luminaire protects integral components from harsh environments.
- 3G rated for ANSI C136.31 high vibration applications
- Fixtures are finished with LSI's DuraGrip® polyester powder coat finishing process. The DuraGrip finish withstands extreme weather changes without cracking or peeling. Other standard LSI finishes available. Consult factory.
- Shipping weight: 30 lbs in carton.

Controls

Wireless Controls System

To make this fixture AirLink ready, simply order one of the following options:

- The integrated [Wireless Lighting Controller](#): ALSC or ALSCH (see ordering guide) as the controls option, or
- Integrated Wireless Controller option (above) with integrated motion sensor: ALSCS (ordering guide for mounting heights) or
- The 7-Pin Photoelectric Control Receptacle: CR7P as the controls option; and either the [5-Pin](#) or [7-Pin Twist Lock Controller](#): ALSC UNV TL5 or ALSC UNV TL7 as an accessory

To see how the components of AirLink system work together, reference the diagram in the controls section of this specsheet. For more information on our AirLink products, visit our website: www.lsi-airlink.com/airlink-synapse/

Stand-Alone Controls

- The integral passive infrared motion sensor (IMS) activates switching of luminaire light levels (see the controls section for more details).
- The 7-pin ANSI C136.41-2013 photocontrol receptacle option (CR7P) is available for twist lock photocontrols or wireless control modules.
- The Button Type Photocells (PCI) are capable of switching luminaires ON/OFF in response to the amount of available daylight.

Installation

- A single fastener secures the hinged door, underneath the housing and provides quick & easy access to the electrical compartment for installing/servicing.
- Included terminal block provides quick and easy on-site wiring.
- Utilizes LSI's traditional 3" drill pattern for easy fastening of LSI products. (See drawing on page 1)

Warranty

- LSI LED Fixtures carry a 5-year warranty.

Listings

- Listed to UL 1598 and UL 8750.
- RoHS Compliant.
- American Recovery and Reinvestment Act Funding Compliant.
- IDA compliant; with 3000K color temperature selection.
- Title 24 Compliant; see local ordinance for qualification information.
- Suitable For wet Locations.
- IP66 rated Luminaire. IP66 rated optical chamber.
- 3G rated for ANSI C136.31 high vibration applications

Performance

ELECTRICAL DATA (AMPS)*							
Lumens	Watts	120V	208V	240V	277V	347V	480V
9L	68.2	0.6A	0.3A	0.3A	0.2A	0.2A	0.1A
12L	93.1	0.8A	0.4A	0.4A	0.3A	0.3A	0.2A
18L	148.5	1.2A	0.7A	0.6A	0.5A	0.4A	0.3A
24L	188.8	1.6A	0.9A	0.8A	0.7A	0.5A	0.4A
30L	248.6	2.1A	1.2A	1.0A	0.9A	0.7A	0.5A
36L	317.8	2.6A	1.5A	1.3A	1.1A	0.9A	0.7A
42L	393.4	3.3A	1.9A	1.6A	1.4A	1.1A	0.8A

*Electrical data at 25C (77F). Actual wattage may differ by +/-10%

ELECTRICAL DATA - PHOSPHOR CONVERTED AMBER (AMPS)*							
Lumens	Watts	120V	208V	240V	277V	347V	480V
9L	74.3	0.6A	0.4A	0.3A	0.3A	0.2A	0.2A
12L	102.9	0.9A	0.5A	0.4A	0.4A	0.3A	0.2A

*Electrical data at 25C (77F). Actual wattage may differ by +/-10%

RECOMMENDED LUMEN MAINTENANCE ¹ (24-42L)					
Ambient	Initial ²	25 hr ²	50 hr ²	75 hr ³	100 hr ³
0-40 C	100%	100%	97%	94%	92%

RECOMMENDED LUMEN MAINTENANCE ¹ (9-18L)					
Ambient	Initial ²	25 hr ²	50 hr ²	75 hr ³	100 hr ³
0-50 C	100%	96%	91%	87%	83%

- 1- Lumen maintenance values at 25C are calculated per TM-21 based on LM-80 data and in-situ testing.
- 2- In accordance with IESNA TM-21-11, Projected Values represent interpolated value based on time durations that are within six times the IESNA LM-80-08 total test duration for the device under testing.
- 3- In accordance with IESNA TM-21-11, Calculated Values represent time durations that exceed six times the IESNA LM-80-08 total test duration for the device under testing

DELIVERED LUMENS*					
Lumen Package	Distribution	Phosphor Converted Amber			Wattage
		Delivered Lumens	Efficacy	BUG Rating	
9L	2	5958	80	B2-U0-G1	74
	2 IL	3735	50	B0-U0-G1	
	3	6196	83	B1-U0-G1	
	3 IL	4205	56	B0-U0-G1	
	5W	5528	74	B3-U0-G1	
	FT	5922	79	B1-U0-G2	
	FT IL	3712	50	B0-U0-G1	
	FTA	5997	80	B2-U0-G2	
12L	FTA IL	4254	57	B0-U0-G1	103
	2	7559	73	B2-U0-G2	
	2 IL	4738	46	B0-U0-G1	
	3	7860	76	B2-U0-G2	
	3 IL	5335	52	B0-U0-G1	
	5W	7013	68	B3-U0-G2	
	FT	7513	73	B2-U0-G2	
	FT IL	4709	46	B0-U0-G2	
	FTA	7608	74	B2-U0-G2	
	FTA IL	5397	52	B0-U0-G1	

*LED Chips are frequently updated therefore values are nominal

LUMINAIRE EPA CHART - SLM									
Tilt Degree		0°	30°	45°	Tilt Degree		0°	30°	45°
Single	Single	0.5	2.1	2.6	T90°	T90°	1.2	2.9	3.6
D180°	D180°	1.1	2.1	2.6	TN120°	TN120°	1.3	4.4	5.4
D90°	D90°	0.9	2.5	3.1	O90°	O90°	1.2	2.9	3.6

Specifications and dimensions subject to change without notice.



Slice Medium - SLM Outdoor LED Area Light

DELIVERED LUMENS*															
Lumen Package	Distribution	CRI	2700K CCT			3000K CCT			4000K CCT			5000K CCT			Wattage
			Delivered Lumens	Efficacy	BUG Rating	Delivered Lumens	Efficacy	BUG Rating	Delivered Lumens	Efficacy	BUG Rating	Delivered Lumens	Efficacy	BUG Rating	
9L	2	70	8349	122	B2-U0-G2	8576	125	B2-U0-G2	9396	137	B2-U0-G2	9784	143	B2-U0-G2	69
	2 IL	70	5185	76	B0-U0-G1	5326	78	B0-U0-G1	5835	85	B0-U0-G1	6076	89	B0-U0-G1	
	3	70	8571	125	B1-U0-G2	8804	129	B1-U0-G2	9646	141	B2-U0-G2	10044	147	B2-U0-G2	
	3 IL	70	6283	92	B0-U0-G2	6454	94	B0-U0-G2	7071	103	B0-U0-G2	7363	107	B0-U0-G2	
	5W	70	8158	119	B3-U0-G2	8380	122	B3-U0-G2	9181	134	B3-U0-G2	9560	140	B4-U0-G2	
	FT	70	8337	122	B2-U0-G2	8563	125	B2-U0-G2	9382	137	B2-U0-G2	9769	143	B2-U0-G2	
	FT IL	70	5393	79	B0-U0-G2	5540	81	B0-U0-G2	6069	89	B0-U0-G2	6320	92	B0-U0-G2	
	FTA	70	8459	123	B2-U0-G2	8689	127	B2-U0-G2	9520	139	B2-U0-G2	9913	145	B2-U0-G2	
FTA IL	70	6200	91	B1-U0-G1	6369	93	B1-U0-G1	6978	102	B1-U0-G1	7266	106	B1-U0-G1		
12L	2	70	11157	119	B2-U0-G2	11461	122	B2-U0-G2	12556	134	B3-U0-G2	13075	139	B3-U0-G2	94
	2 IL	70	6929	74	B1-U0-G1	7117	76	B1-U0-G2	7798	83	B1-U0-G2	8119	86	B1-U0-G2	
	3	70	11454	122	B2-U0-G2	11766	125	B2-U0-G2	12890	137	B2-U0-G2	13423	143	B2-U0-G2	
	3 IL	70	8396	89	B0-U0-G2	8625	92	B0-U0-G2	9449	101	B0-U0-G2	9839	105	B0-U0-G2	
	5W	70	10902	116	B4-U0-G2	11199	119	B4-U0-G2	12269	131	B4-U0-G2	12775	136	B4-U0-G2	
	FT	70	11141	119	B2-U0-G2	11444	122	B2-U0-G2	12538	133	B2-U0-G3	13055	139	B2-U0-G3	
	FT IL	70	7207	77	B0-U0-G2	7403	79	B0-U0-G2	8110	86	B0-U0-G2	8445	90	B0-U0-G2	
	FTA	70	11304	120	B2-U0-G2	11612	124	B2-U0-G2	12722	135	B2-U0-G2	13247	141	B2-U0-G2	
FTA IL	70	8286	88	B1-U0-G1	8511	91	B1-U0-G1	9325	99	B1-U0-G1	9710	103	B1-U0-G1		
18L	2	70	16714	112	B3-U0-G3	17168	115	B3-U0-G3	18809	126	B3-U0-G3	19586	131	B3-U0-G3	150
	2 IL	70	10379	69	B1-U0-G2	10662	71	B1-U0-G2	11681	78	B1-U0-G2	12163	81	B1-U0-G2	
	3	70	17158	115	B2-U0-G3	17625	118	B2-U0-G3	19310	129	B3-U0-G3	20107	134	B3-U0-G3	
	3 IL	70	12578	84	B1-U0-G3	12920	86	B1-U0-G3	14155	95	B1-U0-G3	14739	99	B1-U0-G3	
	5W	70	16331	109	B4-U0-G2	16776	112	B4-U0-G2	18379	123	B4-U0-G2	19138	128	B5-U0-G3	
	FT	70	16689	112	B3-U0-G3	17143	115	B3-U0-G3	18781	126	B3-U0-G4	19557	131	B3-U0-G4	
	FT IL	70	10795	72	B1-U0-G2	11089	74	B1-U0-G2	12149	81	B1-U0-G3	12651	85	B1-U0-G3	
	FTA	70	16934	113	B3-U0-G3	17395	116	B3-U0-G3	19058	127	B3-U0-G3	19844	133	B3-U0-G3	
FTA IL	70	12412	83	B1-U0-G1	12750	85	B1-U0-G2	13969	93	B1-U0-G2	14546	97	B1-U0-G2		
24L	2	70	20880	112	B3-U0-G3	22701	121	B4-U0-G3	24276	130	B4-U0-G3	24784	133	B4-U0-G3	187
	2 IL	70	13100	70	B1-U0-G2	14243	76	B1-U0-G2	15231	81	B1-U0-G2	15550	83	B1-U0-G2	
	3	70	21739	116	B3-U0-G3	23636	126	B3-U0-G4	25275	135	B3-U0-G4	25804	138	B3-U0-G4	
	3 IL	70	15828	85	B1-U0-G3	17209	92	B1-U0-G3	18403	98	B1-U0-G4	18788	100	B1-U0-G4	
	5W	70	20632	110	B5-U0-G3	22432	120	B5-U0-G3	23988	128	B5-U0-G3	24490	131	B5-U0-G3	
	FT	70	21611	116	B3-U0-G4	23496	126	B3-U0-G4	25126	134	B3-U0-G4	25652	137	B3-U0-G4	
	FT IL	70	13692	73	B1-U0-G3	14886	80	B1-U0-G3	15919	85	B1-U0-G3	16252	87	B1-U0-G3	
	FTA	70	21496	115	B3-U0-G3	23371	125	B3-U0-G3	24992	134	B3-U0-G3	25515	136	B3-U0-G3	
FTA IL	70	15226	81	B1-U0-G2	16555	89	B1-U0-G2	17703	95	B2-U0-G2	18073	97	B2-U0-G2		
30L	2	70	26581	108	B4-U0-G3	28900	117	B4-U0-G3	30905	125	B4-U0-G3	31551	128	B4-U0-G3	247
	2 IL	70	16677	68	B1-U0-G2	18132	73	B1-U0-G2	19390	79	B1-U0-G2	19796	80	B1-U0-G2	
	3	70	27675	112	B3-U0-G4	30089	122	B3-U0-G4	32176	130	B3-U0-G4	32850	133	B3-U0-G4	
	3 IL	70	20150	82	B1-U0-G4	21908	89	B1-U0-G4	23428	95	B1-U0-G4	23918	97	B1-U0-G4	
	5W	70	26266	106	B5-U0-G3	28557	116	B5-U0-G3	30538	124	B5-U0-G4	31177	126	B5-U0-G4	
	FT	70	27512	111	B3-U0-G4	29912	121	B3-U0-G4	31987	130	B3-U0-G4	32656	132	B3-U0-G5	
	FT IL	70	17430	71	B1-U0-G3	18951	77	B1-U0-G4	20266	82	B1-U0-G4	20690	84	B1-U0-G4	
	FTA	70	27365	111	B3-U0-G3	29752	120	B4-U0-G3	31816	129	B4-U0-G3	32482	132	B4-U0-G3	
FTA IL	70	19384	78	B2-U0-G2	21075	85	B2-U0-G2	22537	91	B2-U0-G2	23008	93	B2-U0-G2		
36L	2	70	32214	102	B4-U0-G3	35025	111	B4-U0-G3	37454	118	B4-U0-G3	38238	121	B4-U0-G4	317
	2 IL	70	20212	64	B1-U0-G2	21975	69	B1-U0-G3	23499	74	B2-U0-G3	23991	76	B2-U0-G3	
	3	70	33540	106	B3-U0-G4	36466	115	B3-U0-G5	38996	123	B3-U0-G5	39812	126	B3-U0-G5	
	3 IL	70	24421	77	B1-U0-G4	26551	84	B1-U0-G4	28393	90	B1-U0-G4	28987	92	B1-U0-G5	
	5W	70	31832	101	B5-U0-G4	34609	109	B5-U0-G4	37010	117	B5-U0-G4	37785	119	B5-U0-G4	
	FT	70	33342	105	B3-U0-G5	36251	114	B3-U0-G5	38766	122	B4-U0-G5	39577	125	B4-U0-G5	
	FT IL	70	21125	67	B1-U0-G4	22968	73	B1-U0-G4	24561	78	B1-U0-G4	25075	79	B1-U0-G4	
	FTA	70	33164	105	B4-U0-G3	36058	114	B4-U0-G4	38559	122	B4-U0-G4	39366	124	B4-U0-G3	
FTA IL	70	23492	74	B2-U0-G2	25541	81	B2-U0-G2	27313	86	B2-U0-G2	27885	88	B2-U0-G2		
42L	2	70	36785	94	B4-U0-G3	39994	103	B5-U0-G4	42768	110	B5-U0-G4	43663	112	B5-U0-G4	390
	2 IL	70	23079	59	B1-U0-G3	25093	64	B2-U0-G3	26833	69	B2-U0-G3	27395	70	B2-U0-G3	
	3	70	38299	98	B3-U0-G5	41640	107	B4-U0-G5	44528	114	B4-U0-G5	45460	117	B4-U0-G5	
	3 IL	70	27886	72	B1-U0-G4	30319	78	B1-U0-G5	32422	83	B1-U0-G5	33100	85	B1-U0-G5	
	5W	70	36349	93	B5-U0-G4	39520	101	B5-U0-G4	42261	108	B5-U0-G4	43145	111	B5-U0-G4	
	FT	70	38073	98	B4-U0-G5	41395	106	B4-U0-G5	44266	114	B4-U0-G5	45192	116	B4-U0-G5	
	FT IL	70	24122	62	B1-U0-G4	26226	67	B1-U0-G4	28045	72	B1-U0-G4	28632	73	B1-U0-G4	
	FTA	70	37870	97	B4-U0-G4	41174	106	B4-U0-G4	44030	113	B4-U0-G4	44951	115	B4-U0-G4	
FTA IL	70	26825	69	B2-U0-G2	29165	75	B2-U0-G2	31188	80	B2-U0-G2	31841	82	B2-U0-G2		

*LED Chips are frequently updated therefore values are nominal

Specifications and dimensions subject to change without notice.



Slice Medium - SLM Outdoor LED Area Light

Performance (Cont.)

All published luminaire photometric testing performed to IESNA LM-79 standards. ISO footcandle plots below demonstrate the Slice (SLM) light patterns only. Not for total fixture output. For complete specifications and IES files, see website.

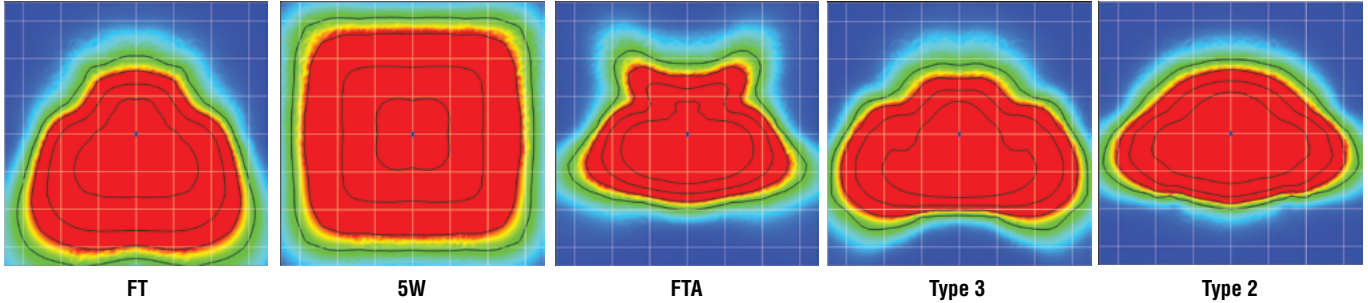

Ordering Guide

TYPICAL ORDER EXAMPLE: **SLM LED 36L SIL FTA UNV DIM 50 ALSC BRZ IL**

Luminaire Prefix	Light Source	Lumen Package	Light Output	Distribution	Orientation ¹¹	Voltage	Driver
SLM Slice Medium	LED	9L - 9,000 lms 12L - 12,000 lms 18L - 18,000 lms 24L - 24,000 lms 30L - 30,000 lms 36L - 36,000 lms 42L - 42,000 lms *Consult factory for program- mable wattages and lumen packages	SIL - Silicone	2 - Type 2 3 - Type 3 5W - Type 5 Wide ¹¹ FT - Type Forward Throw FTA - Forward Throw Automotive	(blank) - standard L - Optics rotated left 90 R - Optics rotated right 90	UNV - Universal Voltage (120-277V) HV - High Voltage (347-480V)	DIM - 0-10v Dimming (0-10%)

Color Temp	Color Rendering	Controls	Finish	Options
50 - 5,000 CCT 40 - 4,000 CCT 30 - 3,000 CCT 27 - 2,700 CCT ¹ AMB - Amber ¹	70CRI - 70 CRI 80CRI - 80 CRI ¹	(Blank) - None Wireless Controls System ALSC - AirLink Synapse Control System ^{2,3} ALSCH - AirLink Synapse Control System ^{3,4,10} Host / Satellite IMSS - Integral motion & Daylight Sensor 24V (for use with ALSCH/ALSCH) ^{6,7,14} Stand-Alone Controls EXT - 0-10v Dimming ⁵ IMS - Integral Motion & Daylight Sensor ^{6,7}	BRZ - Bronze BLK - Black GPT - Graphite MSV - Metallic Silver WHT - White PLP - Platinum Plus SVG - Satin Verde Green	(Blank) - None Button Type Photocells ⁹ PC1120 - 120V PC1208 - 208V PC1240 - 240V PC1277 - 277V PC1347 - 347V PCR7P ⁹ - 7 Pin Photoelectric Control Receptacle IL - Integral Louver HSS



Slice Medium - SLM Outdoor LED Area Light

Accessory Ordering Information⁸

Description	Order Number	Description	Order Number
PC 120 Photocell for use with PCR option (120v) ¹⁴	122514	PMOS24 - 24V Pole-Mount Occupancy Sensor ¹⁵	663284CLR
PC208-277 Photocell for use with PCR option (208V, 240V, 277V) ¹⁴	122515	FK120 Single Fusing (120V) ¹³	FK120
PC347 Photocell for use with PCR option (347V) ¹⁴	122516	FK277 Single Fusing (277V) ¹³	FK277
PC480 Photocell for use with PCR option (480V) ¹⁴	1225180	DFK480 Double Fusing (480V) ¹³	DFK480
ALSC UNV TL5 - AirLink 5 ¹²	661409	BLS XBO WM CLR Wall Mount Bracket ¹⁵	382132CLR
ALSC UNV TL7 - AirLink 7 ¹²	661410	IMS/PC Remote Configurator Tool	5849929
		IL - Integral louver HSS	684812

FOOTNOTES:

- 1 - Consult Factory for availability & Lead Time.
- 2 - Not available with ALSCH, PCR7P, EXT and Button Type Photocells.
- 3 - Not available in HV.
- 4 - Not available with ALSC, PCR7P, EXT and Button Type Photocells.
- 5 - Not compatible with IMS, Wireless Controls System, Button Type Photocells and PCR7P
- 6 - Not available with EXT and Button Type Photocells.
- 7 - IMS is a Dual Sensor (Daylight & Motion) which is field adjustable, via a hand held Remote Configurator Tool, which must be ordered separately. See Accessory Ordering Information.⁷
- 8 - Not available with EXT, IMS, Wireless Controls Systems and PCR7P.

- 9 - Not available with ALSC, ALSCH, Button Type Photocells, IMS. Photocell must be ordered separately. 7 pin standard. See Accessory Ordering Information.
- 10 - See ALSCH configuration support table on page 2.
- 11 - 90L & 90R option not available on "Type 5W" distribution. See Options.
- 12 - Factory installed PCR7P option required. See Accessories.
- 13 - Fusing must be located in hand hole of pole.
- 14 - Not available with Wireless Control systems and IMS.
- 15 - "CLR" denotes finish. See Finish options.
- 16 - Must be used with ALSC or ALSCH controls.

Accessories/Options

Integral Louver (IL)

Accessory Integral Louver available for improved back-light control without sacrificing street side performance. LSI's Integral Louver (IL) option delivers backlight control that significantly reduces light spill behind the pole for applications with pole locations close to adjacent properties. The integrated louvers' design maximizes forward-reflected light while - reducing glare, maintaining the optical distribution selected, and most importantly, eliminating light trespass.

Luminaire Shown with Integral Louver (IL)



7 Pin Photoelectric Control

7-pin ANSI C136.41-2013 control receptacle option available for twist lock photocontrols or wireless control modules. Control accessories sold separately. Dimming leads from the receptacle will be connected to the driver dimming leads (Consult factory for alternate wiring).

Fixture Shown with CR7P

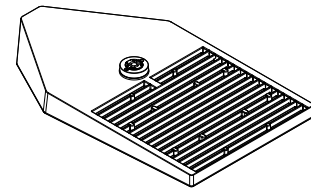

Optics Rotation

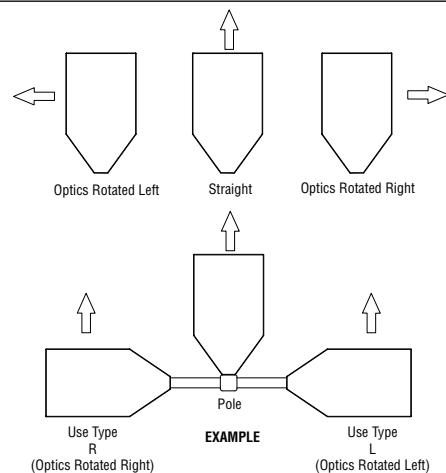



Slice Medium - SLM Outdoor LED Area Light

Stand-alone Controls: Occupancy Sensor (IMS)

The integral passive infrared motion sensor activates switching of luminaire light levels. Standard Factory settings: High level light is activated and increased to full bright upon detection of motion. Lowlight level (10% maximum drive current) is activated when target zone is absent of motion activity for ~5 minutes. See coverage diagram for detection cone.

The Remote Configurator Tool allows for easy and safe programming of each luminaire from ground level. See the [Remote Configurator User Guide](#) for programming instructions.

When ordering the Stand-alone Occupancy Sensor on the fixture, you must include IMS (see ordering guide for mounting height options) as the controls option in the fixture nomenclature.

To order as a motion sensor with the AirLink Wireless Control System, see ordering guide under "Wireless Controls System" and select the ALSCS controls option with the desired mounting height.

IMS Coverage Diagrams

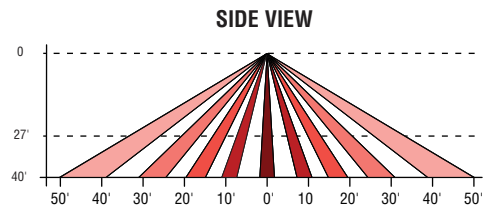
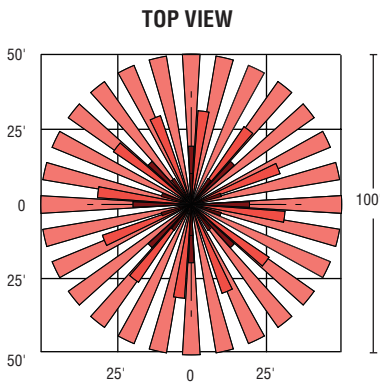

Remote Configurator Tool



Luminaire Shown with IMS





Slice Medium - SLM Outdoor LED Area Light



AirLink™
enabled by Synapse®

The AirLink enabled by Synapse Wireless Lighting Control System is the perfect solution for commercial, industrial and municipal applications, such as: auto dealerships, parking lots, garages, shopping complexes and warehouses.

AirLink utilizes robust wireless communication via 2.4 GHz Self-Healing Mesh Network which not only increases reliability and accuracy of system, but also eliminates single point of failure.

The flexibility of the system make it perfect for new construction and retrofit projects. The user-friendly AirLink web application is accessible through any device with an internet connection and allows for complete customization of the system's features.

Some capabilities of the system include: occupancy/vacancy sensing, daylight harvesting, scheduling, high-end trim, dimming, zone control, BMS integration and energy monitoring.

The AirLink System

Wireless controls & sensors



Wireless & Override Switches



Occupancy/Vacancy & Daylight Sensors



AirLink-integrated Fixtures



AirLink-compatible Fixtures



Circuit & Zone Controllers

Centralized control & integration



Site Manager Controller



Gateway Module



WiFi, Cellular or Ethernet Connection

Simple-to-use software

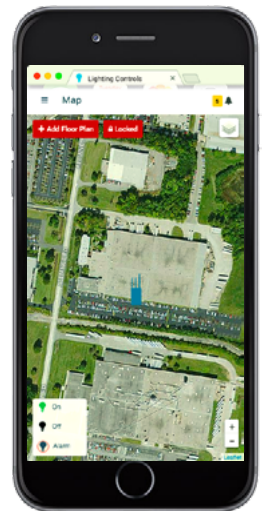

AirLink Site Manger: Lighting control web app

Contact LSI Controls



Sales
controls.sales@lsi-industries.com



Support
controls.support@lsi-industries.com
1 (800) 436-7800 (support, option 8)



More information
For more information on AirLink, visit our website at www.lsi-airlink.com



poles & Brackets

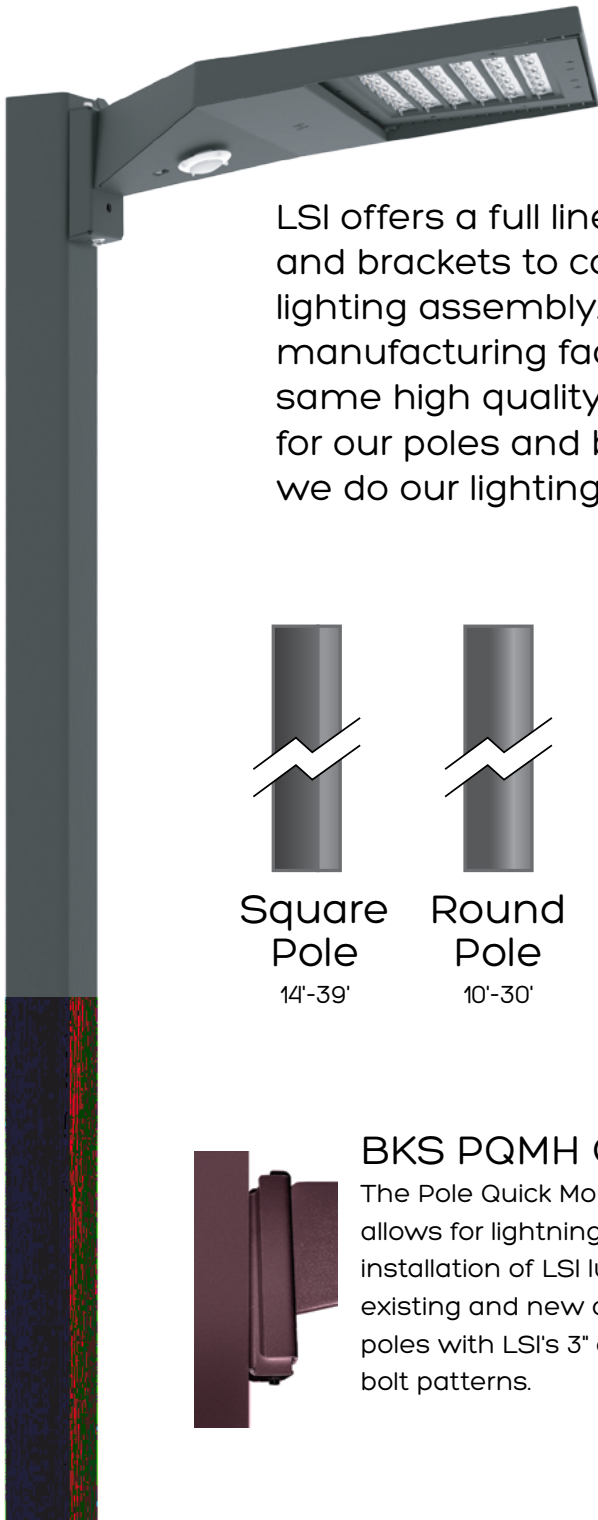

LSI offers a full line of poles and brackets to complete your lighting assembly. Our USA manufacturing facility has the same high quality standards for our poles and brackets as we do our lighting fixtures.



BKA UMB CLR

The 3G rated Universal Mounting Bracket (UMB) allows for seamless integration of LSI Luminaires onto existing or new construction poles. The UMB bracket was designed specifically for square or round (tapered/straight) poles with (2) mounting hole spaces between 3.5"-5".



Square Pole
14'-39'



Round Pole
10'-30'

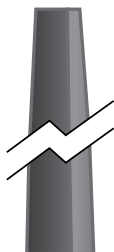

Tapered Pole
20'-39'



BKA ASF CLR

The adjustable Slip Fitter is a 3G rated rugged die cast aluminum adapter to mount LSI luminaires onto a 2" (51mm) IP, 2.375" (60mm) O.D. tenon. The Adjustable Slip Fitter can be rotated 180° allowing for tilting LSI luminaires up to 45° and 90° when using a vertical tenon.



BKS PQMH CLR

The Pole Quick Mount Bracket allows for lightning fast installation of LSI luminaires onto existing and new construction poles with LSI's 3" or 5" standard bolt patterns.

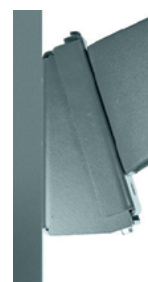

BKS PQM15 CLR

The Pole Quick Mount Bracket allows for preset 15° up tilt of LSI luminaires for greater throw of light and increased vertical illumination as well as fast installation onto poles with LSI's 3" or 5" bolt pattern.

STEEL SQUARE POLES

DIMENSIONS

SQN –
N= 2-3/8" (60mm) O.D. x 4-3/4" (121mm) Tenon

SQB3, SOB5 –
Bolt-On Mount
2-Bolt Pattern

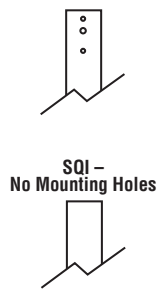
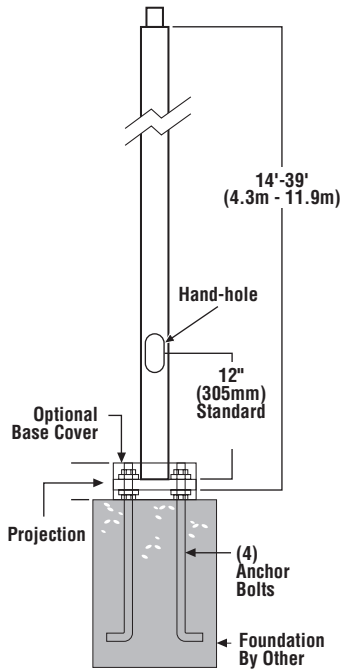

POLE SHAFT - Pole shaft is electro-welded ASTM-A500 Grade C steel tubing with a minimum yield strength of 50,000 psi. On Tenon Mount steel poles, tenon is 2-3/8" O.D. high-strength pipe. Tenon is 4-3/4" in length. Straight poles are 4", 5", and 6" square.

HAND-HOLE - Standard hand-hole location is 12" above pole base. Poles 22' and above have a 3" x 6" reinforced hand-hole. Shorter poles have a 2" x 4" non-reinforced hand-hole.

BASE - Pole base is ASTM-A36 hot-rolled steel plate with a minimum yield strength of 36,000 psi. Two-piece square base cover is optional.

ANCHOR BOLTS - Poles are furnished with anchor bolts featuring zinc-plated double nuts and washers. Galvanized anchor bolts are optional. Anchor bolts conform to ASTM F 1554-07a Grade 55 with a minimum yield strength of 55,000 psi.

GROUND LUG - Ground lug is standard.

DUPLEX RECEPTACLE - Weatherproof duplex receptacle is optional.

GROUND FAULT CIRCUIT INTERRUPTER - Self-testing ground fault circuit interrupter is optional.

FINISHES - Each pole is finished with DuraGrip®, LSI's baked-on polyester-powder finishing process which electrostatically applies and fuses a polyester powder to the pole. Provides an extremely smooth and uniform finish to withstand extreme weather changes without cracking or peeling, and features a five-year limited warranty. Optional DuraGrip® Plus features the added protection of a 3.0 to 5.0 mil thickness of polyester-powder finish plus an inner coating, as well as a seven-year limited warranty.

DETERMINING THE LUMINAIRE/POLE COMBINATION FOR YOUR APPLICATION:

- Select luminaire from luminaire ordering information
- Select bracket configuration if required
- Determine EPA value from luminaire/bracket EPA chart
- Select pole height
- Select MPH to match wind speed in the application area (See windspeed maps).
- Confirm pole EPA equal to or exceeding value from note above
- Consult factory for special wind load requirements and banner brackets

DRILLING LOCATIONS

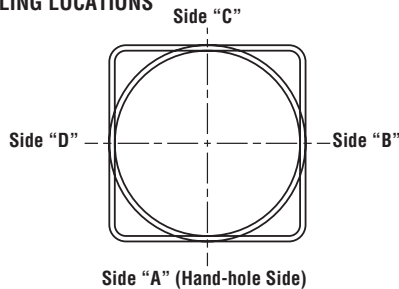

Sides	A	B	C	D
Hand-hole	X			
Single	X			
D180°		X		X
D90°	X			X
T90°	X	X		X
TN120°*	X			
Q90°	X	X	X	X
Single FBO	X			
Double FBO		X		X

*Other two locations will be 120° to the left and right of Side A.

Note: Standard SF and DF pole preparations are located 3/4 of the height of the pole from the base, unless otherwise specified.

SHIPPING WEIGHTS - Steel Square Poles

4" (102mm) sq. 11 Ga. is approximately	7.50 lbs./ft.
4" (102mm) sq. 07 Ga. is approximately	10.00 lbs./ft.
5" (127mm) sq. 11 Ga. is approximately	9.00 lbs./ft.
5" (127mm) sq. 07 Ga. is approximately	12.50 lbs./ft.
6" (152mm) sq. 07 Ga. is approximately	15.40 lbs./ft.
Anchor Bolts (3/4" x 30") (19mm x 762mm)	15 lbs. (7kg)/set
Anchor Bolts (1" x 36") (25mm x 914mm)	30 lbs. (14kg)/set

ARRA
Funding Compliant



Project Name **Maverik** Fixture Type **T14A Pole**
Catalog # **4SQ B3 S11G 17'-6" S BRZ**

11/27/17
© 2017
LSI INDUSTRIES INC.

STEEL SQUARE POLES

POLE ORDERING INFORMATION

TYPICAL ORDER EXAMPLE: **5SQB5 S07G 24 S PLP SF DGP**

Pole Series	Material	Height ²	Mounting Configuration	Pole Finish	Options
Bolt-on Arm Mount - See pole selection guide for patterns and fixture matches. 4SQB3 - 3" Reduced drilling pattern 5SQB3 - 3" Reduced drilling pattern 4SQB5 - 5" Traditional drilling pattern 5SQB5 - 5" Traditional drilling pattern 6SQB5 - 5" Traditional drilling pattern	S11G - 11 Ga. Steel S07G - 07 Ga. Steel	14' 16' 18' 20' 22' 24' 26' 28' 30' 35' 39'	S - Single/Parallel D180° - Double D90° - Double DN90° - Double T90° - Triple TN120° - Triple Q90° - Quad QN90° - Quad N - Tenon Mount (Standard tenon size is 2-3/8" O.D.)	BRZ - Bronze BLK - Black PLP - Platinum Plus WHT - White SVG - Satin Verde Green GPT - Graphite MSV - Metallic Silver	GA - Galvanized Anchor Bolts SF - Single Flood ³ DF - Double Flood ³ DGP - DuraGrip® Plus LAB - Less Anchor Bolts OSXX - Pole preparation for PMOS Occupancy Sensor ⁴
Tenon Mount - See pole selection guide for tenon and fixture/bracket matches. 4SQN 5SQN 6SQN	<div style="border: 1px solid black; padding: 5px; text-align: center;"> Consult Pole Selection Chart on opposite page </div>			<div style="border: 1px solid black; padding: 5px;"> Standard SF and DF pole preparations are located 3/4 of the height of the pole from the base, unless otherwise specified. </div>	
No Mounting Holes - Use with: <ul style="list-style-type: none"> • BKA 4ISF & BKA 5ISF • BKA X4ISF & BKA X5ISF 					
Internal Slip-fitter¹ 4SQI 5SQI					

ACCESSORY ORDERING INFORMATION (Accessories are field installed)		
Description	Order Number	Order Number
4BC - 4" Square Base Cover	122559CLR	Vibration Damper - 4" Square Pole (bolt-on mount only) 172539
5BC - 5" Square Base Cover	122561CLR	Vibration Damper - 5" Square Pole (bolt-on mount only) 172538
6BC - 6" Square Base Cover	122563CLR	Vibration Damper - 6" Square Pole (bolt-on mount only) 178361
ER2 - Weatherproof Duplex Receptacle	122566CLR	PMOS120 - 120V Occupancy Sensor 518030CLR ⁵
GFI - Ground Fault Circuit Interrupter	122567CLR	PMOS208/240 - 208, 240V Occupancy Sensor 534239CLR ⁵
MHP - Mounting Hole Plugs (3 plugs)-for use with 5" traditional drill pattern	132336	PMOS277 - 277V Occupancy Sensor 518029CLR ⁵
MHD - Mounting Hole Weatherproof Decal-for use with 3" reduced drill pattern	340120	PMOS480 - 480V Occupancy Sensor 534240CLR ⁵

FOOTNOTES:

- 1 - See Area Lighting Brackets 3" Reduced Drill Pattern and Area Lighting Brackets - Bolt-on 5" Traditional Drill Pattern spec sheets for Internal Slip-fitter brackets.
- 2 - Pole heights will have +/- 1/2" tolerance.
- 3 - See Flood Lighting Brackets section for choice of FBO brackets.
- 4 - Order PMOS separately. Change "XX" to indicate height and side of pole location for pole preparation. EX: OS18A indicates preparation is to be 18ft. up from pole base on side A. Optimal distance from ground to sensor is 20ft.
- 5 - OSXX option required. Not for use with Metal Halide fixtures

BOLT CIRCLE				
	4" (102mm) square 10-1/8" (257mm) sq.	5" (127mm) square 10-1/8" (257mm) sq.	5" (127mm) square 10-1/8" (257mm) sq.	6" (152mm) square 12" (305mm) sq.
	11" (279mm) Dia. Bolt Circle	11" (279mm) Dia. Bolt Circle	11" (279mm) Dia. Bolt Circle	12" (305mm) Dia. Bolt Circle
	B	C	D	J
Bolt Circle	Slotted 8"-11" (203mm-279mm)	Slotted 9"-11" (229mm-279mm)	Slotted 9"-11" (229mm-279mm)	Slotted 12" (305mm)
Anchor Bolt Size	3/4" x 30" (19mm x 762mm)	3/4" x 30" (19mm x 762mm)	1" x 36" (25mm x 914mm)	1" x 36" (25mm x 914mm)
Anchor Bolt Projection	3-1/4" (83mm)	3-1/4" (83mm)	4" (102mm)	4" (102mm)
Base Plate Opening for Wireway Entry	3-5/8" (92mm)	4-3/4" (121mm)	4-5/8" (117mm)	5-5/8" (143mm)
Base Plate Dimensions	10-1/8" sq. x 3/4" thk. (257mm x 19mm)	10-1/8" sq. x 3/4" thk. (257mm x 19mm)	10-1/8" sq. x 1" thk. (257mm x 25mm)	12" sq. x 1-1/8" thk. (305mm x 29mm)

Note: Base plate illustrations may change without notice. Do not use for setting anchor bolts. Consult factory for the base plate templates.



STEEL SQUARE POLES

Use ONLY with "Wind Speed Map for ASCE7-05"

STEEL SQUARE POLES - ASCE7-05								
POLE	90 MPH	100 MPH	110 MPH	120 MPH	130 MPH	140 MPH	150 MPH	Bolt Circle
4" 11GA 14'	18.7	14.5	11.5	9.1	7.3	5.9	4.6	B
4" 11GA 16'	15.1	11.5	8.9	6.9	5.4	4.1	3.1	B
4" 11GA 18'	12.2	9.1	6.8	5.1	3.7	2.7	1.8	B
4" 11GA 20'	9.5	6.9	4.9	3.4	2.2	1.3	0.5	B
4" 11GA 22'	9.6	7.0	4.7	3.0	1.5	0.5	0.0	B
4" 11GA 24'	7.7	5.3	3.4	1.8	0.4	0.0	0.0	B
4" 11GA 26'	5.7	3.3	1.9	0.6	0.0	0.0	0.0	B
4" 7GA 20'	14.8	11.2	8.4	6.4	4.8	3.5	2.4	B
4" 7GA 22'	14.9	11.0	8.2	6.0	4.4	3.0	1.9	B
4" 7GA 24'	12.4	8.8	6.3	4.4	2.9	1.7	0.8	B
4" 7GA 26'	10.1	6.9	4.6	2.9	1.6	0.5	0.0	B
5" 11GA 16'	29.4	23.0	18.2	14.6	11.8	9.6	7.8	C
5" 11GA 18'	24.2	19.7	14.5	11.4	9.0	7.1	5.5	C
5" 11GA 20'	20.0	14.9	11.5	8.8	6.6	4.9	3.6	C
5" 11GA 22'	20.8	15.5	11.7	8.7	6.4	4.6	3.2	C
5" 11GA 24'	17.2	12.8	9.3	6.6	4.5	3.0	1.6	C
5" 11GA 26'	14.8	10.2	7.1	4.7	2.8	1.4	0.2	C
5" 7GA 20'	30.5	23.7	18.6	14.7	11.7	9.3	7.4	D
5" 7GA 22'	41.2	32.0	25.4	20.3	16.2	13.2	10.5	D
5" 7GA 24'	36.0	27.9	21.8	17.1	13.5	10.7	8.4	D
5" 7GA 26'	32.0	23.8	18.3	14.1	10.9	8.3	6.2	D
5" 7GA 30'	24.1	17.5	13.0	9.4	6.7	4.5	2.8	D
6" 7GA 24'	51.0	39.7	31.3	24.9	19.9	16.0	12.8	J
6" 7GA 26'	44.5	34.2	26.7	20.9	16.4	12.9	10.0	J
6" 7GA 30'	34.3	25.8	19.4	14.6	10.8	7.9	5.4	J
6" 7GA 35'	24.8	17.8	12.5	8.5	5.4	2.9	0.9	J
6" 7GA 39'	18.6	12.4	7.8	4.4	1.6	0.0	0.0	J

All LSI Industries' poles are guaranteed to meet the EPA requirements listed. LSI Industries is not responsible if a pole order has a lower EPA rating than the indicated wind-loading zone where the pole will be located.

CAUTION: This guarantee does not apply if the pole/bracket/fixture combination is used to support any other items such as flags, pennants, or signs, which would add stress to the pole. LSI Industries cannot accept responsibility for harm or damage caused in these situations.



STEEL SQUARE POLES

Use ONLY with "Wind Speed Map for ASCE7-10

STEEL SQUARE POLES - ASCE7-10										
POLE	110 MPH	115 MPH	120 MPH	130 MPH	140 MPH	150 MPH	160 MPH	170 MPH	180 MPH	Bolt Circle
4" 11GA 14'	12.5	11.3	10.2	8.5	6.8	5.8	4.9	4.1	3.6	B
4" 11GA 16'	9.8	8.6	7.9	6.5	5.4	4.4	3.5	2.9	2.2	B
4" 11GA 18'	8.1	7.4	6.7	5.4	4.2	3.4	2.8	2.2	1.7	B
4" 11GA 20'	7.1	6.3	5.6	4.4	3.4	2.7	2.1	1.6	1.1	B
4" 11GA 22'	9.9	8.8	7.9	6.3	5.1	4.0	3.1	2.5	2.0	B
4" 11GA 24'	8.6	7.5	6.8	5.3	4.2	3.3	2.5	1.9	1.3	B
4" 11GA 26'	6.8	6.1	5.5	4.2	3.2	2.3	1.6	1.0	0.6	B
4" 7GA 20'	10.7	9.7	8.7	7.0	5.7	4.6	3.8	3.1	2.5	B
4" 7GA 22'	11.3	10.2	9.1	7.3	5.8	4.7	3.5	2.7	2.1	B
4" 7GA 24'	9.8	8.9	7.8	6.0	4.5	3.5	2.8	2.1	1.6	B
4" 7GA 26'	7.9	7.1	6.1	4.7	3.6	2.8	1.9	1.2	0.7	B
5" 11GA 16'	18.1	16.4	14.8	12.3	10.3	8.7	7.3	6.3	5.3	C
5" 11GA 18'	15.7	14.2	12.8	10.5	8.7	7.3	6.1	5.1	4.3	C
5" 11GA 20'	13.5	12.3	11.1	9.0	7.4	6.0	4.8	3.8	3.1	C
5" 11GA 22'	15.8	14.3	12.6	10.2	8.3	6.5	5.4	4.2	3.5	C
5" 11GA 24'	13.8	12.5	10.8	8.6	6.7	5.2	3.9	3.0	2.1	C
5" 11GA 26'	11.3	10.3	8.9	6.9	5.3	4.0	3.0	2.2	1.5	C
5" 7GA 20'	20.7	18.8	17.0	14.0	11.7	9.8	7.9	7.0	5.9	D
5" 7GA 22'	25.8	23.3	21.0	17.5	14.6	12.3	10.4	8.8	7.5	D
5" 7GA 24'	23.3	21.0	19.0	15.6	12.9	10.7	9.0	7.5	6.3	D
5" 7GA 26'	20.0	18.0	16.2	13.2	10.7	8.9	7.3	6.0	4.8	D
5" 7GA 30'	16.4	14.6	13.0	10.3	7.9	6.5	5.2	4.0	3.1	D
6" 7GA 24'	35.0	30.8	28.5	23.7	19.6	16.7	14.0	11.8	10.2	J
6" 7GA 26'	29.2	26.2	23.7	19.3	15.9	13.2	11.0	8.9	7.5	J
6" 7GA 30'	23.6	21.2	19.0	15.2	12.3	9.9	8.0	6.4	5.0	J
6" 7GA 35'	17.6	15.2	13.6	10.7	8.2	6.2	4.6	3.2	2.1	J
6" 7GA 39'	13.9	11.9	10.4	7.7	5.5	3.8	2.4	1.2	0.2	J

All LSI Industries' poles are guaranteed to meet the EPA requirements listed. LSI Industries is not responsible if a pole order has a lower EPA rating than the indicated wind-loading zone where the pole will be located.

CAUTION: This guarantee does not apply if the pole/bracket/fixture combination is used to support any other items such as flags, pennants, or signs, which would add stress to the pole. LSI Industries cannot accept responsibility for harm or damage caused in these situations.





MLS Mini LED Strip

The mini LED striplight replaces traditional T5 and T8 fluorescent strip luminaires. Ideal for task lighting, restrooms, under/over cabinet, storage closets and display cases. Diffuse acrylic lens provides uniform illumination. The MLS series provides long-life and energy efficiency as well as 0-10V dimming capability.

Features & Specifications

Optical System

- High transmission impact resistant diffuse acrylic lens eliminates bright spots from individual LED's and provides high vertical illumination and visual comfort.
- Use of closely spaced medium-power, high brightness chips provide uniform lens luminance with no dead spots
- Standard in 4000K color temperature.
- Minimum CRI of 80.

Electrical

- High-performance driver features over-voltage, under voltage, short-circuit and over temperature protection.
- 0-10 volt dimming (10% - 100%) standard.
- Standard Universal Voltage (120-277 Vac) Input 50/60 Hz
- L70 Calculated Life: >50k Hours
- Total harmonic distortion: <20%
- Operating temperature: -20°C to +40°C (-4°F to +104°F)
- Power factor: >.90
- Input power stays constant over life.

Construction

- Rigid housing is die-formed thick gauge steel for consistency and strength.
- Removable Lens frame assembly provides quick access to wiring and driver connections.
- Available in 2' or 4' lengths.
- All metal parts are painted after fabrication following treatment with phosphate rust inhibitor. Finish coating of housing reflecting surfaces is with high-reflectance white (minimum 92%) polyester powder.



damp location



Dimmable



UL US LISTED



RoHS COMPLIANT



QUICK SHIP 5-DAY



DLC OPT LISTED

Dimensions

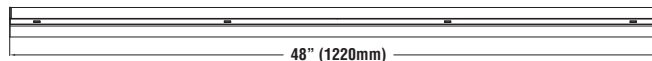
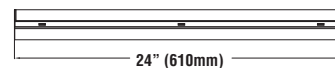
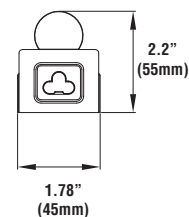



Features & Specifications (Cont.)

Installation

- Installs surface mount to ceiling studs or drywall.
- Comes standard with linking connector feature for continuous row installation.

Warranty

- LSI LED Fixtures carry a 5-year warranty.

Listings

- Listed to UL 1598 and UL 8750.
- RoHS Compliant.
- Suitable For Damp Locations.

Performance

DELIVERED LUMENS*			
MODEL	4000K CCT		Avg. Wattage
	Delivered Lumens	Efficacy	
10L	1133	115	9.8
20L	2134	109	19.5

*LED Chips are frequently updated therefore values are nominal.

ELECTRICAL DATA*				
MODEL	120V	208V	240V	277V
10L	0.08A	0.05A	0.04A	0.04A
20L	0.16A	0.09A	0.08A	0.07A

*Electrical data at 25C (77F). Actual wattage may differ by +/-10%.

Luminaire Ordering Guide

TYPICAL ORDER EXAMPLE: **MLS2 LED 10L CSM UNV DIM 40 U**

Luminaire Prefix	LED Gen	Lumen Package	Optic	Voltage	Driver	Color Temperature	Packaging
MLS2 MLS4	LED	10L- 1000 ¹ 20L - 2000 ²	CSM - Centered Symmetric	UNV - Universal Voltage (120-277V)	DIM - 0-10V	40 - 4000K	U - Single Pack

Notes:

- 1- Only available with MLS2 on the 10L lumen package.
- 2- Only available with MLS4 on the 20L lumen package.

Accessory Ordering Information

Description	Order Number
Remote Emergency Battery Field Installed	658633



Photometry

MLS4-LED-20L-CSM-UNV-DIM-40

Luminaire photometry has been conducted by a NVLAP accredited testing laboratory in accordance with IESNA LM-79-08. As specified by IESNA LM-79-08 the entire luminaire is tested as the source resulting in a luminaire efficiency of 100%.

See <http://www.lsi-industries.com/products/led-lighting-solutions.aspx> for detailed photometric data.

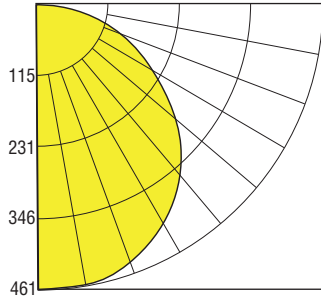

ZONAL LUMEN SUMMARY		
ZONE	LUMENS	% OF LUMINAIRE
0-20	167.7	7.9%
0-30	363.5	17.0%
0-40	610.3	28.6%
0-60	1,158.6	54.3%
0-80	1,626.0	76.2%
0-90	1,795.9	84.1%
10-90	1,753.2	82.1%
20-40	442.6	20.7%
20-50	716.0	33.5%
40-70	801.4	37.5%
60-80	467.3	21.9%
70-80	214.3	10.0%
80-90	169.9	8.0%
90-110	228.6	10.7%
90-120	290.3	13.6%
90-130	323.5	15.2%
90-150	338.6	15.9%
90-180	338.6	15.9%
110-180	110.0	5.2%
0-180	2,134.5	100.0%

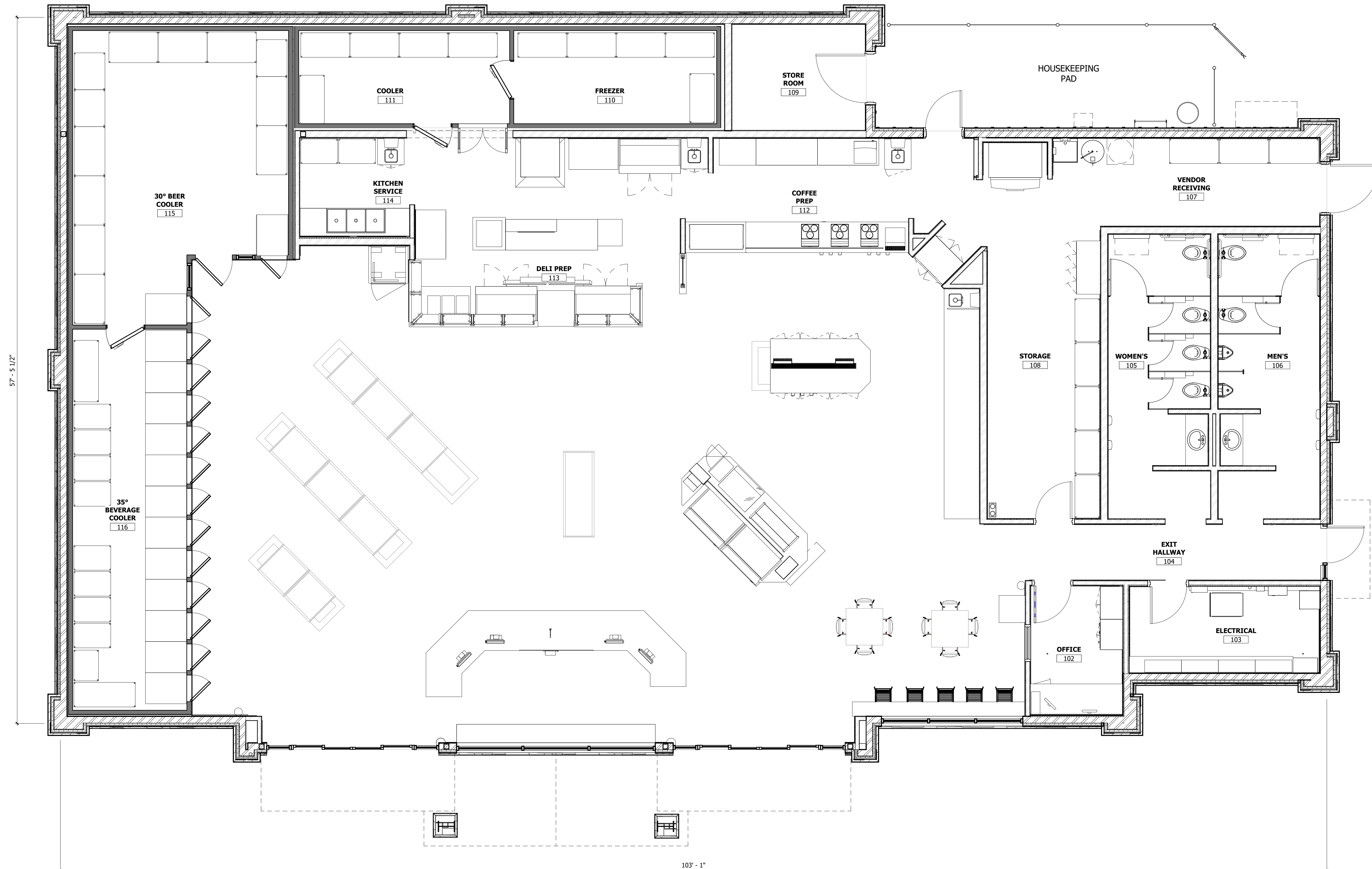

1 FLOOR PLAN
SCALE: 1/4" = 1'-0"

PROPOSED MAVERIK C-STORE

Prototype Version: 50_R_RR_2101
 Building Square Footage: 5,637 SF
 Construction Type/Occupancy Classification: V-B / M

A-1 | FLOOR PLAN



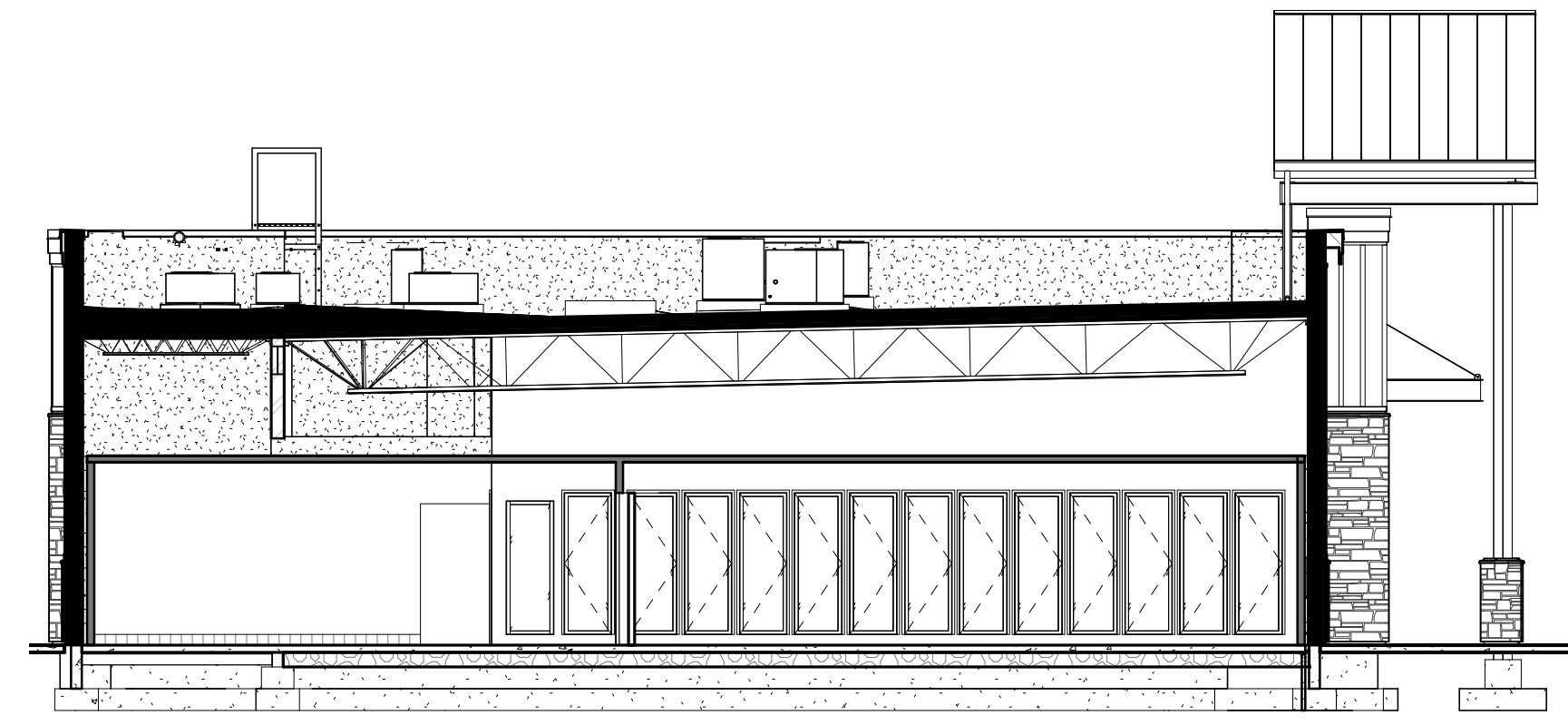

3 BUILDING SECTION
SCALE: 1/8" = 1'-0"

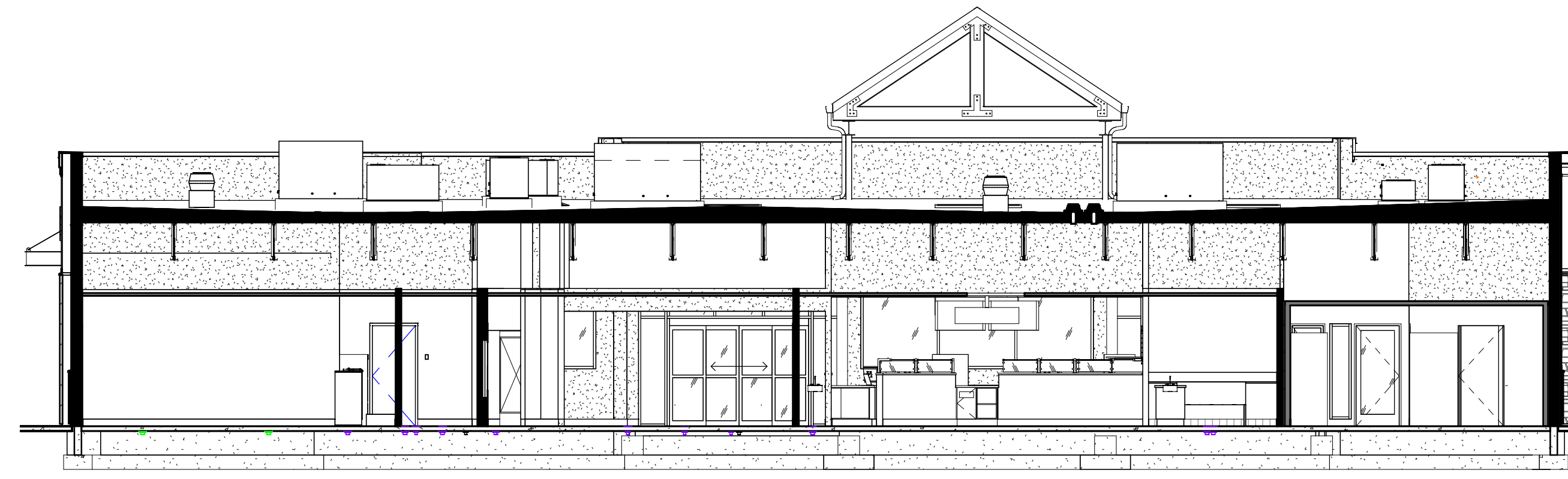

2 BUILDING SECTION
SCALE: 1/8" = 1'-0"

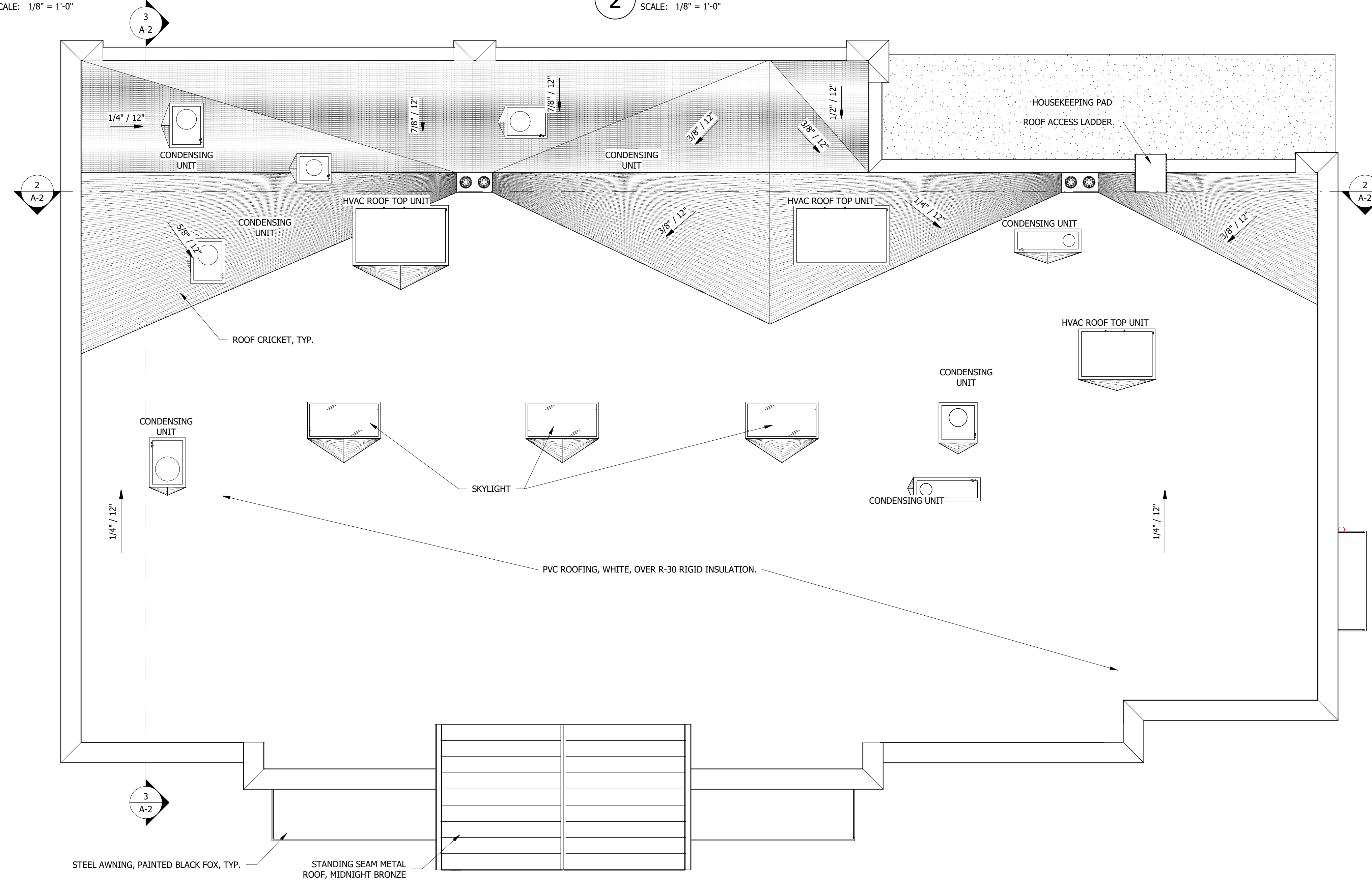

1 ROOF PLAN
SCALE: 3/16" = 1'-0"

PROPOSED MAVERIK C-STORE

Prototype Version: 50_R_RR_2101
 Building Square Footage: 5,637 SF
 Construction Type/Occupancy Classification: V-B / M

A-2 | ROOF PLAN



2 BUILDING PERSPECTIVE
SCALE:



1 BUILDING PERSPECTIVE
SCALE:

PROPOSED MAVERIK C-STORE

Prototype Version: 50_R_RR_2101
 Building Square Footage: 5,637 SF
 Construction Type/Occupancy Classification: V-B / M

A-3 | PERSPECTIVE VIEWS



KEYED NOTES

- 04.05 CULTURED STONE VENEER, SKYLINE, COUNTRY LEDGESTONE
- 04.06 CULTURED STONE VENEER CAP, SKYLINE, COUNTRY LEDGESTONE
- 05.01 PAINTED STEEL, BLACK FOX
- 05.03 PAINTED STEEL, BLACK FOX
- 05.06 MBCI PRE-FINISHED METAL ROOF, 1 3/4" STANDING SEAM, MIDNIGHT BRONZE
- 05.21 PRE-FINISHED METAL COPING, COLOR C-1
- 05.69 STEEL AWNING, COLOR P-9
- 06.04 FIBER CEMENT BOARD & BATTEN SIDING, BB-2
- 06.05 FIBER CEMENT BOARD & BATTEN SIDING, BB-1
- 06.06 FIBER CEMENT TRIM BB-3
- 08.02 ALUMINUM STOREFRONT SYSTEM, DARK BRONZE
- 08.04 HOLLOW METAL DOOR AND FRAME, PAINTED AGED PEWTER
- 08.05 WINDOW, SEE SCHEDULE
- 10.01 ROOF ACCESS LADDER W/ SECURITY GATE, SEE DETAIL 1/AS.11. POWDER COATED COLOR TO MATCH SIDING BB-1
- 32.01 CHAIN LINK FENCE WITH PRIVACY SLATS. COLOR TO MATCH BUILDING FIELD COLOR



2 LEFT ELEVATION
SCALE: 1/4" = 1'-0"



1 FRONT ELEVATION
SCALE: 1/4" = 1'-0"

PROPOSED MAVERIK C-STORE

Prototype Version: 50_R_RR_2101
 Building Square Footage: 5,637 SF
 Construction Type/Occupancy Classification: V-B / M

A-4 | EXTERIOR ELEVATIONS



KEYED NOTES

- 04.05 CULTURED STONE VENEER, SKYLINE, COUNTRY LEDGESTONE
- 04.06 CULTURED STONE VENEER CAP, SKYLINE, COUNTRY LEDGESTONE
- 05.01 PRE-FINISHED GUTTER, BRITTE RED
- 05.03 PAINTED STEEL, BLACK FOX
- 05.06 MBCI PRE-FINISHED METAL ROOF, 1 3/4" STANDING SEAM, MIDNIGHT BRONZE
- 05.21 PRE-FINISHED METAL COPING, COLOR C-1
- 05.69 STEEL AWNING, COLOR P-9
- 06.04 FIBER CEMENT BOARD & BATTEN SIDING, BB-2
- 06.05 FIBER CEMENT BOARD & BATTEN SIDING, BB-1
- 06.06 FIBER CEMENT TRIM BB-3
- 06.30 HORIZONTAL JOINT IN SIDING
- 10.01 ROOF ACCESS LADDER W/ SECURITY GATE, SEE DETAIL 1/A5.11. POWDER COATED COLOR TO MATCH SIDING BB-1
- 32.01 CHAIN LINK FENCE WITH PRIVACY SLATS. COLOR TO MATCH BUILDING FIELD COLOR

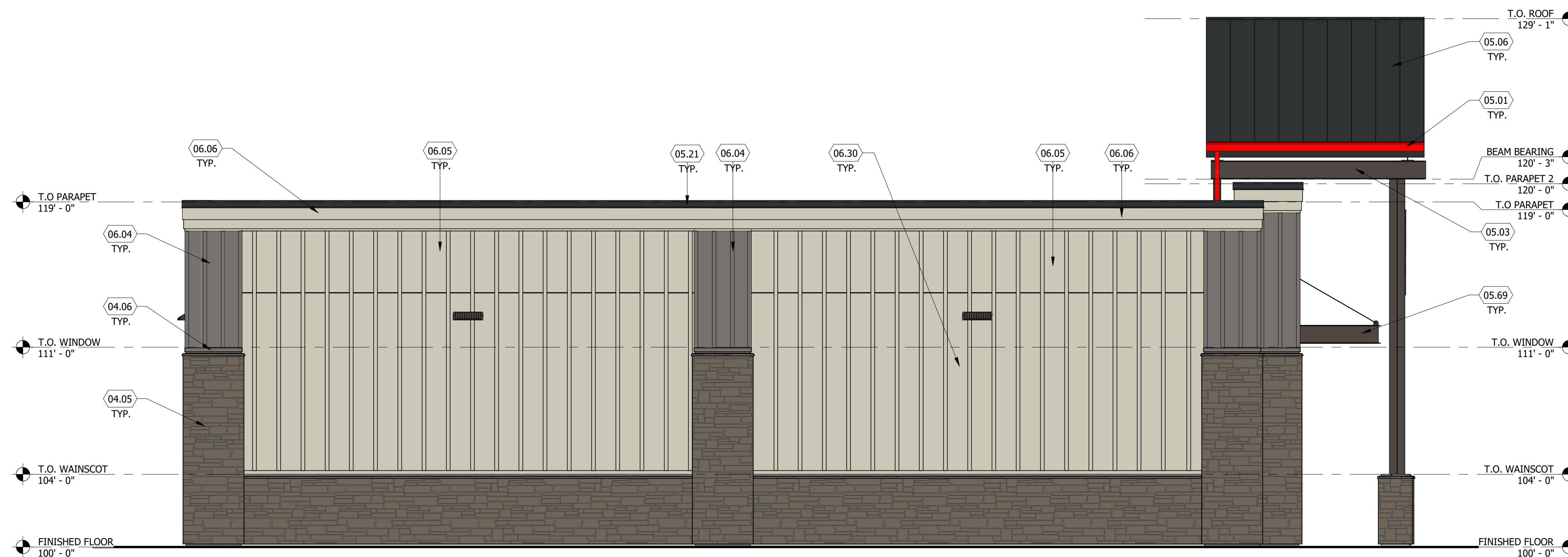

2 RIGHT ELEVATION
SCALE: 1/4" = 1'-0"

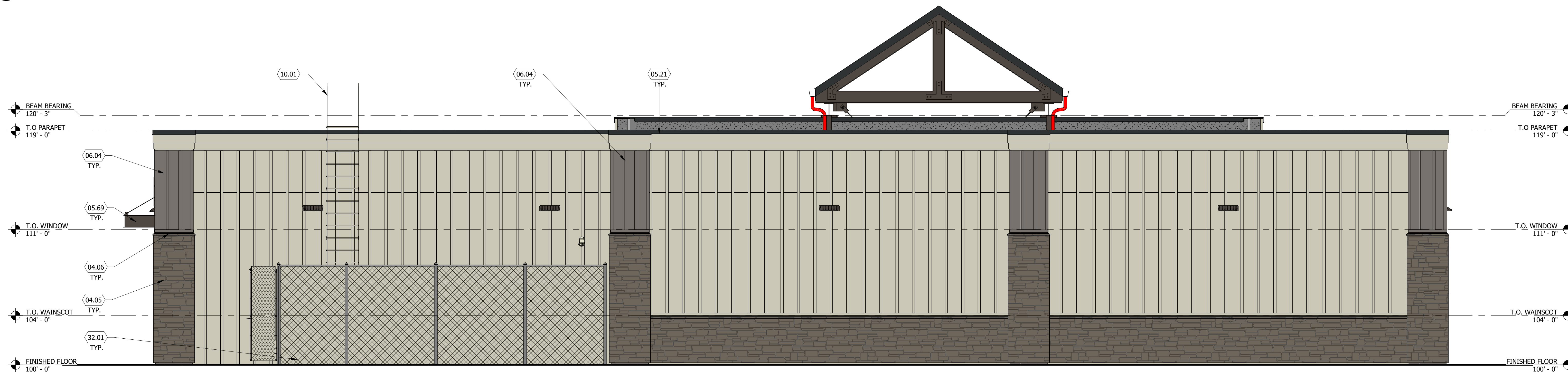

1 REAR ELEVATION
SCALE: 1/4" = 1'-0"

PROPOSED MAVERIK C-STORE

Prototype Version: 50_R_RR_2101
 Building Square Footage: 5,637 SF
 Construction Type/Occupancy Classification: V-B / M

A-5 | EXTERIOR ELEVATIONS



185 S. State Street
 Salt Lake City, Utah 84111

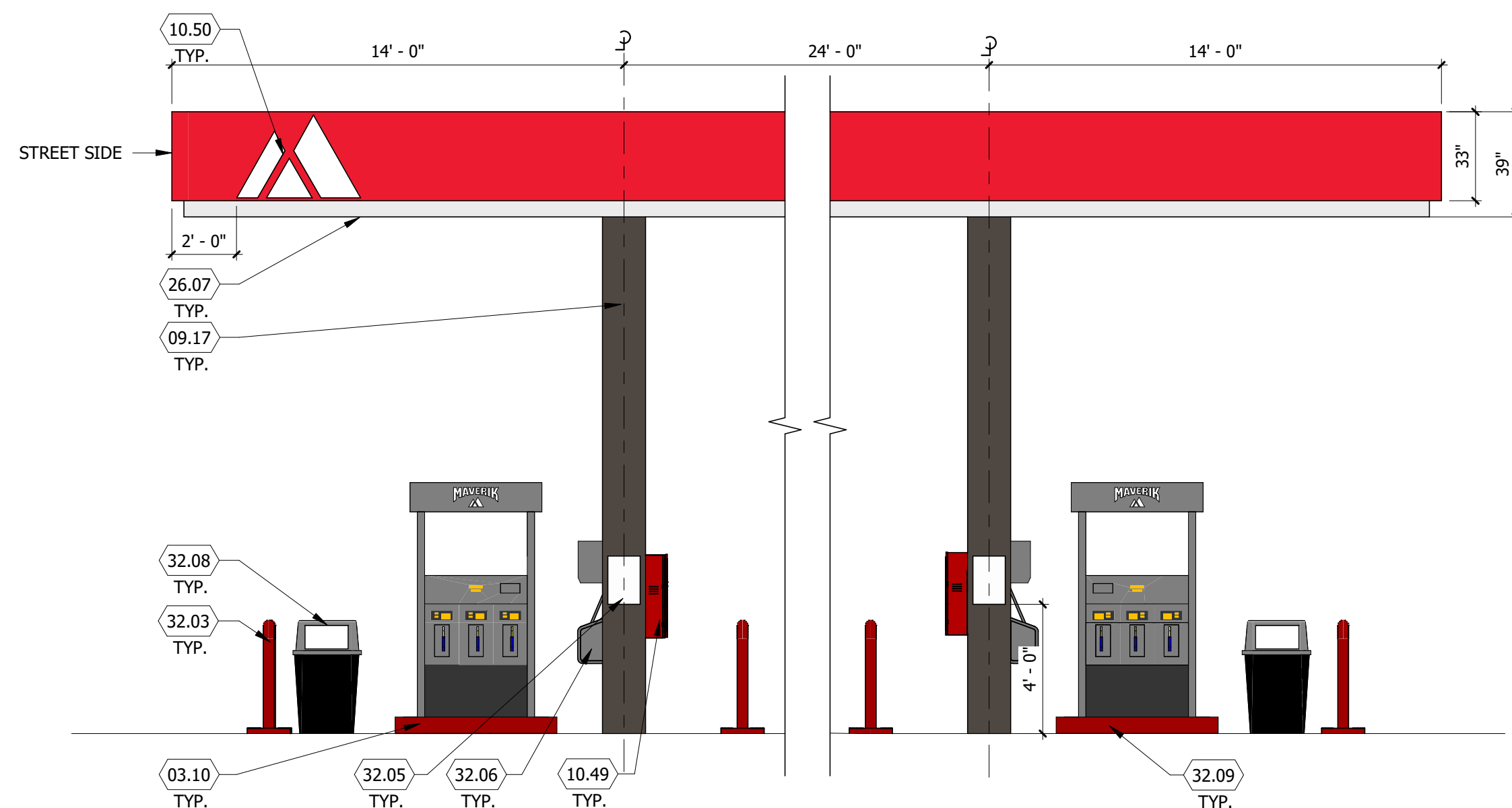

5 FUEL DISPENSING CANOPY - END ELEVATION
SCALE: 1/4" = 1'-0"

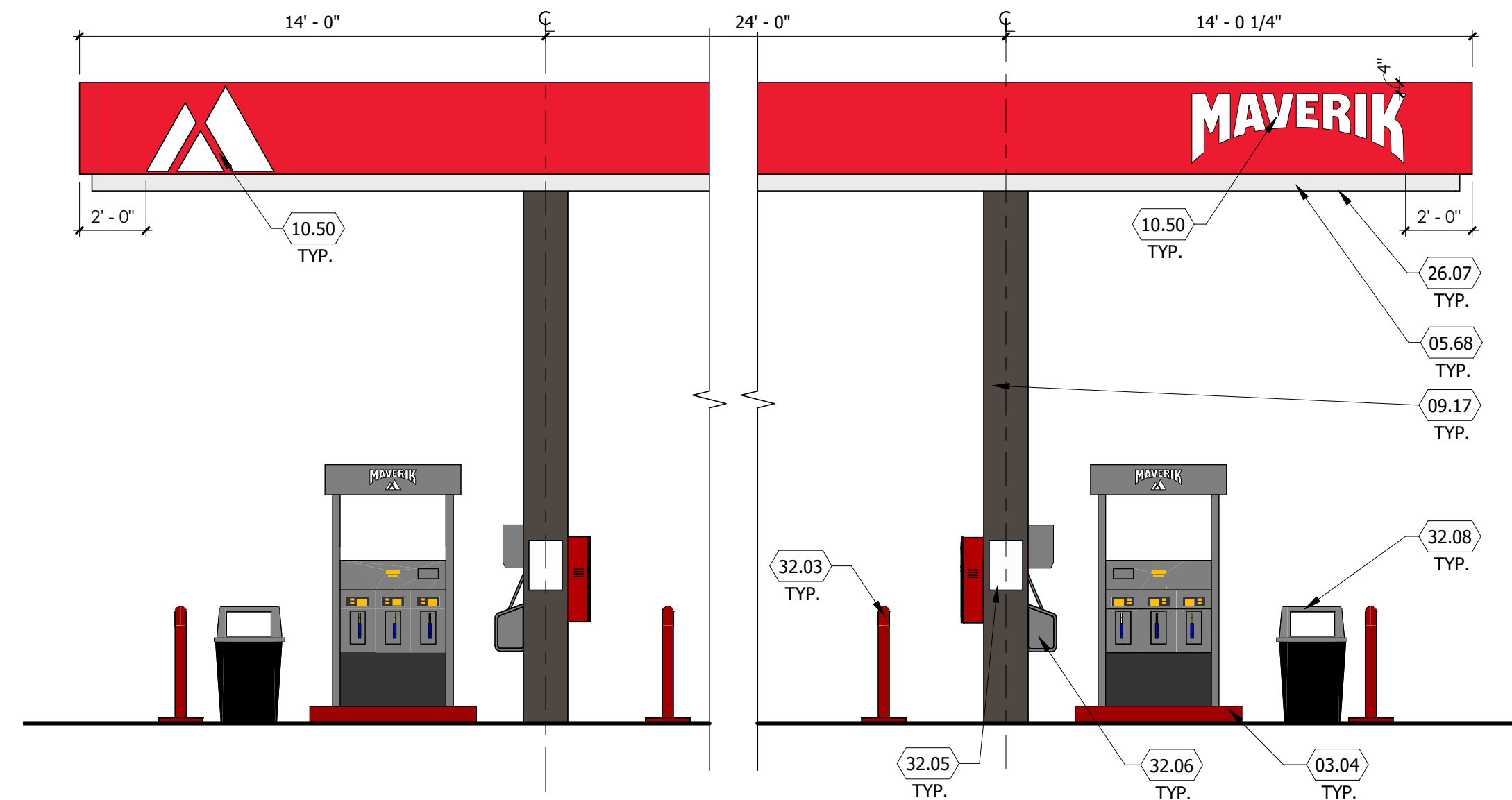

4 FUEL DISPENSING CANOPY - END ELEVATION
SCALE: 1/4" = 1'-0"

KEYED NOTES

- 03.04 REINFORCED CONCRETE PAD
- 03.10 6" MIN. RAISED CONCRETE ISLAND W/ TOOLED EDGES AND CORNERS. VERIFY SIZE W/ DISPENSER SUPPLIER +/- 5'-0" X 3'-0" (NO METAL FORM). ACCESSIBLE ISLAND TO BE 6"; SEE CIVIL DRAWINGS FOR LOCATION
- 05.12 ALUMINUM COMPOSITE METAL PANEL, EASTMAN RED
- 05.68 ALUMINUM COMPOSITE METAL PANEL, WHITE
- 09.17 PANEL COLUMN CLADDING, COLOR TO MATCH P-9
- 10.49 4A-40 BC FIRE EXTINGUISHER W/ CASE, LOCATE WITHIN 75' OF ALL PUMPS, DISPENSERS, OR STORAGE TANK. LOCATION TO BE FINALIZED BY FIRE MARSHAL
- 10.50 SIGNAGE TO BE COORDINATED BY FUEL CANOPY CONTRACTOR WITH OWNER
- 26.07 ALL LIGHT FIXTURES (NOT SHOWN) TO BE FLUSH MOUNTED WITHIN THE DECK PANEL SOFFIT (SOFFIT COLOR P-7). SEE ELECTRICAL AND FUEL DISPENSING DRAWINGS
- 32.03 4" DIAMETER "U" BOLLARD, SET AND FILLED W/ CONCRETE, SEE CIVIL DRAWINGS PAINTED P-4
- 32.04 EXPANSION JOINTS, TO BE FILLED W/ "JET FUEL RESISTANT" SEALANT, SEE CIVIL DRAWINGS
- 32.05 SIGNAGE, BY OWNER, TO COMPLY WITH IFC 2305.6 AND POSTED ON EACH SIDE OF COLUMN
- 32.06 S.S.I. (WINDOW WASH/PAPER TOWEL) PROVIDED BY OWNER INSTALLED BY CONTRACTOR, MOUNTED TO COLUMN PER ADA REQUIREMENTS (4'-0" MAX A.F.F. TO PAPER TOWEL FOLD)
- 32.08 TRASH CONTAINER, PROVIDED BY OWNER
- 32.09 PAINT CONCRETE CURB EDGE P-4, SEE SCHEDULE ON SHEET A6.03

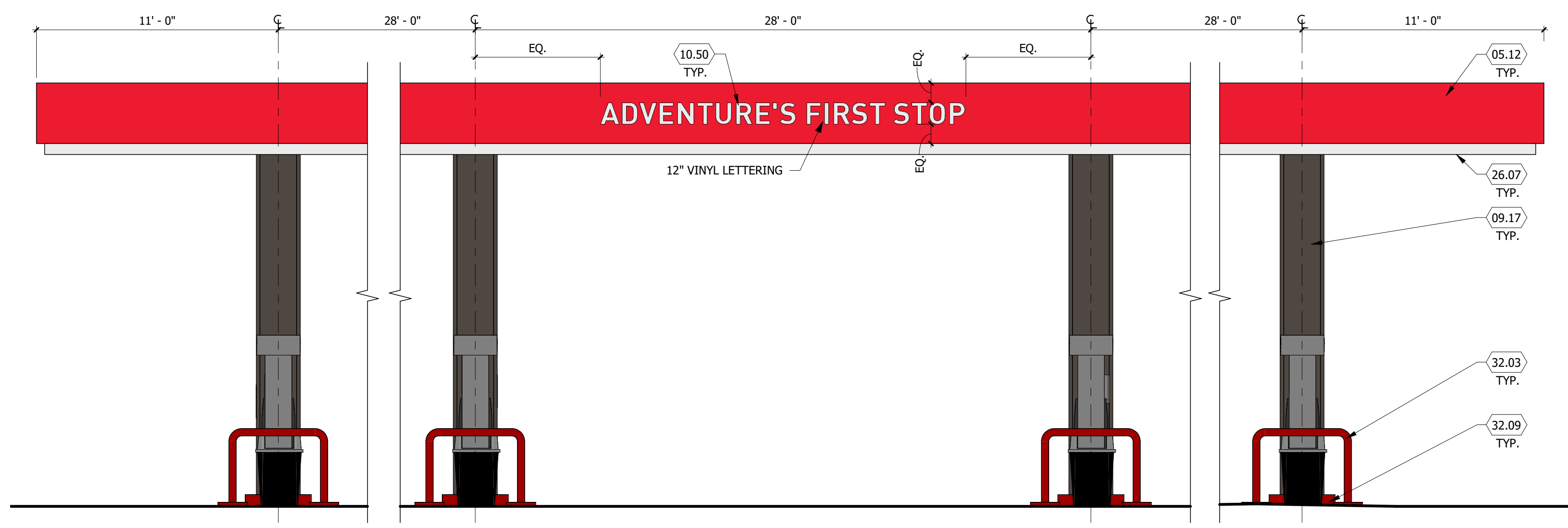

3 FUEL DISPENSING CANOPY - BUILDING SIDE ELEVATION
SCALE: 1/4" = 1'-0"

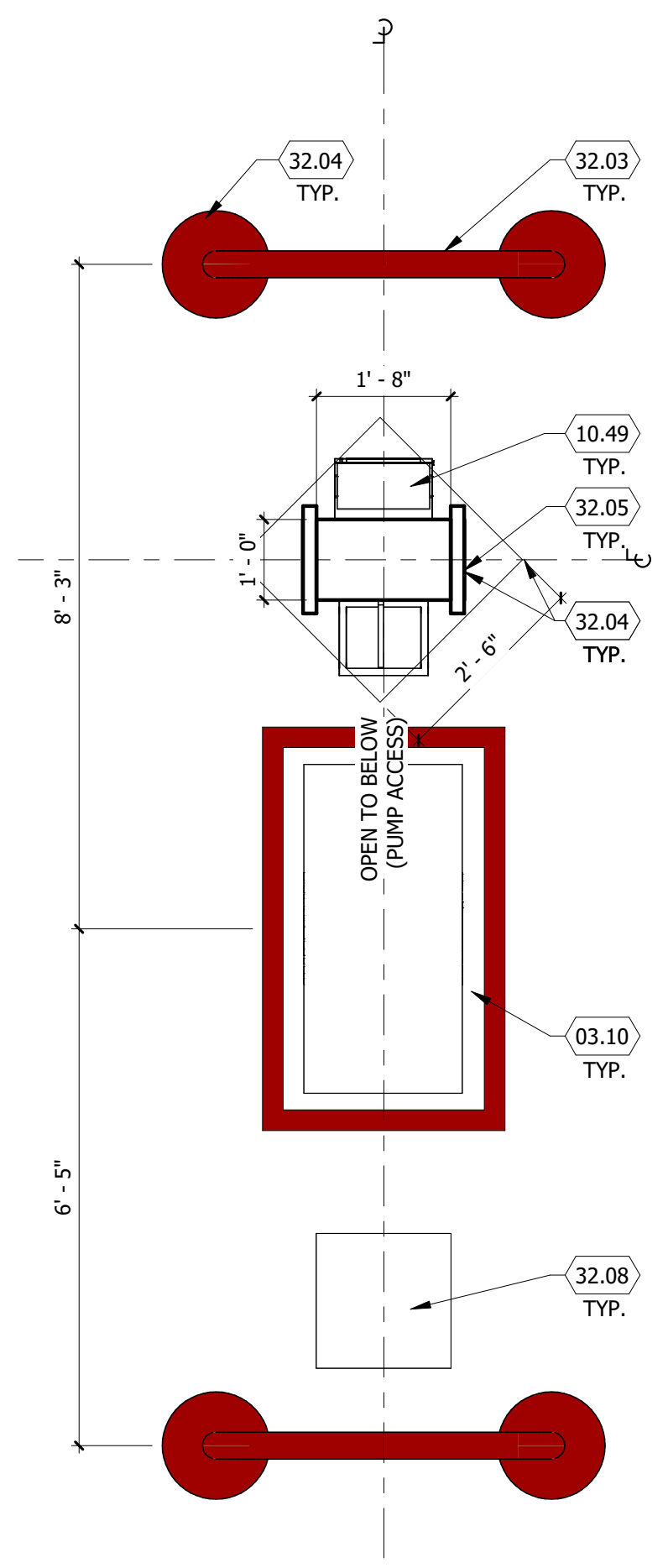

2 CANOPY COLUMN PLAN
SCALE: 1/2" = 1'-0"

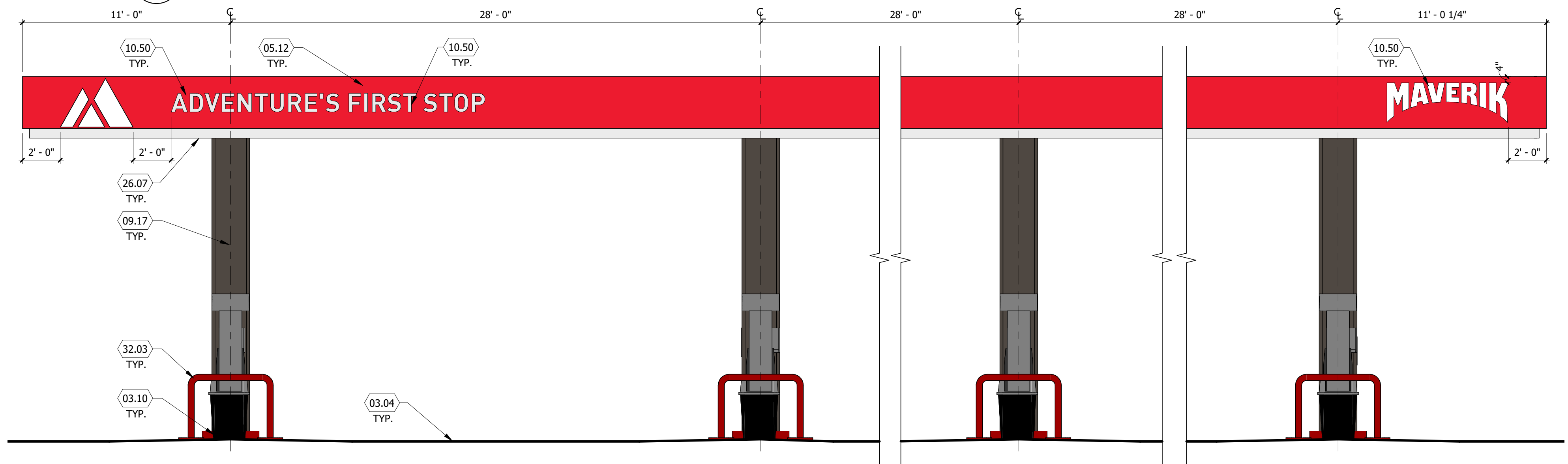

1 FUEL DISPENSING CANOPY - STREET SIDE ELEVATION
SCALE: 1/4" = 1'-0"

PROPOSED MAVERIK C-STORE

NOTE:
FUEL CANOPY DRAWINGS PROVIDED ARE CONCEPTUAL, AND MAY VARY FROM SITE TO SITE.

Prototype Version: 50_R_RR_2101
Building Square Footage: 5,637 SF
Construction Type/Occupancy Classification: V-B / M





BB-1 Fiberboard -
Worldly Gray

BB-2 Fiberboard -
Gauntlet Gray

BB-3 Fiberboard -
Worldly Gray



Cultured Stone - Skyline, Country LedgeStone



C-1 MBCI Midnight Bronze



C-2 MBCI Brite Red



Anodized - Dark Bronze



Paint - Black Fox

PROPOSED MAVERIK C-STORE

Prototype Version: 50_R_RR_2101
Building Square Footage: 5,637 SF
Construction Type/Occupancy Classification: V-B / M

A-7 | EXTERIOR MATERIALS BOARD