



Town of Parker Community Development Department
 Development Review Division
 Attention: **Amber Wood Hicken**

Application Type: **Site Plan**
 Status: **First Referral**
 Application Name: Parker Pointe F1 L13 - McDonald's Site Plan
 Case/AP#: **SP22-089**
 Referral Received: November 2, 2022
 Comments Due: December 5, 2020

Application Location: Generally located at the southeast corner of Parker Road and Stroh Road

Review date: **November 22, 2022**
 Plan reviewer: **Randall L. Capra, rcapra@parkeronline.org**
 Phone: 303.805.3163

Narrative: The applicant, McDonald's USA, LLC, is proposing a Site Plan for the construction of a 4,795 square foot McDonald's restaurant. The site is located at the southeast corner of Parker Road and Stroh Road.

Code Reference: 2021 International Fire Code, 2021 International Building Code, 2020 NEC

TOWN OF PARKER FIRE/LIFE SAFETY:	R REVIEWED FOR CODE COMPLIANCE; REVISIONS REQUIRED
---	---

- 1st Submittal – Reviewed November 22, 2022
- 2nd Submittal – Reviewed (*Comments in red, italicized font*)

UNRESOLVED ISSUES/COMMENTS

The items noted below with a comment number (1, 2 etc.) are items that need to be corrected to show compliance with the applicable codes. Please provide a written response to this letter indicating where the corrections are made on the plans (cloud the plans as applicable). This will speed up the second review process.

1. The applicant shall be aware that **no vertical construction on this site will be allowed until such time that curb gutter and first lift of asphalt are installed**; a site inspection will be required to ensure that this requirement is made prior to allowing vertical construction to commence.
2. The proposed fire hydrant shall be relocated to the west; see this location below and adjust when resubmitting:

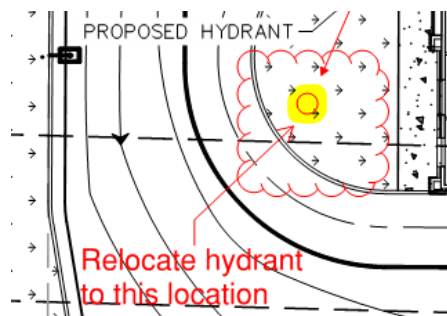

3. The applicant has not provided the required over-all utility plan set; when resubmitting, ensure that the Fire Life Safety signature block is provided on both the cover sheet and the over-all utility sheet. Address this issue when resubmitting.

4. The overall utility plan set shall call out the UFL by name while identifying the length, as measured from the “T” at the water main to the flange in the riser room. The diameter of this pipe shall also be shown as a notation on the fire line. This requirement is not negated should the applicant note length and diameter as a note in a side table. Address this issue when resubmitting.
5. The riser room shall be sized to accommodate the following:
 - *The underground fire line is not allowed to have domestic tapped off of it*
 - *The sprinkler riser is allowed to enter no further than 24-inches into the building (and any less than 12-inches into the building).*
 - *A three-foot clearance shall be provided in front of the riser (with 18” of clearance on either side of the riser).*
 - *The fire alarm control panel (FACP) is required to be located on an interior wall.*
 - *A three-foot clearance is required in front of the FACP.*
 - *Exterior access is required to be provided into the riser room; this access shall be approved.*
 - *Access into the building shall be provided through the riser room or immediately adjacent to the riser room.*
 - *While domestic water can be located in the riser room, the domestic cannot be located in any way that conflicts with the access requirements for both the FACP and the sprinkler riser.*
 - *A sidewalk is required to the riser room and a 5 x 5 pad is required in front of the FDC.*

The applicant shall **provide a floor plan of how the riser room is to be laid** out to avoid conflicts with the site plan once the building review submittal has been made; this project will not be approved without this requirement having been met and approved.

6. The applicant shall provide an auto turn analysis indicating that apparatus can navigate all portions of this site; NO PARKING – FIRE LANE signage is required for any portion of the access where the 20-foot clear width requirement cannot be met. In this case, the applicant has provided an auto turn analysis for a portion of the site; the applicant shall update the analysis to include the right in/right out entry on the south portion of the site; see below and address when resubmitting:

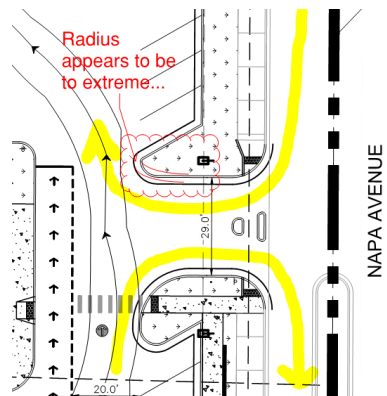

7. The applicant shall provide NO PARKING – FIRE LANE signage for any portion of the access where the 24-foot clear width requirement cannot be met; areas that are required to have this signage are located on both the north and sides of the building. See below for areas highlighted in yellow:

Note - The Town of Parker requires that fire apparatus access roads meet the clear-width and weight-bearing standards of the jurisdiction in which the project is located. Roadways shall be designed to support the imposed weight of fire apparatus, 30-ton, two axle and 40-ton, three axle vehicles. An unimpeded clear width of 24-feet shall be maintained at all times. As such, any location where parked vehicles would obstruct this clear width requirement will require “NO PARKING – FIRE LANE” signage. *This signage shall be red on white. Design criteria has been provided at the end of this document; ensure compliance when resubmitting.*

GENERAL COMMENTS (as applicable)

All engineering documents submitted to the Town of Parker shall bear the wet signature and seal of the engineer or architect in responsible charge of the design.

Water distribution and site access components shall be installed and in service prior to the construction of any portion of the structure, except by special permit issued by the Fire District.

Underground fire lines

When thrust blocks are used as part of the pipe restraint system, submitted plans for permit shall provide detailed documentation that the thrust blocks satisfy all requirements of 19 NFPA 24: 10.8.2, including specific thrust block dimensions and mathematical calculations for block dimensions per guidelines provided in Annex A.10.8.2.

FIRE ACCESS ROAD DESIGN CRITERIA

VEHICLE SPECIFICATIONS are provided for the largest apparatus in use by South Metro Fire Rescue. Fire Apparatus Access Roads shall be capable of accommodating this apparatus.

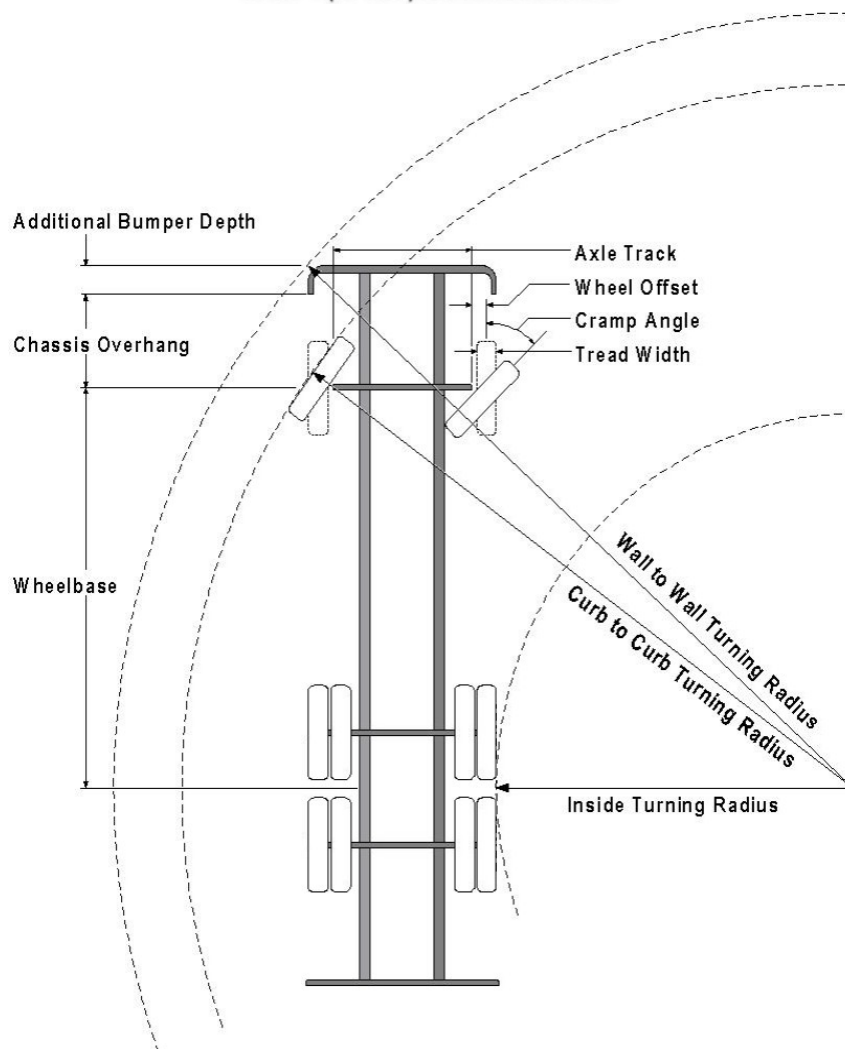
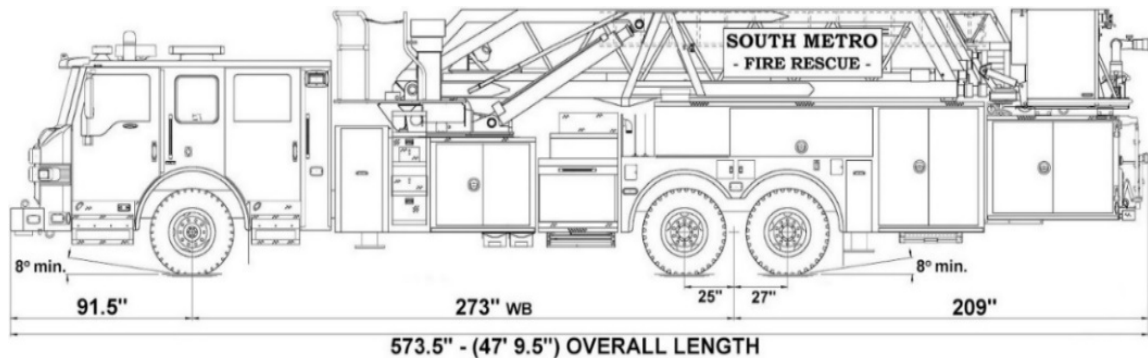

Vehicle Specifications

Length: 47' 9.5"

Width: 8' 5" - (10' 1" mirror to mirror)

Height: 10' 9"

Wheelbase: 273 in.

Design load: 80,000 pounds

Inside Cramp Angle: 40°

Axle Track: 83"

Wheel Offset: 5.3"

Tread Width: 13.5"

Turning Radii:

Inside Turn: 26 ft. 1 in.

Curb to curb: 41 ft. 11 in.

Wall to wall: 46 ft. 8 in.

Where objects are present adjacent to the fire apparatus access road, particularly on turns and turn arounds which require backing, a reasonable safety margin shall be provided to prevent potential damage to the property and to the fire apparatus.

PRIVATE ROADS that provide access to more than two dwellings or one or more commercial buildings shall be constructed to meet the roadway standards approved by the South Metro Fire Rescue Authority for fire apparatus access. Private roads that do not meet the roadway standard may be accepted provided that alternative methods and materials are incorporated into the subdivision that addresses the fire and life safety of the citizens.

Posting of Fire Lanes: The posting of the "Fire Lanes" is required.

Fire Lane Sign Dimensions. NO PARKING – FIRE LANE signs shall be 12 inches wide and 18 inches high.

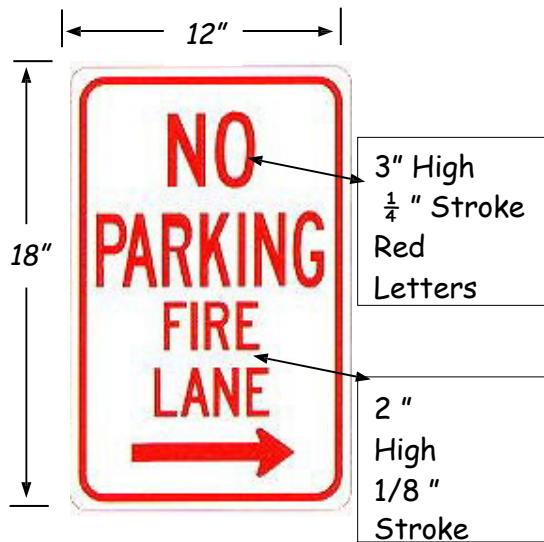

Fire Lane Sign Characteristics: Signs shall be engineer grade reflective sheeting on 0.80 aluminum with red lettering on a white background.

Fire Lane Sign Locations. Fire apparatus access roadways between 20 and 28 feet wide, signs shall be posted on *both sides*. Fire apparatus access roadways between 28 feet wide and 34 feet wide, signs may be posted on *one side only*.

Fire Lane Sign Installation. NO PARKING – FIRE LANE signs shall be installed as follows:

1. Bottom edge of the signs shall be 7 feet above surface (sidewalk) and post shall be placed 24 inches from flow line (curb).
2. One sign at the beginning of the restriction (one arrow pointing towards the restriction zone).
3. One sign at the end of the restriction (one arrow pointing back into restricted zone).
4. One sign at least every 150 ft. within the restricted area (double arrow pointing in each direction, to indicate the continuing restriction).
5. Spaced evenly within the restriction (for straight curbs/zones). For example, if the parking restriction zone is 300 ft long, only one double arrow sign is required at a distance of 150 ft. from the beginning of the restriction. If the restriction zone is 400 ft. long, two double arrow signs are required; spaced 100 ft. evenly from each other and from the beginning/ending signs.
6. Spaced so that at least one readable sign is visible in front of a parked vehicle from any point along the restriction (for curved curbs/zones and areas that may present visual obstacles.)
7. Set at an angle of no fewer than 30 degrees and no more than 45 degrees with the lane of traffic flow visible to approaching traffic.
8. Signs shall be provided at all normal and emergency access points to structures and within 20 feet of each fire hydrant and fire department connection (FDC) in compliance with UFC 901.4.2.
9. Some areas may need additional fire lane signs. Check with the Division of Life Safety for any additional requirements.

Fire Lane Sign Types. The diagrams below indicate the types of signs that may be used, and the recommended placement.

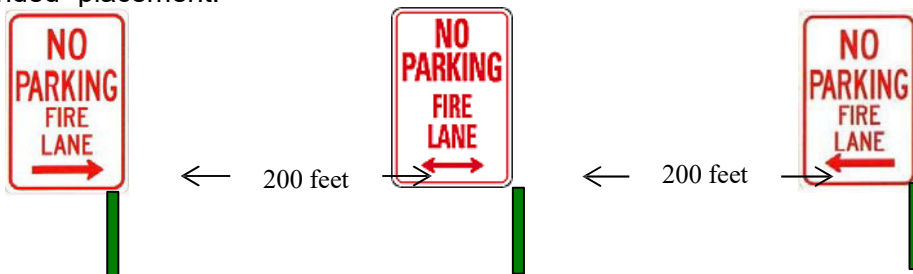

Additional sign styles may be used – provided the same type is used consistently.

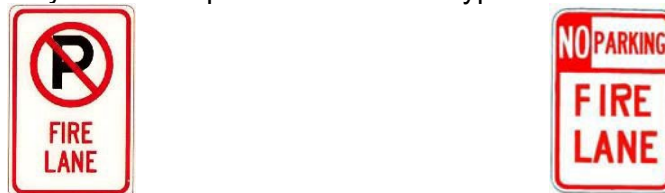

Painting of Curbs or Streets. In addition to the required signage, South Metro Fire Rescue does permit fire lanes to be painted with curb or street markings. However, these markings shall not replace the required fire lane signs. Curbs may be painted red with 3-inch white block letters stating **NO PARKING – FIRE LANE**. Lettering shall be spaced every 15 feet.

Underground Fire Line - Submittal Requirements

Reference: 2019 NFPA 24 [Installation of Private Fire Service Mains and Their Appurtenances](#)

A separate permit is required and will be issued pending review of a detailed submittal which must include the following:
[21 IFC 901.2]

4.1.1 Working plans shall be submitted for approval to the authority having jurisdiction before any equipment is installed or replaced.

4.1.2 Deviation from approved plans shall require permission of the authority having jurisdiction.

4.1.3 Working plans shall be drawn to an indicated scale on sheets of uniform size, with a plan of each floor as applicable, and shall include the following items that pertain to the design of the system:

- (1) Name of owner
- (2) Location, including street address
- (3) Point of compass
- (4) A graphic representation of the scale used on all plans
- (5) Name and address of contractor
- (6) Size and location of all water supplies
- (7) The following items that pertain to private fire service mains:
 - (a) Size
 - (b) Length
 - (c) Location
 - (d) Material (ductile-iron, PVC., etc.)
 - (e) Point of connection to city main
 - (f) Sizes, types, and locations of valves, depth at which the top of the pipe is laid below grade
 - (g) Method of restraint (Meg-a-Lug or similar)

4.1.4 The working plan submittal shall include the manufacturer's installation instructions for any specially listed equipment, including descriptions, applications, and limitations for any devices, piping, or fittings. Submittals must include installation specifications for thrust blocks, corrosion protection, restraint system, bedding, detail of pipe under the building up to, and including, the flange. When it is intended that a different contractor will extend the fire line from a stopping point outside the building, to the inside flange, a second submittal and permit is required.

All tees, plugs, reducers, valves, and hydrant branches shall be restrained against movement by thrust blocks [10.8.2] or restrained joint systems [10.8.3]. When thrust blocks are used as part of the pipe restraint system, submitted plans shall provide detailed documentation that the thrust blocks satisfy all requirements of Section 10.8.2, including specific thrust block dimensions and mathematical calculations for block dimensions per guidelines provided in Annex A.10.8.2.

Any individual or company who physically works on or installs any part of a fire suppression system, including underground supply lines, from public water lines to system risers and backflow preventers, **must** be registered with the Colorado Division of Fire Safety. [Dept of Public Safety, Division of Fire Safety, Fire Suppression Program 8 CCR 1507-11:3.1.2] Documentation of valid annual registration may be required with plan submittal.

The following website for the Colorado Division of Fire Safety will provide registration instructions.

<http://dfs.state.co.us/SuppAppsProclnsp.htm>

All submittals must display a wet stamp and original signature by a Colorado licensed professional engineer or NICET III, or higher, in fire suppression systems. [Dept. of Public Safety, Division of Fire Safety, Fire Suppression Program 8 CCR 1507

FIRE CODE REVIEW BLOCK

All fire hydrants shall be installed according to water utility standards. The number and locations of the fire hydrants as shown on the Overall Utility Plan are correct as specified by the Town of Parker, Community Development Department.

Fire Code Official or Designated Representative

Date

(NOTE - Underground Fire Line (UFL) submittal documents must meet the requirements of NFPA 24 when submitting for review.)