

1889 York Street
Denver, CO 80206
(303) 333-1105
FAX (303) 333-1107
E-mail: lsc@lscdenver.com



January 25, 2018

Mr. Corey Elliott
HR 935, LLC
7353 S. Alton Way, Suite A-100
Englewood, CO 80112

Re: Trails at Crowfoot
Traffic Impact Analysis
Parker, CO
LSC #160711

Dear Mr. Elliott:

In response to your request, LSC Transportation Consultants, Inc. has prepared this updated traffic impact analysis for the Trails at Crowfoot development to address Town of Parker comments. As shown on Figure 1, the site is located southeast of Crowfoot Valley Road and east and west of the future Bayou Gulch Road alignment in Parker, Colorado.

REPORT CONTENTS

The report contains the following: the existing roadway and traffic conditions in the vicinity of the site including the lane geometries, traffic controls, posted speed limits, etc.; the existing weekday peak-hour traffic volumes; the existing daily traffic volumes in the area; the typical weekday site-generated traffic volume projections for the site; the assignment of the projected traffic volumes to the area roadways; the projected short-term and long-term background and resulting total traffic volumes on the area roadways; the site's projected traffic impacts; and any recommended roadway improvements to mitigate the site's traffic impacts.

LAND USE AND ACCESS

The site is proposed to include about 754 single-family residential dwelling units, about 136 duplex residential dwelling units, and about 40,000 square feet of commercial space. Access is proposed to North Pinery Parkway and Bayou Gulch Road at multiple locations as shown in the conceptual site plan in Figure 2.

ROADWAY AND TRAFFIC CONDITIONS

Area Roadways

The major roadways in the site's vicinity are shown on Figure 1 and are described below.

- **N. Crowfoot Valley Road** is a north-south, two-lane arterial roadway west of the site. The intersection with Stroh Road is signalized with auxiliary turn lanes. North of Stroh Road it changes names to Motsenbocker Road and is four lanes. By 2037 it is expected to be a four-lane arterial roadway. The posted speed limit in the vicinity of the site is 40 mph.
- **Stroh Road** is an east-west, arterial roadway north of the site. The intersections with N. Crowfoot Valley Road/Motsenbocker Road and Parker Road are signalized with auxiliary turn lanes. It is two lanes west of J. Morgan Boulevard and four lanes east of J. Morgan Boulevard. By 2037 it is expected to be a four-lane arterial between N. Crowfoot Valley Road and Parker Road. The posted speed limit in the vicinity of the site is 40 mph.
- **N. Pinery Parkway** is a future east-west, two-lane roadway that will be constructed through the site from Crowfoot Valley Road to Parker Road. The existing intersection with Parker Road (SH 83) is signalized with auxiliary turn lanes. The posted speed limit east of the site is 25 mph. The buildout posted speed limit is expected to be 35 mph.
- **Bayou Gulch Road** is a future north-south, four-lane arterial roadway that will be constructed through the site from Crowfoot Valley Road to the south. By 2037 it is expected to be extended north to the existing Chambers Road alignment. The posted speed limit south of the site is 30 mph. The buildout posted speed limit is expected to be 40 mph.

Existing Traffic Conditions

Figure 3 shows the existing lane geometries, traffic controls, posted speed limits, and traffic volumes in the site's vicinity on a typical weekday. The weekday peak-hour traffic volumes and daily traffic counts are from the attached traffic counts conducted by Counter Measures in May, 2017.

2025 and 2037 Background Traffic

Figures 4a and 4b show the estimated 2025 background traffic, lane geometry, and traffic control and Figures 5a and 5b show the estimated 2037 background traffic, lane geometry, and traffic control. The 2025 estimates are based on projections from the April, 2013 *Town of Parker Roadway System Evaluation* by FHU and the 2037 estimates are based on the projections from the June, 2015 *Hess Ranch TIA* by David Evans and Associates. The 2037 estimates also assume a 750-student K-8 public school east of Bayou Gulch Road to the north of the site.

Existing, 2025, and 2037 Background Levels of Service

Level of service (LOS) is a quantitative measure of the level of congestion or delay at an intersection. Level of service is indicated on a scale from "A" to "F." LOS A is indicative of little congestion or delay and LOS F is indicative of a high level of congestion or delay. Attached are specific level of service definitions for signalized and unsignalized intersections.

The intersections in Figures 3, 4a, 4b, 5a, and 5b were analyzed as appropriate to determine the existing, 2025, and 2037 background levels of service using Synchro. Table 1 shows the level of service analysis results. The level of service reports are attached.

- **Stroh Road/Crowfoot Valley Road/Motsenbocker Road:** This signalized intersection currently operates at LOS “B” during both morning and afternoon peak-hour and is expected to do so through 2025. In 2037, both peak-hours are expected to operate at LOS “C”.
- **Crowfoot Valley Road/Chambers Road/Bayou Gulch Road:** All movements at this future unsignalized intersection are expected to operate at LOS “A” during both peak-hours in 2025. In 2037, this intersection is expected to be signalized and as such is expected to operate at LOS “D” in the morning peak-hour and LOS “E” during the afternoon peak-hour.
- **Crowfoot Valley Road/Pinery Parkway:** All movements at this future unsignalized intersection are expected to operate at LOS “C” or better during both peak-hours through 2025. In 2037, this intersection is expected to be signalized and as such is expected to operate at LOS “A” during both peak-hours.
- **Crowfoot Valley Road/Pradera Parkway:** All movements at this unsignalized intersection currently operate at LOS “B” or better during both peak-hours and are expected to operate at LOS “C” or better through 2025. In 2037, this intersection is expected to be signalized and as such is expected to operate at LOS “B” or better during both peak-hours.
- **Parker Road/Pinery Parkway:** This signalized intersection currently operates at LOS “C” during both morning and afternoon peak-hours. In 2025, the morning peak-hour is expected to operate at LOS “D” and the afternoon peak-hour is expected to operate at LOS “C” and is expected to do so through 2037.
- **Pinery Parkway/Bayou Gulch Road:** All movements at this future unsignalized intersection are expected to operate at “B” or better in 2025. In 2037, this intersection is expected to be signalized and as such is expected to operate at LOS “C” during both peak-hours.
- **Pinery Parkway/PA 46:** All movements at this future unsignalized intersection are expected to operate at LOS “B” or better through 2037.

TRIP GENERATION

Table 2 shows the estimated average weekday, morning peak-hour, and afternoon peak-hour trip generation for the proposed site based on the rates from *Trip Generation, 9th Edition, 2012* by the Institute of Transportation Engineers (ITE) for the proposed land use.

The site is projected to generate about 11,712 one-way vehicle-trips on the average weekday, with about half entering and half exiting during a 24-hour period. During the morning peak-hour, which generally occurs for one hour between 6:30 and 8:30 a.m., about 206 vehicles would enter and about 507 vehicles would exit the site. During the afternoon peak-hour, which generally occurs for one hour between 4:00 and 6:00 p.m., about 677 vehicles would enter and about 473 vehicles would exit.

TRIP DISTRIBUTION

Figure 6 shows the estimated directional distribution of the site-generated traffic volumes on the area roadways. The estimates were based on the location of the site with respect to the regional population, employment, and activity centers; and the site's proposed land use.

TRIP ASSIGNMENT

Figures 7a, 7b, 8a, and 8b show the estimated 2025 and 2037 site-generated traffic volumes based on the directional distribution percentages (from Figure 6) and the trip generation estimate (from Table 2).

2025 AND 2037 TOTAL TRAFFIC

Figures 9a and 9b show the 2025 total traffic which is the sum of the 2025 background traffic volumes (from Figures 4a and 4b) and the 2025 site-generated traffic volumes (from Figures 7a and 7b). Figures 9a and 9b also show the recommended 2025 lane geometry and traffic control with specific turn lane dimensions given in Table 3.

Figures 10a and 10b show the 2037 total traffic which is the sum of 2037 background traffic volumes (from Figures 5a and 5b) and the 2037 site-generated traffic volumes (from Figures 8a and 8b). Figures 10a and 10b also show the recommended 2037 lane geometry and traffic control.

PROJECTED LEVELS OF SERVICE

The intersections in Figures 9a, 9b, 10a, and 10b were analyzed to determine the 2025 and 2037 total levels of service. Table 1 shows the level of service analysis results. The level of service reports are attached.

- **Stroh Road/Crowfoot Valley Road/Motsenbocker Road:** This signalized intersection is expected to operate at LOS "C" or better during both morning and afternoon peak-hour through 2025. In 2037, the morning peak-hour is expected to operate at LOS "C" and the afternoon peak-hour is expected to operate at LOS "D".
- **Crowfoot Valley Road/Chambers Road/Bayou Gulch Road:** All movements at this future unsignalized intersection are expected to operate at LOS "D" or better during both peak-hours in 2025. In 2037, this intersection is expected to be signalized and as such is expected to operate at LOS "D" during the morning peak-hour and LOS "E" during the afternoon peak-hour. The LOS "E" can be improved by providing a free right-turn movement from eastbound Chambers Road to southbound Crowfoot Valley Road.
- **Crowfoot Valley Road/Pinery Parkway:** All movements at future this unsignalized intersection are expected to operate at LOS "D" or better during both peak-hours through 2025. In 2037, this intersection is expected to be signalized and as such is expected to operate at LOS "A" during the morning peak-hour and LOS "B" during the afternoon peak-hour.
- **Crowfoot Valley Road/Pradera Parkway:** All movements at this unsignalized intersection are expected to operate at LOS "C" or better through 2025. In 2037, this intersection is ex-

pected to be signalized and as such is expected to operate at LOS “B” during the morning peak-hour and LOS “A” during the afternoon peak-hour.

- **Parker Road/Pinery Parkway:** This signalized intersection is expected to operate at LOS “D” or better during both morning and afternoon peak-hours through 2037.
- **Pinery Parkway/Bayou Gulch Road:** All movements at this future unsignalized intersection are expected to operate at “C” or better in 2025 during both peak-hours. In 2037, this intersection is expected to be signalized and as such is expected to operate at LOS “D” or better during both peak-hours.
- **Bayou Gulch Road/RIRO South Access:** All movements at this future unsignalized intersection are expected to operate at LOS “A” in 2025 during both peak-hours. In 2037, all movements are expected to operate at LOS “B” or better during both peak-hours.
- **Pinery Parkway/PA 40 West/PA 34 West:** All movements at this future unsignalized intersection are expected to operate at LOS “C” or better during both peak-hours through 2037.
- **Pinery Parkway/PA 40 East/PA 34:** All movements at this future unsignalized intersection are expected to operate at LOS “B” or better through 2037.
- **Pinery Parkway/Three-Quarter Access:** All movements at this future unsignalized intersection are expected to operate at LOS “B” or better through 2037.
- **Pinery Parkway/PA 46:** All movements at this future unsignalized intersection are expected to operate at LOS “D” or better through 2037.
- **Bayou Gulch Road/PA 36&37/PA 34&35:** All movements at this future unsignalized intersection are expected to operate at LOS “C” or better through 2025. In 2037, there are several side street movements that are expected to operate at LOS “F” during both peak-hours. Traffic signal control may be needed in the long term.

CONCLUSIONS AND RECOMMENDATIONS

Trip Generation

1. The site is projected to generate about 11,712 one-way vehicle-trips on the average week-day, with about half entering and half exiting during a 24-hour period. During the morning peak-hour, about 206 vehicles would enter and 507 vehicles would exit the site. During the afternoon peak-hour, about 677 vehicles would enter and about 473 vehicles would exit.

Projected Levels of Service

2. All of the signalized intersections are expected to operate at overall LOS “D” or better with all individual movements operating at LOS “E” or better through 2037 during both peak-hours with the following exceptions: The Crowfoot Valley Road/ Chambers Road/Bayou Gulch Road intersection is expected to operate at LOS “E” and the eastbound right-turn

movement is expected to operate at LOS "F" in the 2037 afternoon peak-hour. Overall operations would improve if a free movement is provided for the eastbound right-turn movement from eastbound Chambers Road to southbound Crowfoot Valley Road. The westbound through/right movement from Pinery Parkway to Parker Road is expected to operate poorly without a dedicated right-turn lane and receiving acceleration lane on Parker Road.

- 3. All movements at the unsignalized intersections analyzed are expected to operate at LOS "D" or better during both morning and afternoon peak-hours through 2037 with the following exceptions: There are a few eastbound and westbound movements at the Bayou Gulch Road/PA 36&37/PA 34&35 intersection that are expected to operate at LOS "F" during the peak-hours by 2037. A traffic signal may be needed at this location in the long term.

Conclusions

- 4. The impact of the Trail at Crowfoot development site can be accommodated by the existing and planned roadway network with the following recommendations.

Recommended Improvements

- 5. The recommended 2025 improvements are shown in Figures 9a and 9b with specific turn lane dimensions given in Table 3.
- 6. The recommended 2037 improvements are shown in Figures 10a and 10b.

* * * * *

We trust our findings will assist you in gaining approval of the proposed Trails at Crowfoot residential development. Please contact me if you have any questions or need further assistance.

Sincerely,

LSC TRANSPORTATION CONSULTANTS, INC.

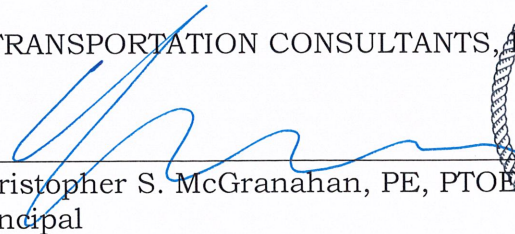
By 
Christopher S. McGranahan, PE, PTOE
Principal

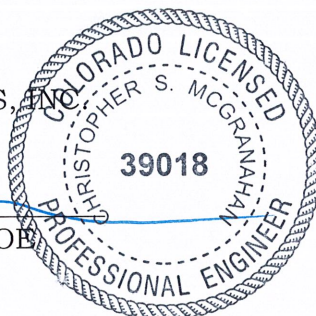

1-25-18

CSM/wc

- Enclosures:
- Tables 1 - 3
 - Figures 1 - 10b
 - Traffic Count Reports
 - Level of Service Definitions
 - Level of Service Reports

Table 1 (Page 1 of 2)
Intersection Levels of Service Analysis
Trails at Crowfoot
Parker, CO
LSC #160711; January, 2018

Intersection Location	Traffic Control	Existing Traffic		2025 Background Traffic		2025 Total Traffic		2037 Background Traffic		2037 Total Traffic	
		Level of Service	Level of Service	Level of Service	Level of Service	Level of Service	Level of Service	Level of Service	Level of Service	Level of Service	Level of Service
		AM	PM	AM	PM	AM	PM	AM	PM	AM	PM
1) Stroh Road/Crowfoot Valley Road/Motsenbocker Road											
	Signalized										
EB Left		--	--	--	--	--	--	D	D	D	D
EB Through		--	--	--	--	--	--	D	E	D	E
EB Right		--	--	--	--	--	--	D	D	D	D
WB Left		C	C	C	C	C	C	D	E	D	E
WB Through		--	--	--	--	--	--	C	C	C	C
WB Right		C	C	C	C	C	C	C	C	C	C
NB Left		--	--	--	--	--	--	E	E	E	E
NB Through		A	A	B	B	D	B	C	C	C	C
NB Right		A	A	B	B	B	B	C	C	C	C
SB Left		A	A	A	B	B	C	B	E	B	E
SB Through		A	A	A	A	A	A	B	D	B	D
SB Right		--	--	--	--	--	--	B	D	B	D
Entire Intersection Delay (sec /veh)		15.7	12.9	17.2	13.7	25.4	15.8	34.6	43.8	34.1	44.5
Entire Intersection LOS		B	B	B	B	C	B	C	C	C	D
2) Crowfoot Valley Road/Chambers Road/Bayou Gulch Road											
	TWSC										
WB Left		--	--	A	A	C	D	--	--	--	--
WB Right		--	--	A	A	D	C	--	--	--	--
SB Left		--	--	A	A	A	B	--	--	--	--
Critical Movement Delay		--	--	8.8	8.6	34.3	30.8	--	--	--	--
	Signalized										
EB Left		--	--	--	--	--	--	E	E	E	E
EB Through		--	--	--	--	--	--	D	D	D	D
EB Right		--	--	--	--	--	--	C	F	C	F
WB Left		--	--	--	--	--	--	E	E	E	E
WB Through		--	--	--	--	--	--	E	E	E	E
WB Right		--	--	--	--	--	--	A	A	A	A
NB Left		--	--	--	--	--	--	D	D	D	D
NB Through		--	--	--	--	--	--	B	C	B	C
NB Right		--	--	--	--	--	--	B	B	B	C
SB Left		--	--	--	--	--	--	E	E	E	E
SB Through		--	--	--	--	--	--	D	E	D	E
SB Right		--	--	--	--	--	--	D	D	D	D
Entire Intersection Delay (sec /veh)		--	--	--	--	--	--	40.5	60.4	43.2	66.6
Entire Intersection LOS		--	--	--	--	--	--	D	E	D	E
3) Crowfoot Valley Road/Pinery Parkway											
	TWSC										
WB Left		--	--	C	C	D	D	--	--	--	--
WB Right		--	--	A	A	A	A	--	--	--	--
SB Left		--	--	A	A	A	A	--	--	--	--
Critical Movement Delay		--	--	17.8	16.1	27.3	25.5	--	--	--	--
	Signalized										
WB Left		--	--	--	--	--	--	E	E	E	E
WB Right		--	--	--	--	--	--	A	A	A	A
NB Through		--	--	--	--	--	--	A	B	A	B
NB Right		--	--	--	--	--	--	A	A	A	A
SB Left		--	--	--	--	--	--	A	A	A	C
SB Through		--	--	--	--	--	--	A	A	A	A
Entire Intersection Delay (sec /veh)		--	--	--	--	--	--	4.9	7.6	7.5	10.8
Entire Intersection LOS		--	--	--	--	--	--	A	A	A	B
4) Crowfoot Valley Road/Pradera Parkway											
	TWSC										
WB Left		B	B	C	C	C	C	--	--	--	--
WB Right		B	B	B	B	B	B	--	--	--	--
SB Left		A	A	A	A	A	A	--	--	--	--
Critical Movement Delay		14.8	14.7	18.8	16.9	21.1	19.4	--	--	--	--
	Signalized										
WB Left		--	--	--	--	--	--	E	E	E	E
WB Right		--	--	--	--	--	--	E	D	E	D
NB Through		--	--	--	--	--	--	A	A	A	A
NB Right		--	--	--	--	--	--	A	A	A	A
SB Left		--	--	--	--	--	--	A	A	A	A
SB Through		--	--	--	--	--	--	A	A	A	A
Entire Intersection Delay (sec /veh)		--	--	--	--	--	--	11.3	8.0	11.3	8.3
Entire Intersection LOS		--	--	--	--	--	--	B	A	B	A
5) Parker Road/Pinery Parkway											
	Signalized										
EB Left		E	E	E	E	E	E	E	E	E	E
EB Through		C	D	D	D	D	D	D	D	D	D
EB Right		A	A	A	A	A	A	A	A	A	A
WB Left		C	D	C	D	C	D	C	D	C	D
WB Through/Right		E	F	F	F	F	F	F	E	F	E
NB Left		E	F	E	F	E	E	E	E	E	E
NB Through		C	B	C	B	C	C	C	C	C	C
NB Right		C	B	C	C	D	C	C	C	D	C
SB Left		E	D	E	D	E	D	E	E	E	E
SB Through		B	B	B	B	B	B	B	C	C	C
SB Right		A	A	A	A	A	A	A	A	A	A
Entire Intersection Delay (sec /veh)		33.8	27.5	45.0	31.0	46.4	33.5	48.4	31.9	51.4	34.5
Entire Intersection LOS		C	C	D	C	D	C	D	C	D	D

Table 1 (Page 2 of 2)
Intersection Levels of Service Analysis
Trails at Crowfoot
Parker, CO
LSC #160711; January, 2018

Intersection Location	Traffic Control	Existing Traffic		2025 Background Traffic		2025 Total Traffic		2037 Background Traffic		2037 Total Traffic	
		Level of Service	Level of Service	Level of Service	Level of Service	Level of Service	Level of Service	Level of Service	Level of Service	Level of Service	Level of Service
		AM	PM	AM	PM	AM	PM	AM	PM	AM	PM
6) <u>Pinery Parkway/Bayou Gulch Road</u>	TWSC	--	--	A	A	A	A	--	--	--	--
NB Left		--	--	A	A	B	C	--	--	--	--
EB Left		--	--	B	B	B	C	--	--	--	--
EB Through		--	--	A	A	A	A	--	--	--	--
EB Right		--	--	B	B	B	C	--	--	--	--
WB Left		--	--	B	B	B	C	--	--	--	--
WB Through		--	--	B	B	B	C	--	--	--	--
WB Right		--	--	A	A	A	A	--	--	--	--
SB Left		--	--	A	A	A	A	--	--	--	--
Critical Movement Delay		--	--	10.6	11.3	12.4	17.2	--	--	--	--
	Signalized	--	--	--	--	--	--	C	C	C	D
EB Left		--	--	--	--	--	--	C	C	C	D
EB Through		--	--	--	--	--	--	C	C	C	D
EB Right		--	--	--	--	--	--	C	C	C	D
WB Left		--	--	--	--	--	--	C	D	C	D
WB Through		--	--	--	--	--	--	D	D	C	D
WB Right		--	--	--	--	--	--	C	D	C	C
NB Left		--	--	--	--	--	--	B	B	C	B
NB Through		--	--	--	--	--	--	C	C	C	C
NB Right		--	--	--	--	--	--	B	B	C	B
SB Left		--	--	--	--	--	--	E	E	E	E
SB Through		--	--	--	--	--	--	C	C	D	C
SB Right		--	--	--	--	--	--	C	C	C	B
Entire Intersection Delay (sec /veh)		--	--	--	--	--	--	33.4	33.4	35.7	33.6
Entire Intersection LOS		--	--	--	--	--	--	C	C	D	C
7) <u>Bayou Gulch Road/RIRO South Access</u>	TWSC	--	--	--	--	A	A	--	--	B	B
EB Right		--	--	--	--	A	A	--	--	B	B
Critical Movement Delay		--	--	--	--	8.6	8.7	--	--	11.2	11.6
8) <u>Pinery Parkway/PA 40 West/PA 34 West</u>	TWSC	--	--	--	--	B	B	--	--	B	C
NB Approach		--	--	--	--	A	A	--	--	A	A
EB Left		--	--	--	--	A	A	--	--	A	A
WB Left		--	--	--	--	A	A	--	--	A	A
SB Approach		--	--	--	--	A	A	--	--	A	B
Critical Movement Delay		--	--	--	--	11.0	11.7	--	--	11.6	15.7
9) <u>Pinery Parkway/PA 40 East/PA 34</u>	TWSC	--	--	--	--	B	B	--	--	B	B
NB Approach		--	--	--	--	A	A	--	--	A	A
EB Left		--	--	--	--	A	A	--	--	A	A
WB Left		--	--	--	--	A	A	--	--	A	A
SB Approach		--	--	--	--	A	A	--	--	B	B
Critical Movement Delay		--	--	--	--	10.0	10.6	--	--	10.8	13.3
10) <u>Pinery Parkway/Three-Quarter Access</u>	TWSC	--	--	--	--	A	A	--	--	B	B
NB Right		--	--	--	--	A	A	--	--	A	A
EB Left		--	--	--	--	A	A	--	--	A	A
WB Left		--	--	--	--	A	A	--	--	A	A
SB Right		--	--	--	--	A	A	--	--	B	A
Critical Movement Delay		--	--	--	--	9.1	9.7	--	--	11.2	12.0
11) <u>Pinery Parkway/PA 46</u>	TWSC	--	--	A	A	B	B	B	B	C	D
NB Approach		--	--	--	--	A	A	--	--	A	A
EB Left		--	--	--	--	A	A	--	--	A	A
WB Left		--	--	A	A	A	A	A	A	A	A
SB Approach		--	--	--	--	B	B	--	--	C	C
Critical Movement Delay		--	--	8.9	9.1	10.6	14.9	13.7	13.7	22.6	33.5
12) <u>Bayou Gulch Road/PA 36&37/PA 34&35</u>	TWSC	--	--	--	--	A	A	--	--	B	B
NB Left		--	--	--	--	B	C	--	--	F	F
EB Left		--	--	--	--	A	A	--	--	F	F
EB Through/Right		--	--	--	--	B	B	--	--	F	F
WB Left		--	--	--	--	A	A	--	--	F	F
WB Through		--	--	--	--	A	A	--	--	C	C
WB Right		--	--	--	--	A	A	--	--	B	C
SB Left		--	--	--	--	A	A	--	--	B	C
Critical Movement Delay		--	--	--	--	11.3	15.1	--	--	>240	>240

Table 2
ESTIMATED TRAFFIC GENERATION
Trails At Crowfoot
Parker, CO
LSC #160711; January, 2018

PA	Trip Generating Category	Quantity	Trip Generation Rates ⁽¹⁾				Vehicle - Trips Generated					
			Average Weekday	AM Peak Hour In	AM Peak Hour Out	PM Peak Hour In	PM Peak Hour Out	Average Weekday	AM Peak Hour In	AM Peak Hour Out	PM Peak Hour In	PM Peak Hour Out
34	Single-Family Residential ⁽²⁾	199 DU ⁽³⁾	9.52	0.188	0.563	0.630	0.370	1,895	37	112	124	74
35	Duplex ⁽⁴⁾	48 DU	5.81	0.075	0.365	0.348	0.172	279	4	18	17	8
36	Duplex	44 DU	5.81	0.075	0.365	0.348	0.172	256	3	16	15	8
39	Single-Family Residential	189 DU	9.52	0.188	0.563	0.630	0.370	1,799	35	106	119	70
40	Single-Family Residential	166 DU	9.52	0.188	0.563	0.630	0.370	1,580	31	93	105	61
41	Single-Family Residential	31 DU	9.52	0.188	0.563	0.630	0.370	295	6	17	20	12
42	Single-Family Residential	100 DU	9.52	0.188	0.563	0.630	0.370	952	19	56	63	37
43	Duplex	44 DU	5.81	0.075	0.365	0.348	0.172	256	3	16	15	8
44	Shopping Center ⁽⁵⁾	40 KSF ⁽⁶⁾	93.58	1.375	0.850	3.900	4.225	3,743	55	34	156	169
46	Single-Family Residential	51 DU	9.52	0.188	0.563	0.630	0.370	486	10	29	32	19
47	Single-Family Residential	18 DU	9.52	0.188	0.563	0.630	0.370	171	3	10	11	7
890 DU							Total =	11,712	206	507	677	473
							Passby Trips ⁽⁷⁾ =	1,273	15	15	55	55
							Primary Trips =	10,439	191	492	622	418

Notes:

- (1) Source: *Trip Generation*, Institute of Transportation Engineers, 9th Edition, 2012
- (2) ITE Land Use No. 210 - Single-Family Detached Housing
- (3) DU = Dwelling Units
- (4) ITE Land Use No. 230 - Townhomes
- (5) ITE Land Use No. 820 - Shopping Center - formula rates
- (6) KSF = 1,000 square feet
- (7) A 34 percent passby rate was used for the shopping center land use.

Table 3
2025 Total Traffic Recommended Improvements
Trails at Crowfoot
Parker, CO
LSC #160711; January, 2018

Inter-section No.	Intersection	Recommended Improvements based on a 35 mph posted speed limit on Pinery Parkway and a 40 mph posted speed limit on other roadways	
2	<u>Crowfoot Valley Road/Bayou Gulch Road</u>	NB Right SB Left WB Left WB Right Accel	320-foot lane plus 180-foot transition taper ⁽¹⁾ 300-foot dual lane for vehicle storage, 225 feet for deceleration (one lane) plus a 12:1 transition taper 325-foot lane (225 feet for deceleration and 100 feet for vehicles storage) plus 145-foot transition taper - will be built as dual left to align with the opposing direction 580-foot lane plus 180-foot transition taper ⁽¹⁾
3	<u>Crowfoot Valley Road/Pinery Parkway</u>	NB Right SB Left WB Right WB Right Accel	320-foot lane plus 180-foot transition taper ⁽¹⁾ 360-foot lane (225 feet for deceleration and 135 feet for vehicle storage) plus a 145-foot transition taper 100-foot lane plus 120-foot transition taper 580-foot lane plus 180-foot transition taper ⁽¹⁾
6	<u>Pinery Parkway/Bayou Gulch Road</u>	EB Left EB Right WB Left WB Right NB Left NB Right SB Left SB Right	350-foot lane (190 feet for deceleration and 160 feet for vehicle storage) plus a 120-foot transition taper 190-foot lane plus 120-foot transition taper 240-foot lane (190 feet for deceleration and 50 feet for vehicle storage) plus a 120-foot transition taper Continuous lane from Three-Quarter Access 250-foot lane (225 feet for deceleration and 25 feet for vehicle storage) plus a 145-foot transition taper Continuous lane from Cielo Access 250-foot dual lane for vehicle storage, 225 feet for deceleration (one lane) plus a 12:1 transition taper Continuous lane back to North Site Access
8	<u>Pinery Parkway/Far West Site Access</u>	EB Left EB Right WB Left	150-foot lane plus a 120-foot transition taper 150-foot lane plus a 120-foot transition taper 150-foot lane plus a 120-foot transition taper
9	<u>Pinery Parkway/Near West Site Access</u>	EB Left WB Left	150-foot lane plus a 120-foot transition taper 150-foot lane plus a 120-foot transition taper
10	<u>Pinery Parkway/Three-Quarter Access</u>	EB Right EB Left WB Left	Continuous lane from Bayou Gulch Road 150-foot lane plus a 120-foot transition taper 150-foot lane plus a 120-foot transition taper
11	<u>Pinery Parkway/Far East Site Access</u>	EB Left WB Left	150-foot lane plus a 120-foot transition taper 150-foot lane plus a 120-foot transition taper
12	<u>Bayou Gulch Road/North Site Access</u>	WB Left EB Left NB Left NB Right SB Left SB Right	100-foot lane plus 96-foot transition taper 100-foot lane plus 96-foot transition taper 250-foot lane (225 feet for deceleration and 25 feet for vehicle storage) plus a 145-foot transition taper Continuous lane back to N. Pinery Parkway 320-foot lane (225 feet for deceleration and 95 feet for vehicle storage) plus a 145-foot transition taper 100-foot lane plus 145-foot transition taper

Note: Appropriate redirect tapers for a 35 mph and a 40 mph posted speed limit are 20:1 and 30:1.
(1) Lengths modified per feedback from Town staff.

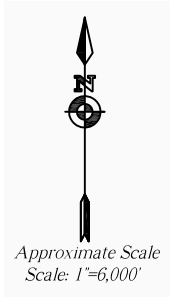
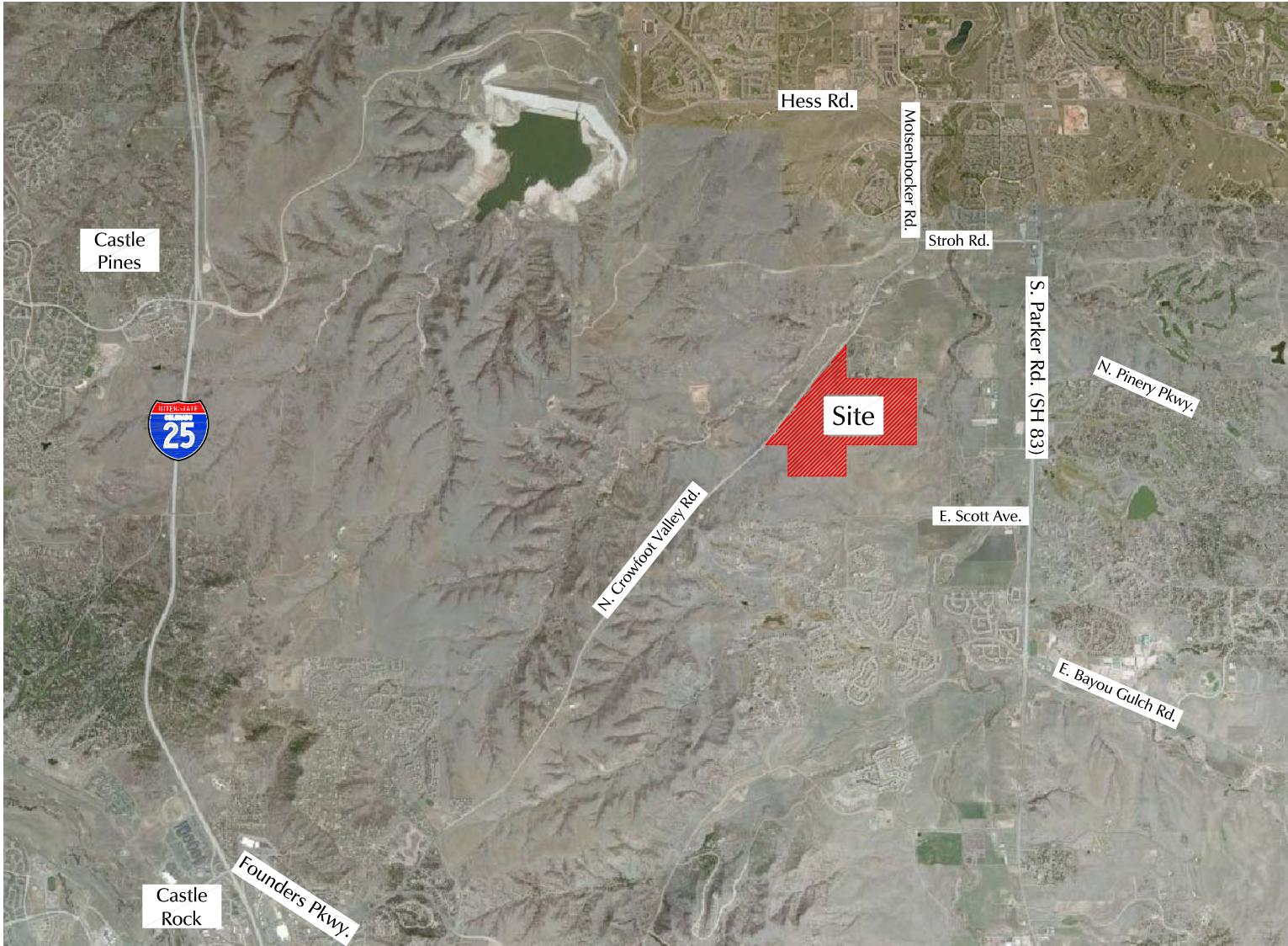

Figure 1
**Vicinity
Map**

Trails at Crowfoot (LSC #160711)

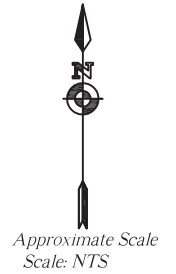
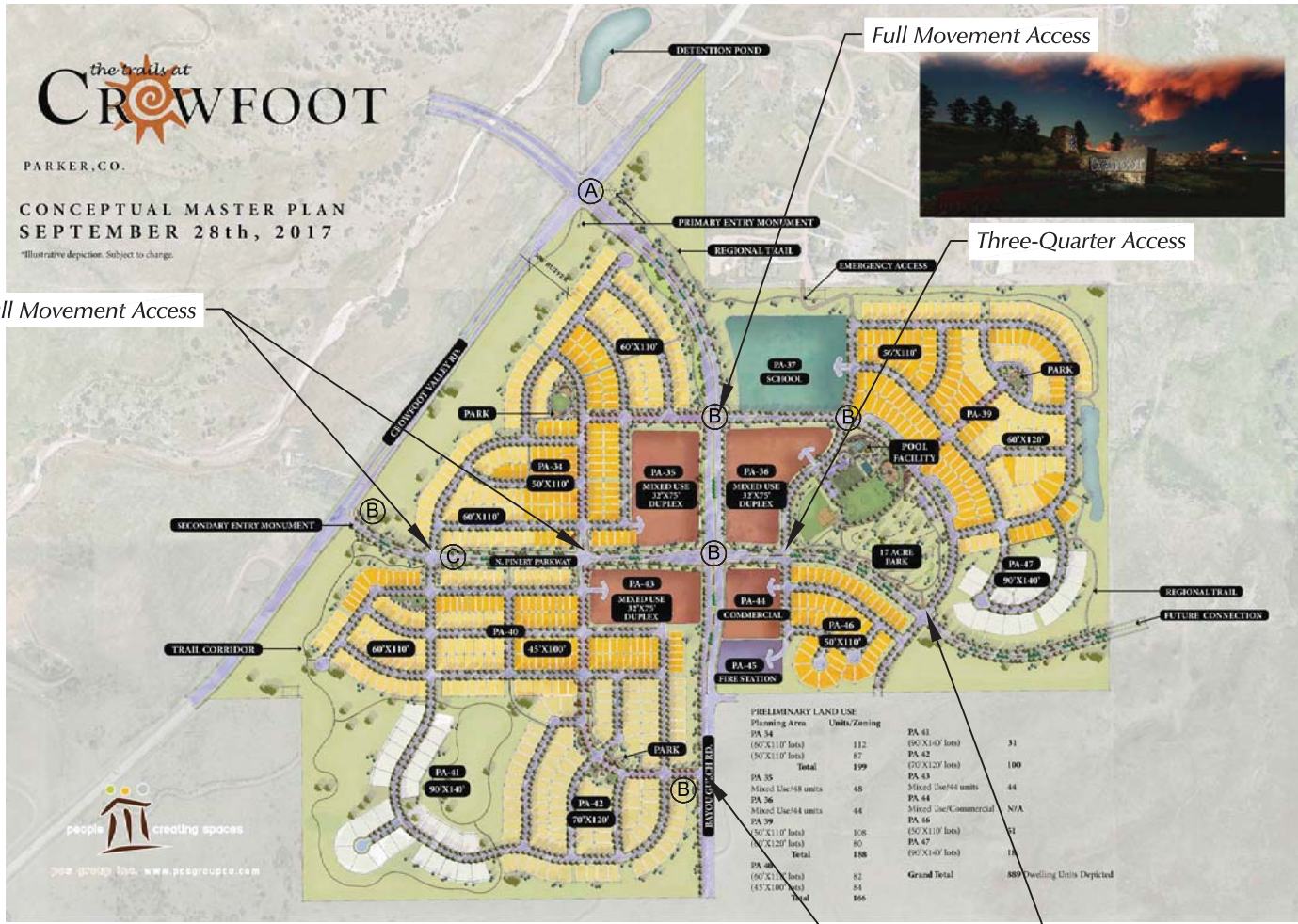
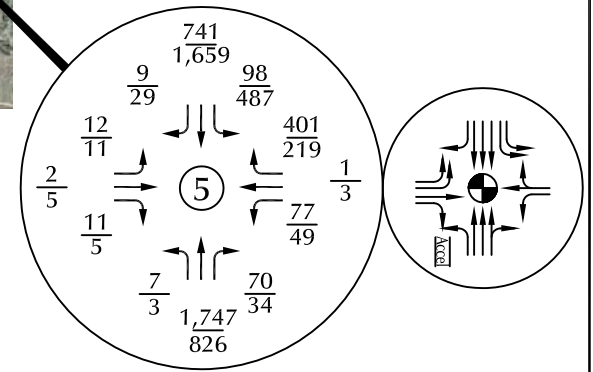
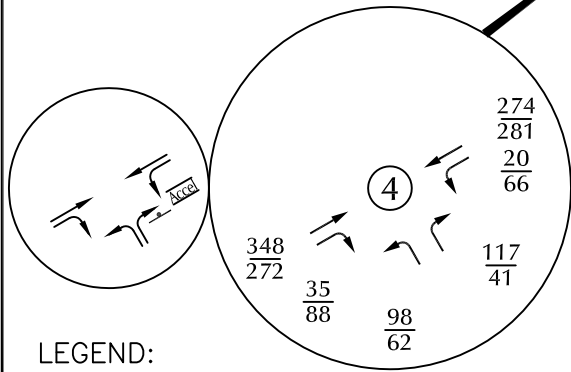
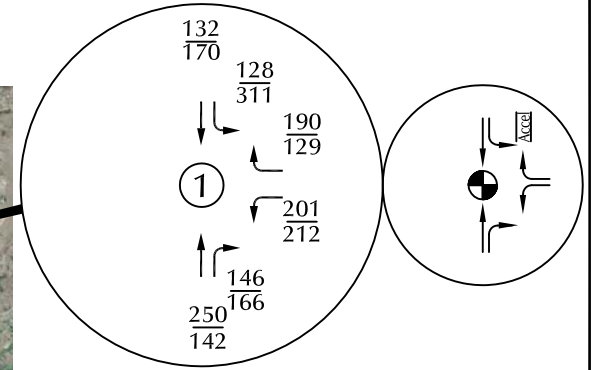
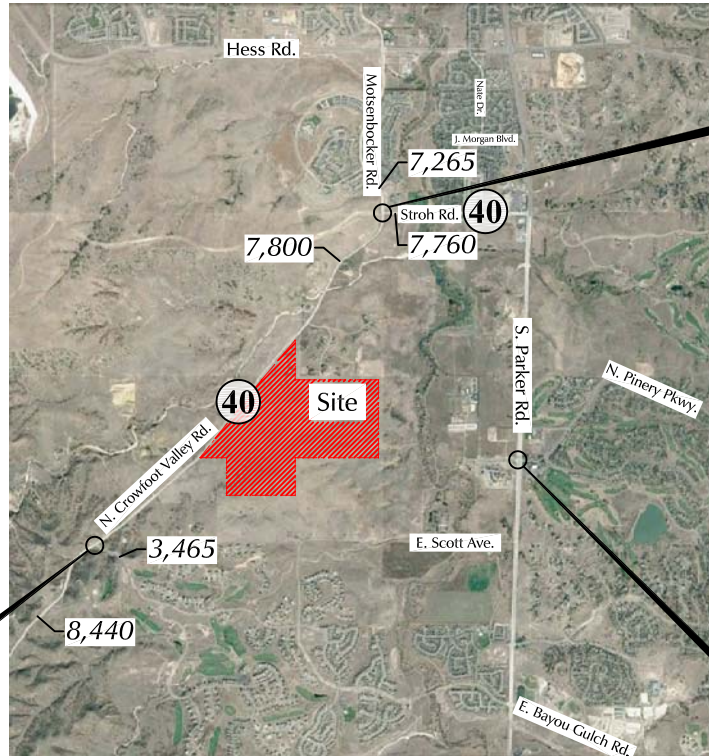
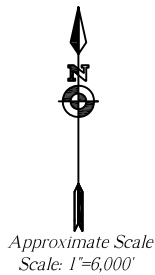

Figure 2
Site Plan

Trails at Crowfoot (LSC #160711)



- LEGEND:
- ↓ = Stop Sign
 - ⊙ = Traffic Signal
 - ⓪40 = Posted Speed Limit
 - $\frac{26}{35}$ = AM Peak Hour Traffic / PM Peak Hour Traffic
 - 1,000 = Average Daily Traffic

Figure 3
**Existing Traffic, Lane
Geometry and Traffic Control**
Trails at Crowfoot (LSC #160711)

* A dedicated westbound right-turn lane and a right-turn acceleration lane are needed to mitigate poor levels of service.

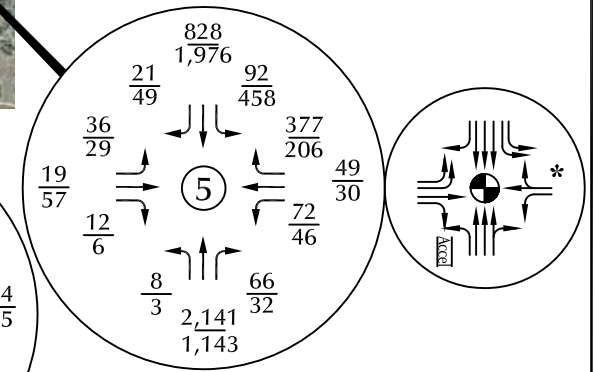
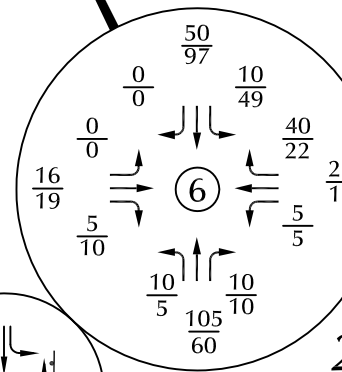
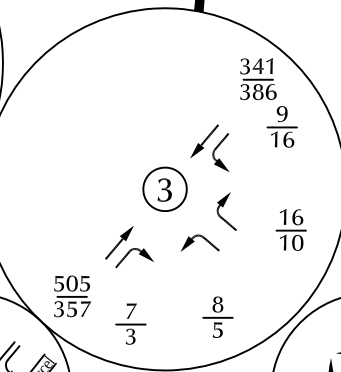
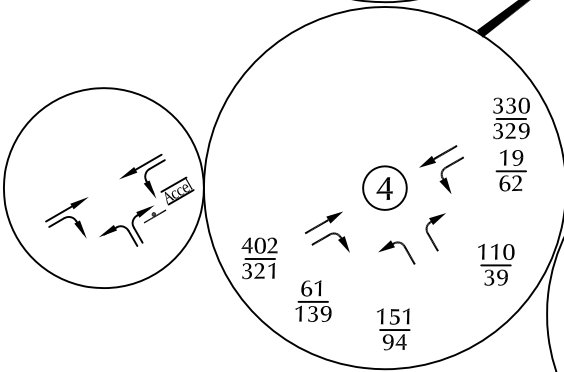
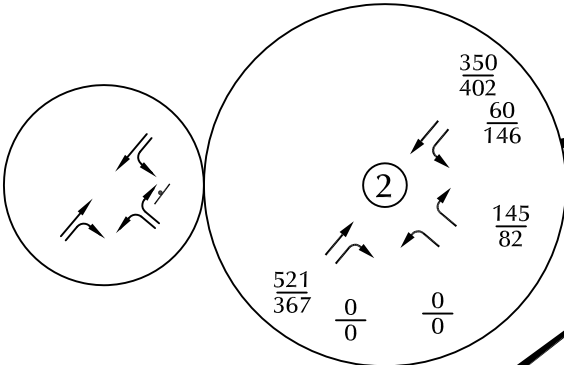
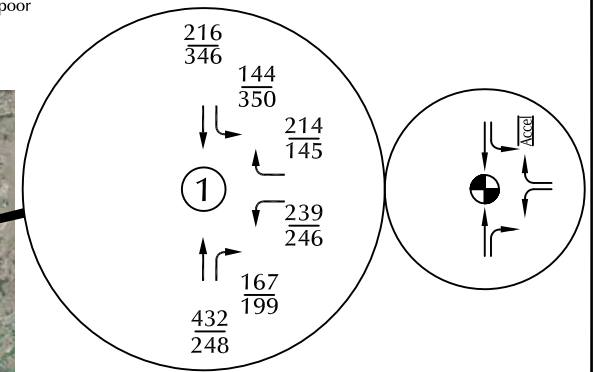
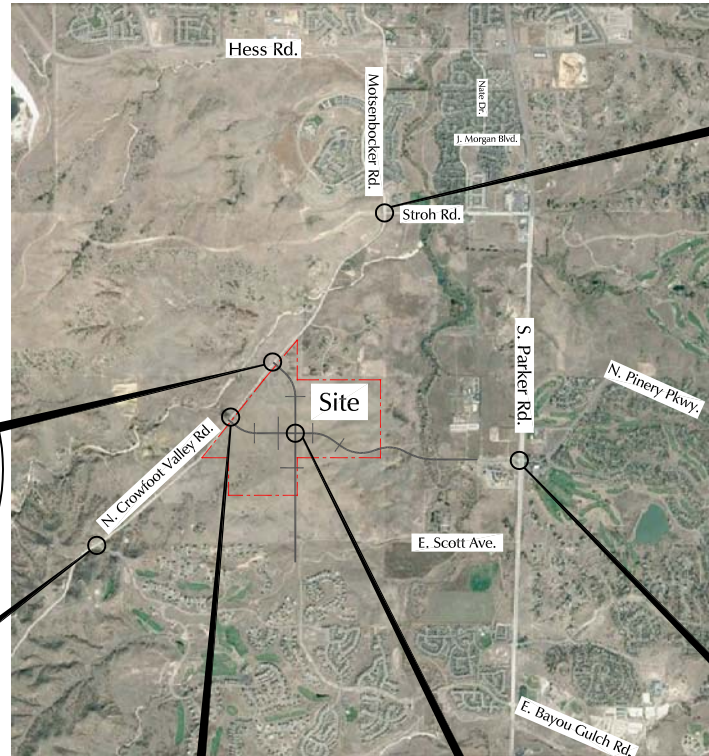

LEGEND:

- ⊥ = Stop Sign
- ⊙ = Traffic Signal
- $\frac{26}{35}$ = AM Peak Hour Traffic / PM Peak Hour Traffic
- 1,000 = Average Daily Traffic

Figure 4a

2025 Background Traffic, Lane Geometry and Traffic Control

Trails at Crowfoot (LSC #160711)

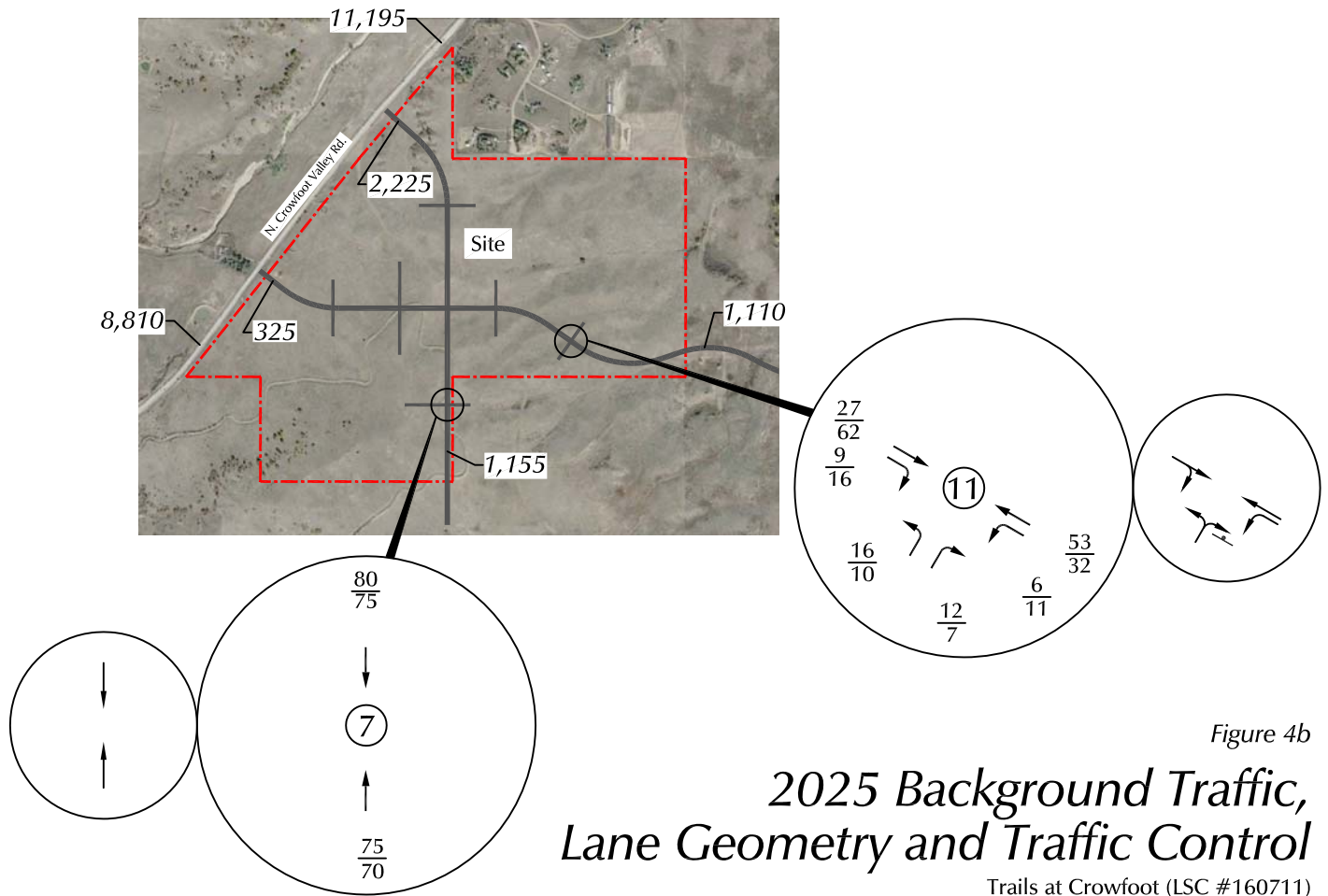
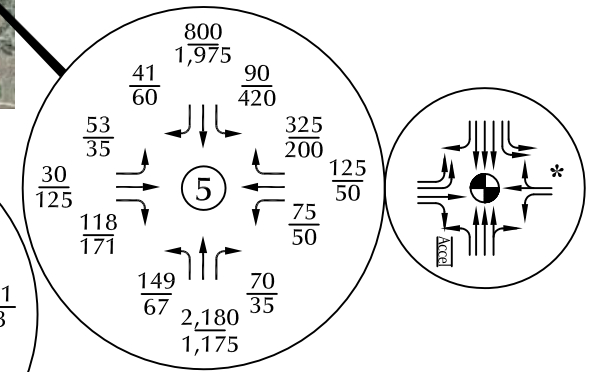
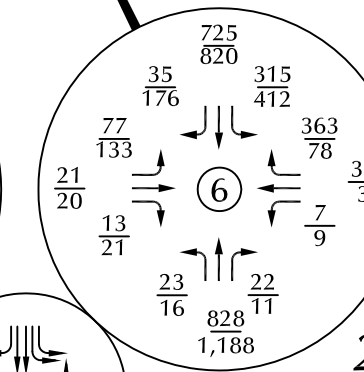
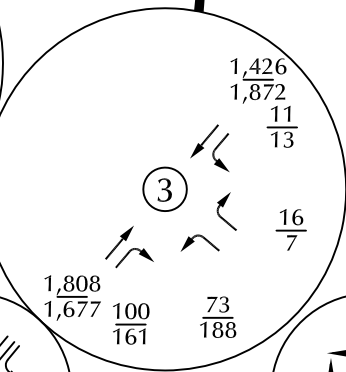
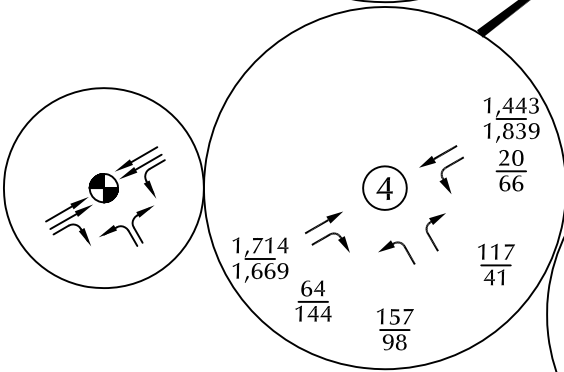
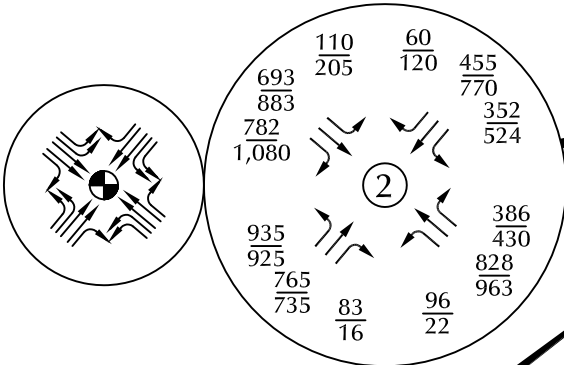
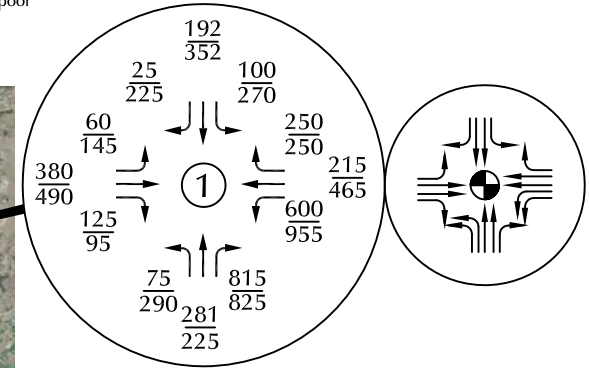
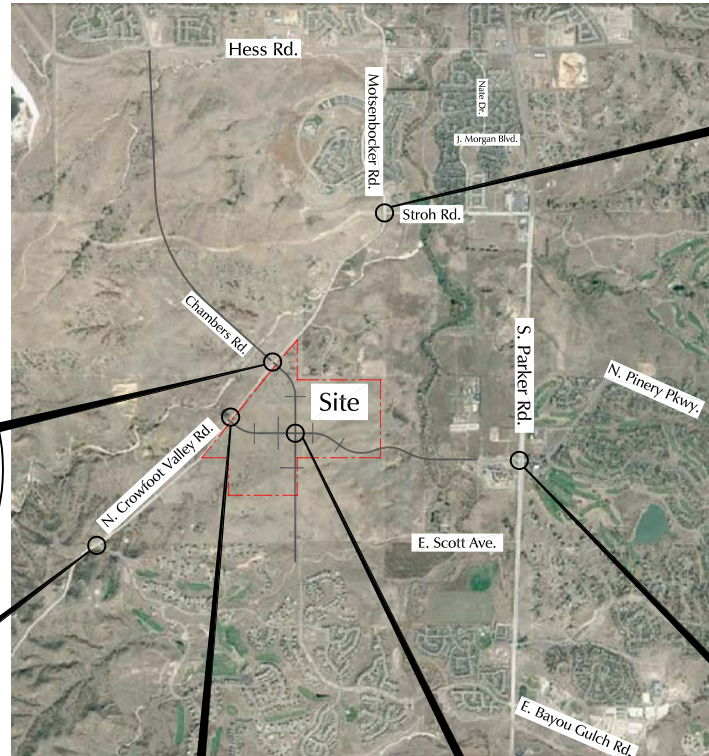

Figure 4b
**2025 Background Traffic,
Lane Geometry and Traffic Control**
Trails at Crowfoot (LSC #160711)

* A dedicated westbound right-turn lane and a right-turn acceleration lane are needed to mitigate poor levels of service.



LEGEND:
 † = Stop Sign
 ⊕ = Traffic Signal
 $\frac{26}{35}$ = AM Peak Hour Traffic / PM Peak Hour Traffic
 1,000 = Average Daily Traffic

Figure 5a
**2037 Background Traffic,
 Lane Geometry and Traffic Control**

Trails at Crowfoot (LSC #160711)

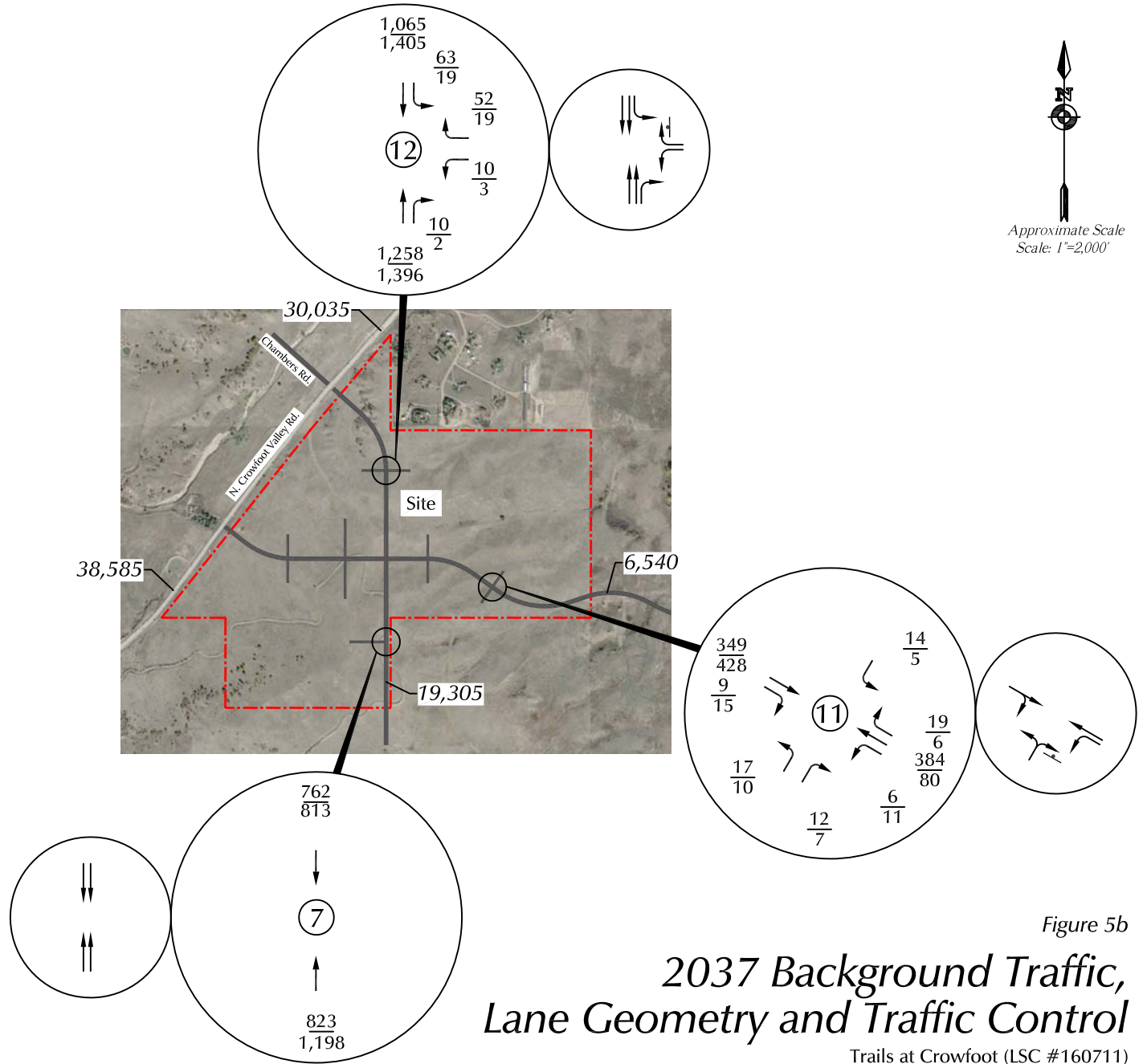

Approximate Scale
Scale: 1"=2,000'

Figure 5b
**2037 Background Traffic,
Lane Geometry and Traffic Control**
Trails at Crowfoot (LSC #160711)



Approximate Scale
Scale: 1"=6,000'

LEGEND:

$\frac{5\%}{5\%}$ = Short-Term Percent Directional Distribution
 $\frac{5\%}{5\%}$ = Long-Term Percent Directional Distribution

*Directional Distribution
of Site Generated Traffic*

Trails at Crowfoot (LSC #160711)

Figure 6

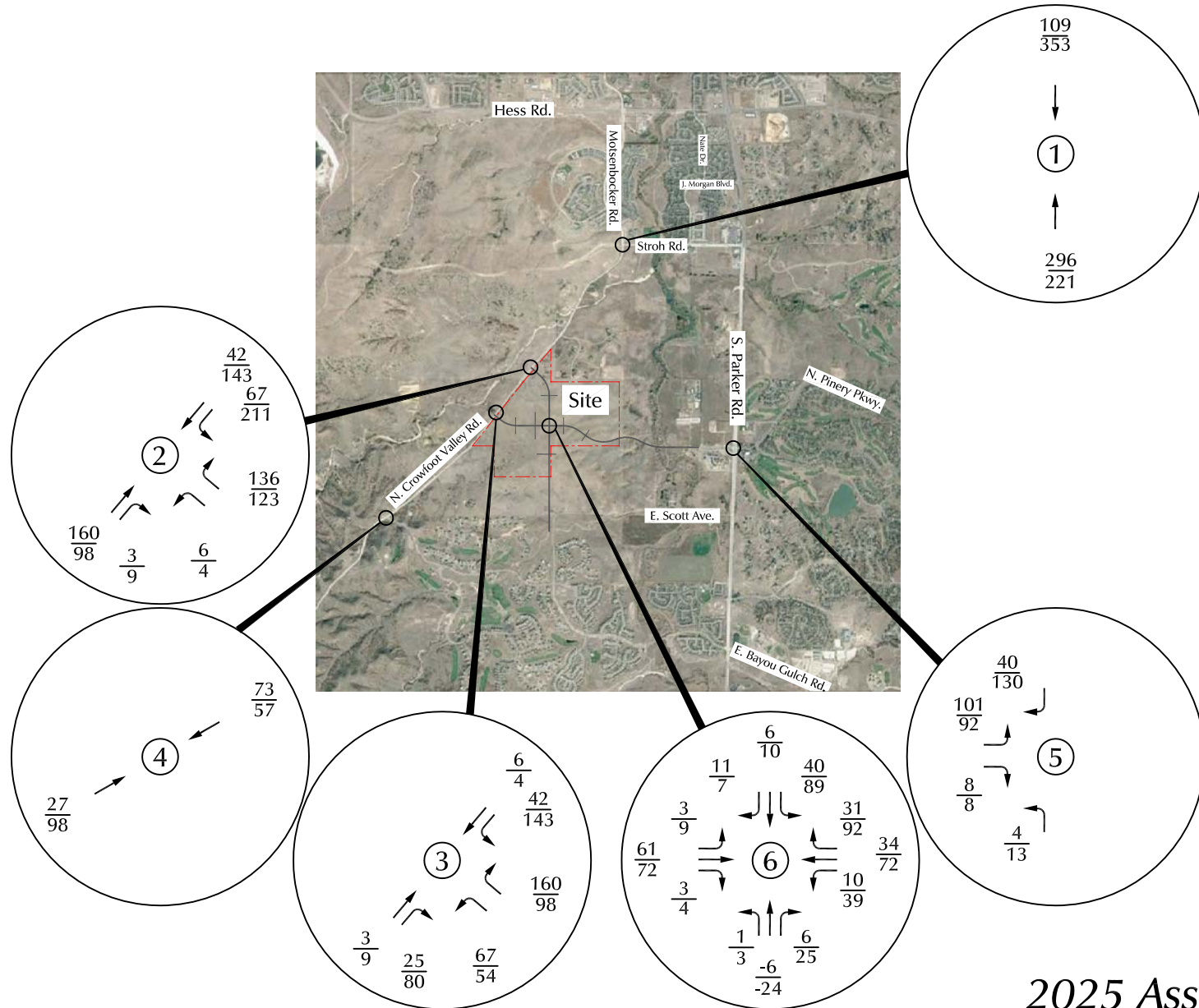

LEGEND:

$\frac{26}{35}$ = AM Peak Hour Traffic
 $\frac{35}{26}$ = PM Peak Hour Traffic
 1,000 = Average Daily Traffic

Figure 7a

2025 Assignment of Site Generated Traffic

Trails at Crowfoot (LSC #160711)

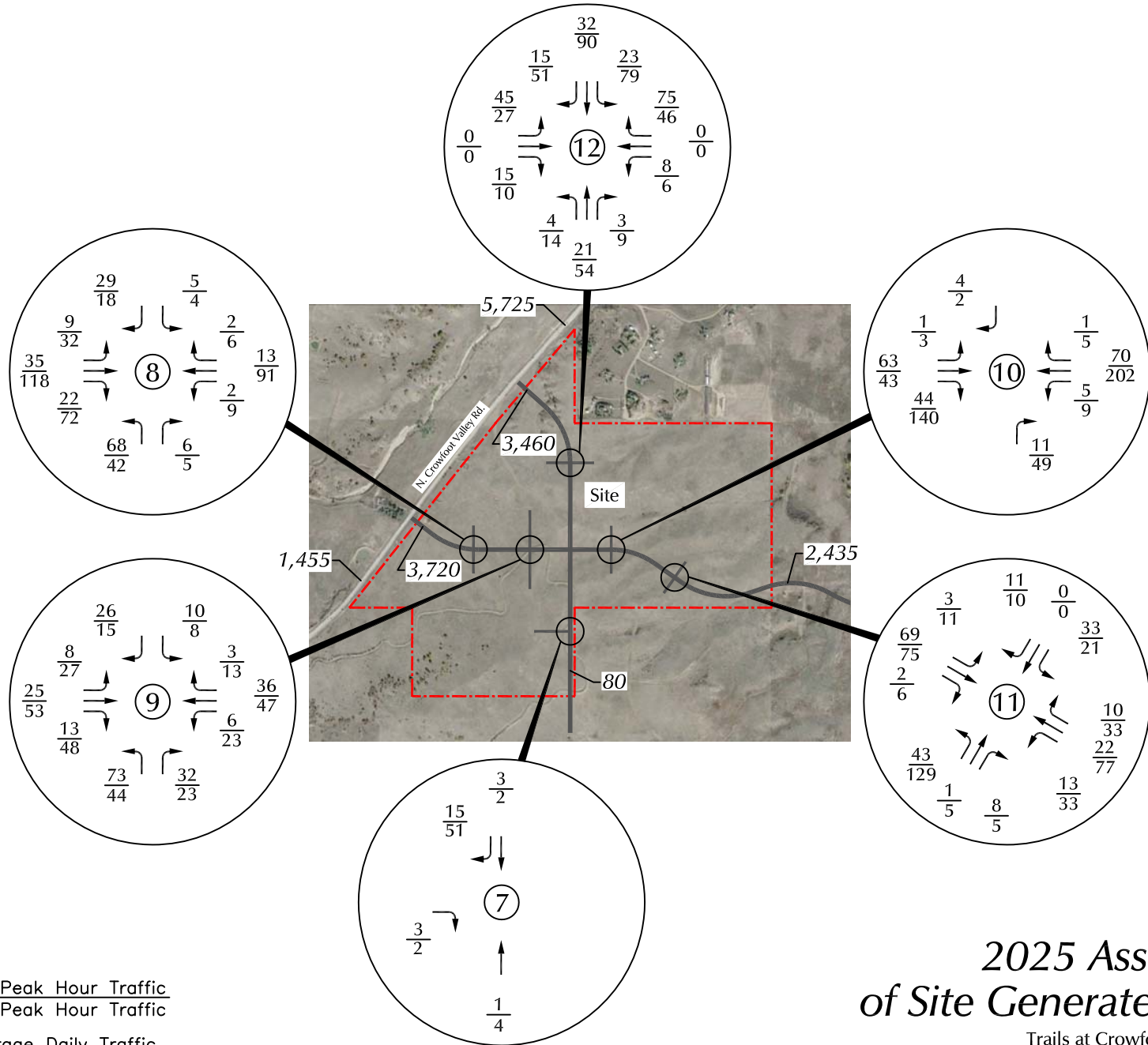

Approximate Scale
Scale: 1"=2,000'

LEGEND:

$\frac{26}{35}$ = AM Peak Hour Traffic
 = PM Peak Hour Traffic
 1,000 = Average Daily Traffic

Figure 7b
**2025 Assignment
 of Site Generated Traffic**
 Trails at Crowfoot (LSC #160711)

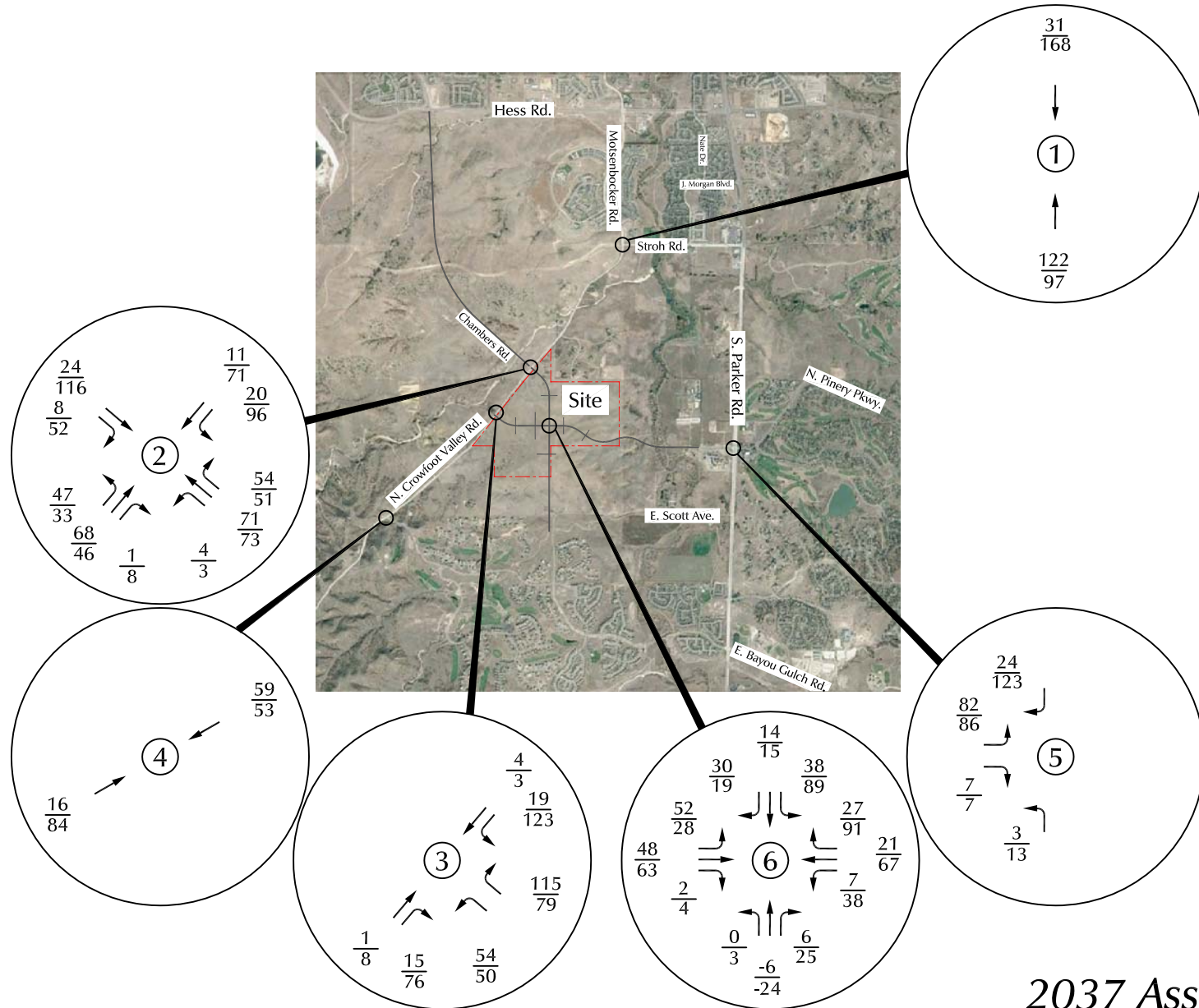

LEGEND:
 $\frac{26}{35}$ = AM Peak Hour Traffic
 $\frac{35}{26}$ = PM Peak Hour Traffic
 1,000 = Average Daily Traffic

Figure 8a
**2037 Assignment
 of Site Generated Traffic**
 Trails at Crowfoot (LSC #160711)

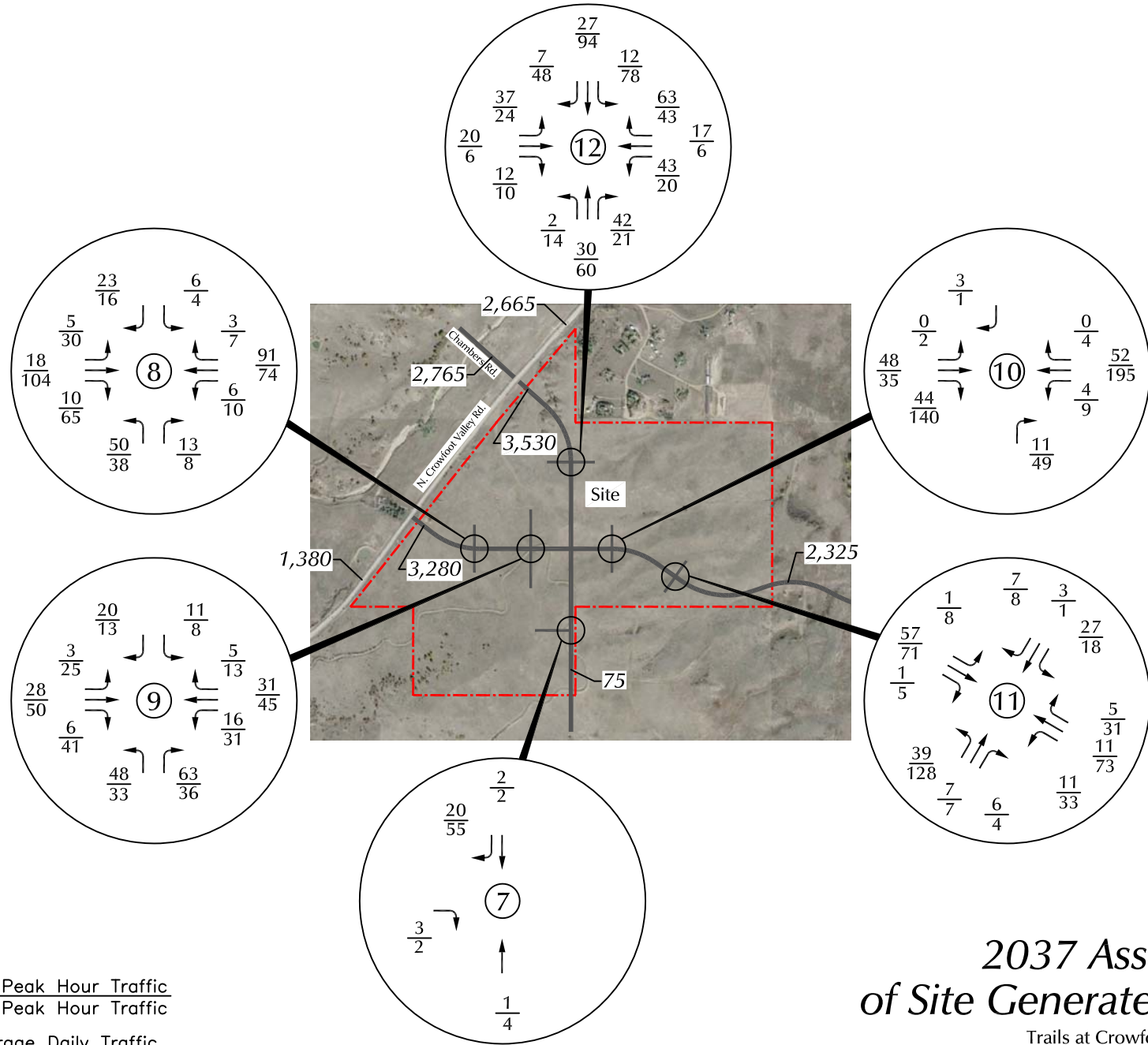

Approximate Scale
Scale: 1"=2,000'

LEGEND:

$\frac{26}{35}$ = AM Peak Hour Traffic
 $\frac{35}{35}$ = PM Peak Hour Traffic
 1,000 = Average Daily Traffic

Figure 8b
**2037 Assignment
 of Site Generated Traffic**
 Trails at Crowfoot (LSC #160711)

* A dedicated westbound right-turn lane and a right-turn acceleration lane are needed to mitigate poor levels of service.

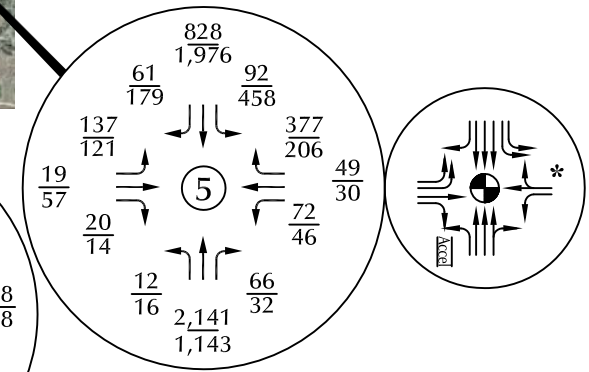
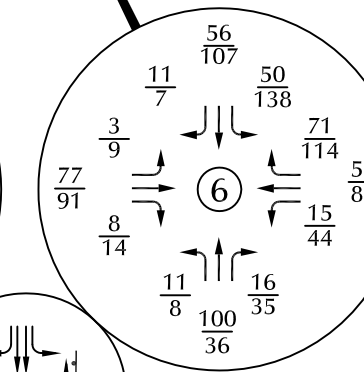
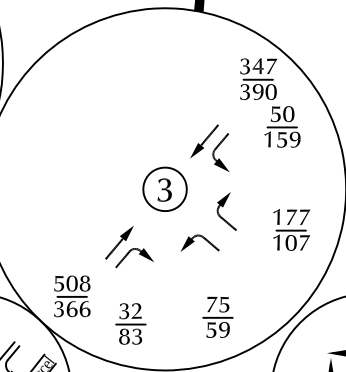
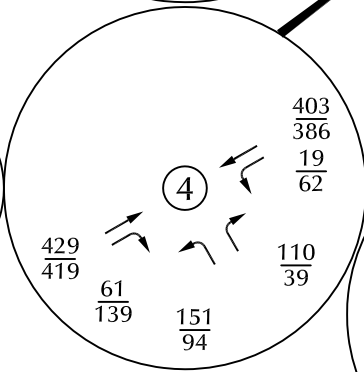
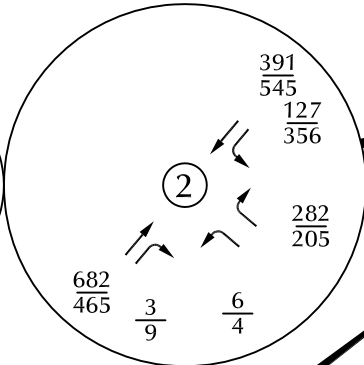
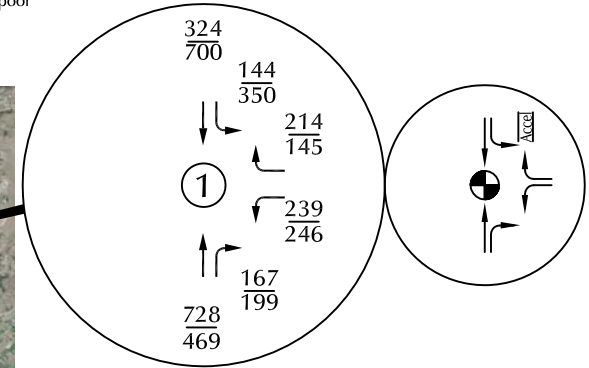
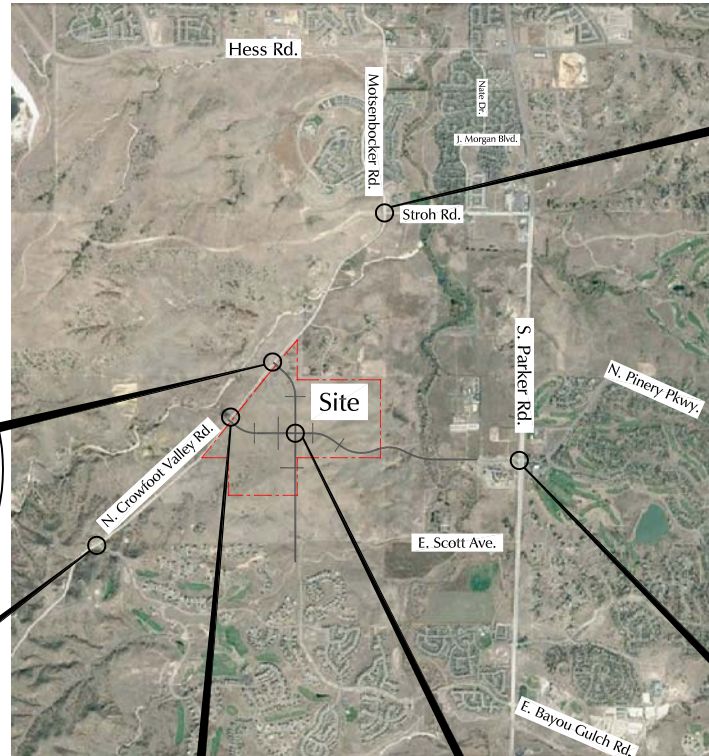

LEGEND:

- ↓ = Stop Sign
- ⊕ = Traffic Signal
- $\frac{26}{35}$ = AM Peak Hour Traffic / PM Peak Hour Traffic
- 1,000 = Average Daily Traffic

Figure 9a

2025 Total Traffic, Lane Geometry and Traffic Control

Trails at Crowfoot (LSC #160711)

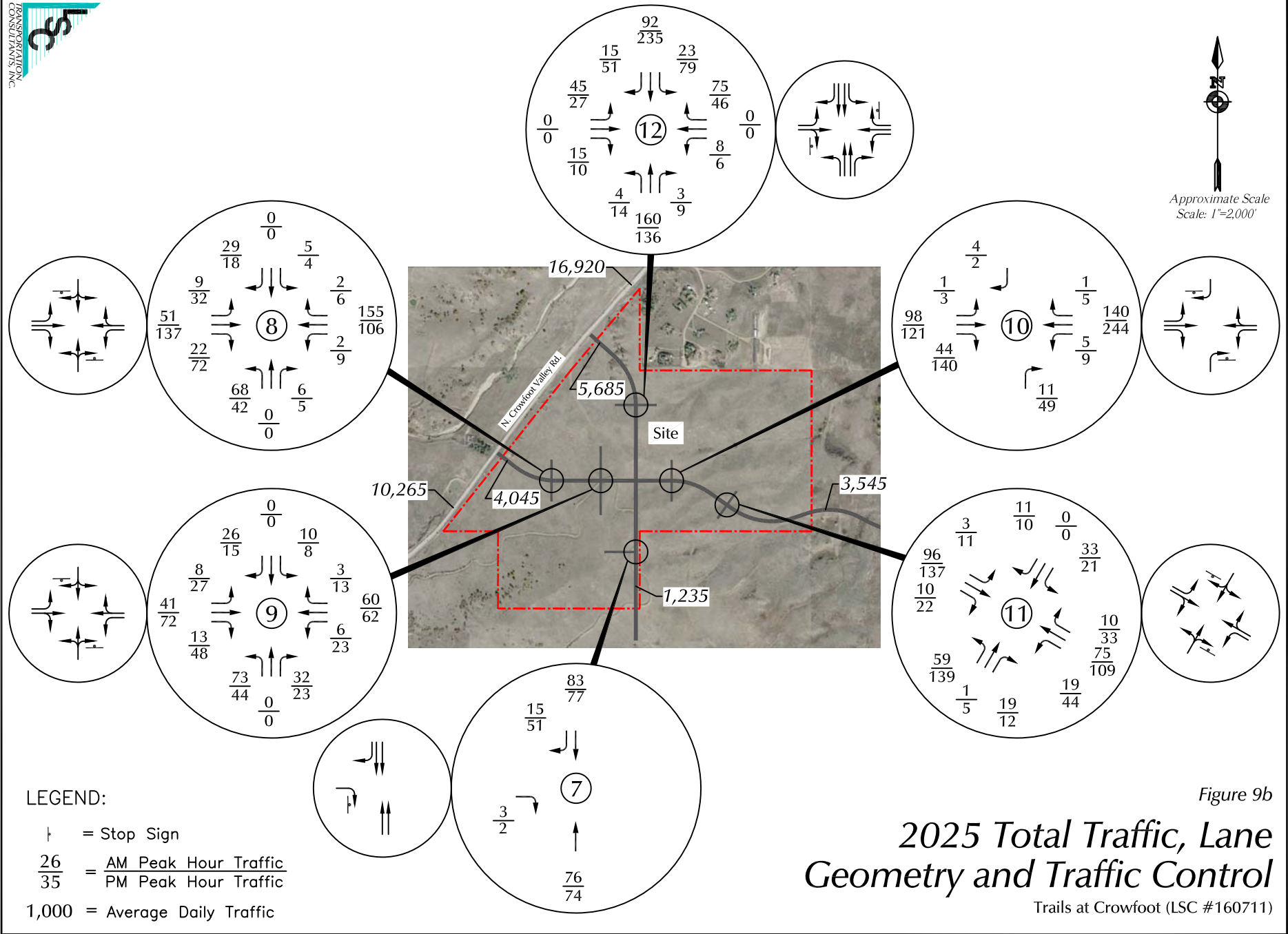

* A dedicated westbound right-turn lane and a right-turn acceleration lane are needed to mitigate poor levels of service.

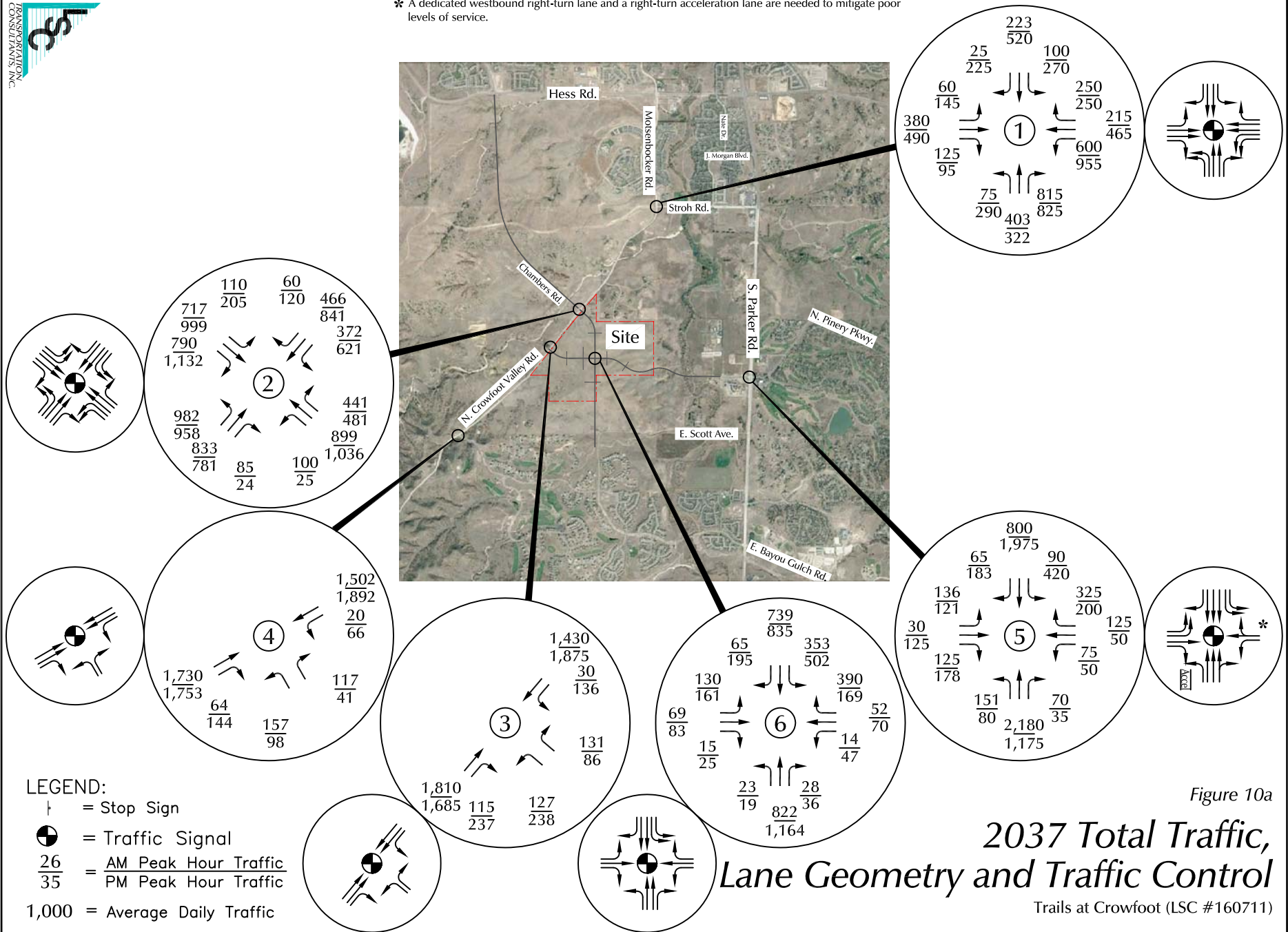
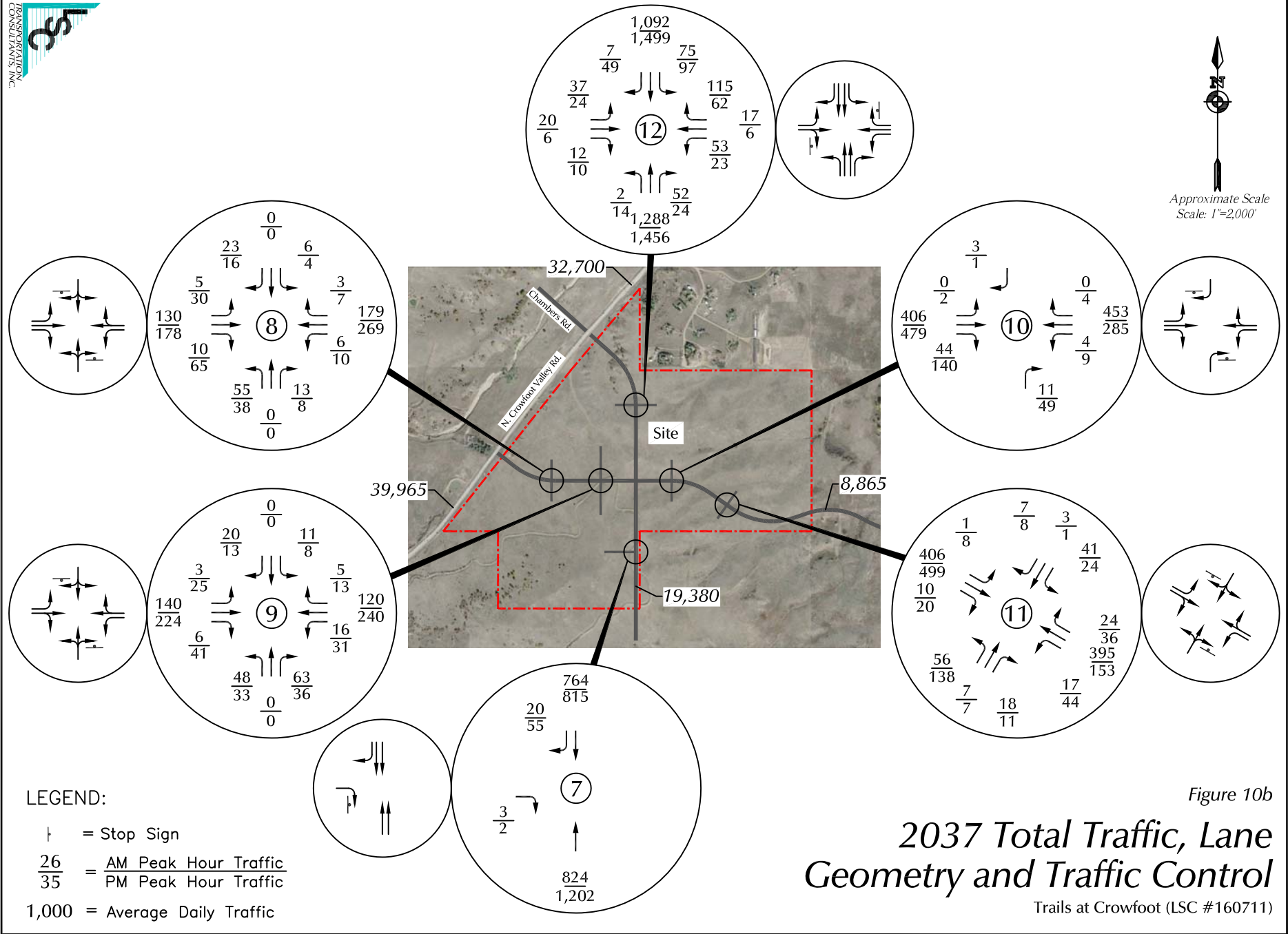

Figure 10a

2037 Total Traffic, Lane Geometry and Traffic Control

Trails at Crowfoot (LSC #160711)



COUNTER MEASURES INC.

1889 YORK STREET
DENVER.COLORADO
303-333-7409

N/S STREET: MOTSENBOCKER RD
E/W STREET: HESS RD
CITY: PARKER
COUNTY: DOUGLAS

File Name : MOTSHESSA
Site Code : 00000014
Start Date : 5/3/2017
Page No : 1

Groups Printed- VEHICLES

Start Time	MOTSENBOCKER RD Southbound				HESS RD Westbound				MOTSENBOCKER RD Northbound				HESS RD Eastbound				Int. Total
	Left	Thru	Right	Peds	Left	Thru	Right	Peds	Left	Thru	Right	Peds	Left	Thru	Right	Peds	
Factor	1.0	1.0	1.0	1.0	1.0	1.0	1.0	1.0	1.0	1.0	1.0	1.0	1.0	1.0	1.0	1.0	
06:30 AM	8	5	0	0	16	233	10	0	69	4	22	0	2	52	13	0	434
06:45 AM	19	8	0	0	19	234	18	0	102	15	30	0	3	99	19	0	566
Total	27	13	0	0	35	467	28	0	171	19	52	0	5	151	32	0	1000
07:00 AM	11	7	1	0	18	270	8	0	107	18	38	0	3	103	22	0	606
07:15 AM	15	9	1	0	16	304	12	0	155	34	44	0	5	108	19	0	722
07:30 AM	21	20	0	0	23	329	37	0	165	42	33	0	0	111	29	0	810
07:45 AM	35	27	2	0	27	272	26	0	175	38	28	0	2	82	39	0	753
Total	82	63	4	0	84	1175	83	0	602	132	143	0	10	404	109	0	2891
08:00 AM	16	11	1	0	18	261	12	0	160	26	17	0	5	94	39	0	660
08:15 AM	25	14	0	0	22	232	13	0	146	30	33	0	1	146	57	0	719
Total	41	25	1	0	40	493	25	0	306	56	50	0	6	240	96	0	1379
04:00 PM	20	21	4	1	39	102	6	0	59	22	66	0	2	189	110	1	642
04:15 PM	23	21	4	0	41	138	15	2	36	17	29	0	3	267	108	0	704
04:30 PM	16	20	2	0	25	120	21	4	36	16	26	0	4	270	109	0	669
04:45 PM	6	18	3	0	31	114	14	2	34	15	28	0	3	269	103	0	640
Total	65	80	13	1	136	474	56	8	165	70	149	0	12	995	430	1	2655
05:00 PM	21	16	0	0	39	98	10	1	45	14	28	0	1	261	86	2	622
05:15 PM	11	24	1	0	19	138	10	0	31	16	28	0	3	331	128	2	742
05:30 PM	17	20	3	0	26	103	18	0	36	15	32	0	2	285	103	0	660
05:45 PM	16	12	0	0	33	113	6	0	24	12	36	0	3	285	105	2	647
Total	65	72	4	0	117	452	44	1	136	57	124	0	9	1162	422	6	2671
Grand Total	280	253	22	1	412	3061	236	9	1380	334	518	0	42	2952	1089	7	10596
Apprch %	50.4	45.5	4.0	0.2	11.1	82.3	6.3	0.2	61.8	15.0	23.2	0.0	1.0	72.2	26.6	0.2	
Total %	2.6	2.4	0.2	0.0	3.9	28.9	2.2	0.1	13.0	3.2	4.9	0.0	0.4	27.9	10.3	0.1	

COUNTER MEASURES INC.

1889 YORK STREET
DENVER, COLORADO
303-333-7409

N/S STREET: MOTSENBOCKER RD
EW STREET: HESS RD
CITY: PARKER
COUNTY: DOUGLAS

File Name : MOTSHESSA
Site Code : 00000014
Start Date : 5/3/2017
Page No : 2

Start Time	MOTSENBOCKER RD Southbound					HESS RD Westbound					MOTSENBOCKER RD Northbound					HESS RD Eastbound					Int. Total
	Left	Thru	Rig ht	Ped s	App. Total	Left	Thru	Rig ht	Ped s	App. Total	Left	Thru	Rig ht	Ped s	App. Total	Left	Thru	Rig ht	Ped s	App. Total	
Peak Hour From 07:00 AM to 07:45 AM - Peak 1 of 1																					
Intersection	07:00 AM																				
Volume	82	63	4	0	149	84	117	83	0	1342	602	132	143	0	877	10	404	109	0	523	2891
Percent	55.0	42.3	2.7	0.0		6.3	87.6	6.2	0.0		68.6	15.1	16.3	0.0		1.9	77.2	20.8	0.0		
07:30 Volume	21	20	0	0	41	23	329	37	0	389	165	42	33	0	240	0	111	29	0	140	810
Peak Factor																					0.892
High Int. Volume	07:45 AM					07:30 AM					07:45 AM					07:30 AM					
Peak Factor	35	27	2	0	64	23	329	37	0	389	175	38	28	0	241	0	111	29	0	140	
						0.58					0.86					0.91					0.93
						2					2					0					4

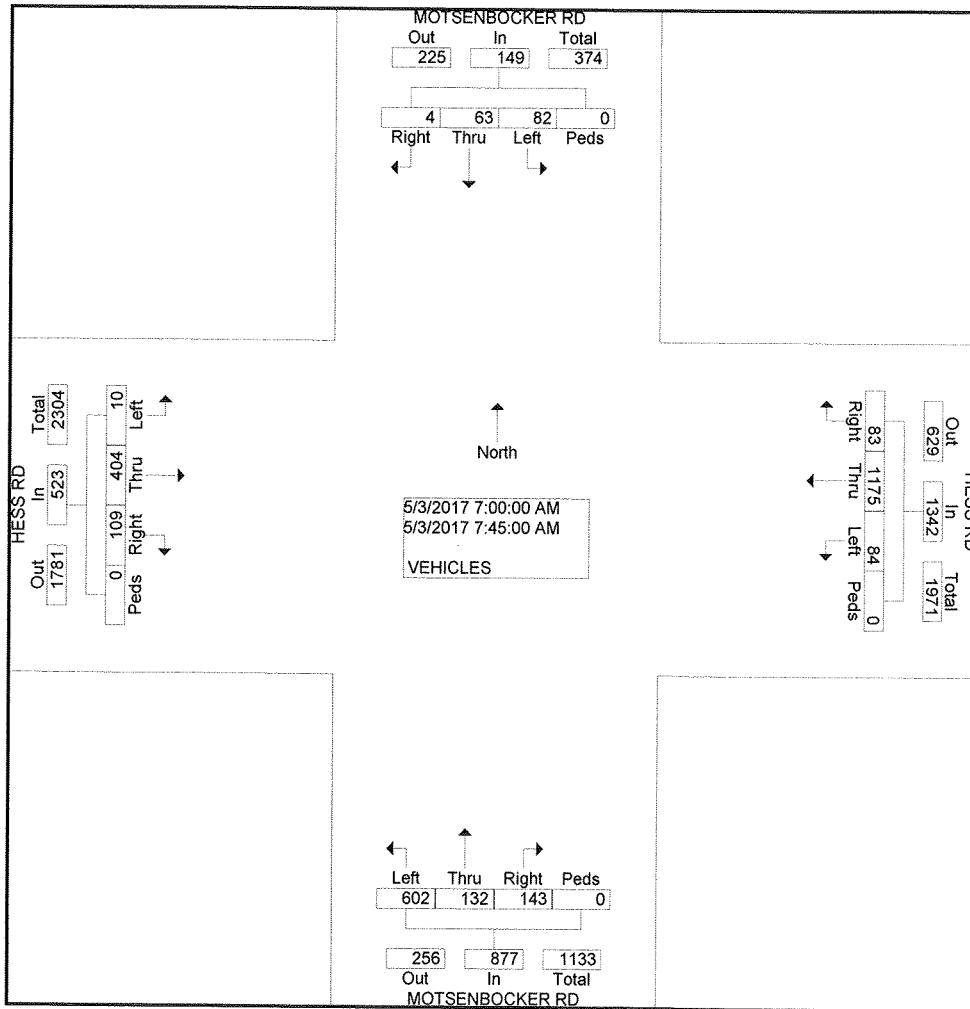

COUNTER MEASURES INC.

1889 YORK STREET
DENVER, COLORADO
303-333-7409

N/S STREET: MOTSENBOCKER RD
E/W STREET: HESS RD
CITY: PARKER
COUNTY: DOUGLAS

File Name : MOTSHESSA
Site Code : 00000014
Start Date : 5/3/2017
Page No : 2

Start Time	MOTSENBOCKER RD Southbound					HESS RD Westbound					MOTSENBOCKER RD Northbound					HESS RD Eastbound					Int. Total
	Left	Thru	Rig ht	Ped s	App. Total	Left	Thru	Rig ht	Ped s	App. Total	Left	Thru	Rig ht	Ped s	App. Total	Left	Thru	Rig ht	Ped s	App. Total	
Peak Hour From 04:45 PM to 05:30 PM - Peak 1 of 1																					
Intersection	04:45 PM																				
Volume	55	78	7	0	140	115	453	52	3	623	146	60	116	0	322	9	114	420	4	1579	2664
Percent	39.3	55.7	5.0	0.0		18.5	72.7	8.3	0.5		45.3	18.6	36.0	0.0		0.6	72.6	26.6	0.3		
05:15 Volume	11	24	1	0	36	19	138	10	0	167	31	16	28	0	75	3	331	128	2	464	742
Peak Factor																					
High Int. Volume	05:30 PM					05:15 PM					05:00 PM					05:15 PM					
Peak Factor	17	20	3	0	40	19	138	10	0	167	45	14	28	0	87	3	331	128	2	464	885
						0.87					0.93					0.92					1
						5					3					5					

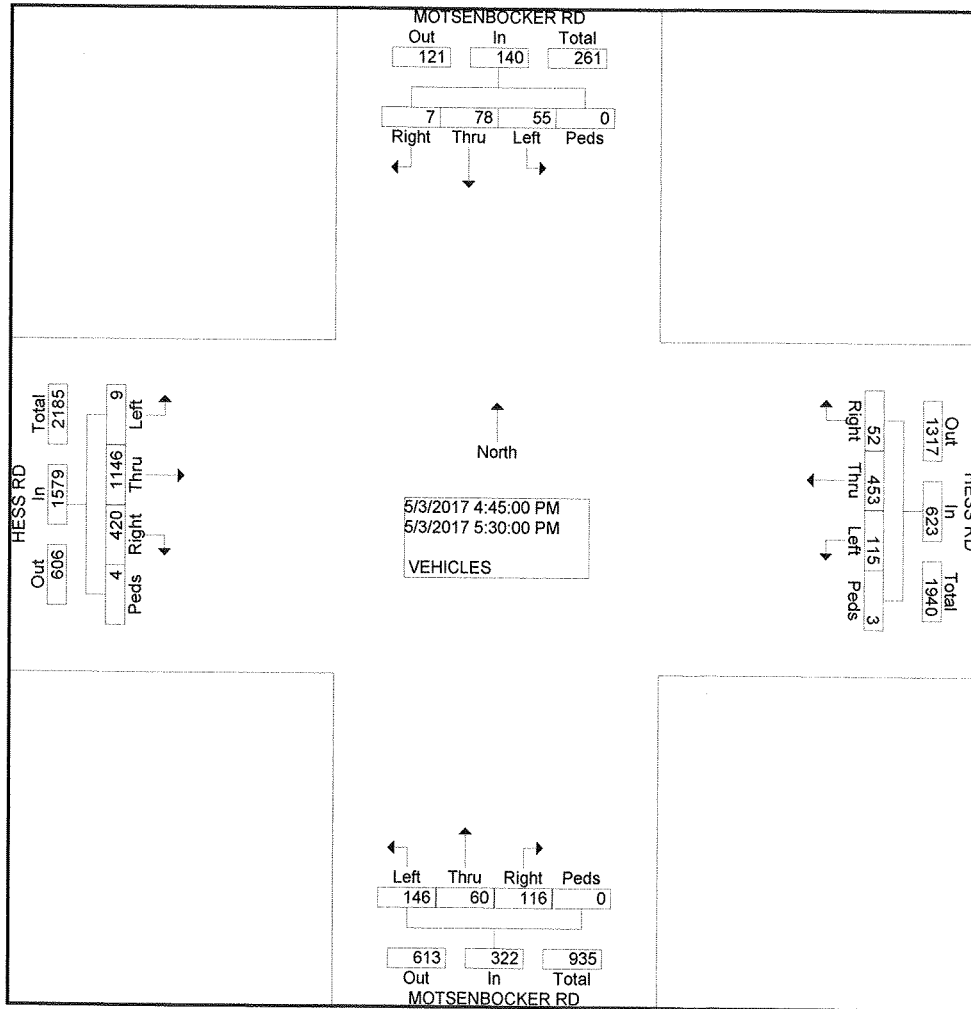

COUNTER MEASURES INC.

1889 YORK STREET
DENVER, COLORADO
303-333-7409

N/S STREET: MOTSENBOCKER RD/CROWFOOT RD
E/W STREET: STROH RD
CITY: PARKER
COUNTY: DOUGLAS

File Name : CROWSTRO
Site Code : 00000017
Start Date : 5/3/2017
Page No : 1

Groups Printed- VEHICLES

Start Time	MOTSENBOCKER RD Southbound				STROH RD Westbound				CROWFOOT VALLEY RD Northbound				Eastbound				Int. Total	
	Left	Thru	Right	Peds	Left	Thru	Right	Peds	Left	Thru	Right	Peds	Left	Thru	Right	Peds		
Factor	1.0	1.0	1.0	1.0	1.0	1.0	1.0	1.0	1.0	1.0	1.0	1.0	1.0	1.0	1.0	1.0	1.0	
06:30 AM	14	21	0	0	24	0	24	0	0	17	26	0	0	0	0	0	0	126
06:45 AM	22	19	0	0	30	0	26	0	0	40	25	0	0	0	0	0	0	162
Total	36	40	0	0	54	0	50	0	0	57	51	0	0	0	0	0	0	288
07:00 AM	35	28	0	0	48	0	42	0	0	47	26	0	0	0	0	0	0	226
07:15 AM	26	26	0	0	51	0	45	0	0	52	46	0	0	0	0	0	0	246
07:30 AM	26	30	0	0	59	0	58	0	0	85	48	0	0	0	0	0	0	306
07:45 AM	41	48	0	0	43	0	45	0	0	66	26	0	0	0	0	0	0	269
Total	128	132	0	0	201	0	190	0	0	250	146	0	0	0	0	0	0	1047
08:00 AM	27	32	0	0	32	0	43	0	0	45	27	0	0	0	0	0	0	206
08:15 AM	19	27	0	0	34	0	42	0	0	37	46	0	0	0	0	0	0	205
Total	46	59	0	0	66	0	85	0	0	82	73	0	0	0	0	0	0	411
04:00 PM	100	66	0	0	45	0	38	0	0	13	54	1	0	0	0	0	0	317
04:15 PM	63	42	0	0	47	0	33	0	0	29	56	1	0	0	0	0	0	271
04:30 PM	84	40	0	1	44	0	27	0	0	41	34	0	0	0	0	0	0	271
04:45 PM	74	54	0	0	56	0	37	0	0	39	47	1	0	0	0	0	0	308
Total	321	202	0	1	192	0	135	0	0	122	191	3	0	0	0	0	0	1167
05:00 PM	97	37	0	0	52	0	40	0	0	29	40	0	0	0	0	0	0	295
05:15 PM	67	42	0	0	50	0	28	0	0	41	44	0	0	0	0	0	0	272
05:30 PM	73	37	0	0	54	0	24	0	0	33	35	2	0	0	0	0	0	258
05:45 PM	73	43	0	0	47	0	37	0	0	23	44	0	0	0	0	0	0	267
Total	310	159	0	0	203	0	129	0	0	126	163	2	0	0	0	0	0	1092
Grand Total	841	592	0	1	716	0	589	0	0	637	624	5	0	0	0	0	0	4005
Apprch %	58.6	41.3	0.0	0.1	54.9	0.0	45.1	0.0	0.0	50.3	49.3	0.4	0.0	0.0	0.0	0.0	0.0	
Total %	21.0	14.8	0.0	0.0	17.9	0.0	14.7	0.0	0.0	15.9	15.6	0.1	0.0	0.0	0.0	0.0	0.0	

COUNTER MEASURES INC.

1889 YORK STREET
DENVER.COLORADO
303-333-7409

N/S STREET: MOTSENBOCKER RD/CROWFOOT RD
E/W STREET: STROH RD
CITY: PARKER
COUNTY: DOUGLAS

File Name : CROWSTRO
Site Code : 0000017
Start Date : 5/3/2017
Page No : 2

Start Time	MOTSENBOCKER RD Southbound					STROH RD Westbound					CROWFOOT VALLEY RD Northbound					Eastbound					Int. Total
	Left	Thru	Right	Peds	App. Total	Left	Thru	Right	Peds	App. Total	Left	Thru	Right	Peds	App. Total	Left	Thru	Right	Peds	App. Total	
Peak Hour From 06:30 AM to 08:30 AM - Peak 1 of 1																					
Intersection	07:00 AM																				
Volume	128	132	0	0	260	201	0	190	0	391	0	250	146	0	396	0	0	0	0	0	1047
Percent	49.2	50.8	0.0	0.0		51.4	0.0	48.6	0.0		0.0	63.1	36.9	0.0		0.0	0.0	0.0	0.0		
07:30 Volume	26	30	0	0	56	59	0	58	0	117	0	85	48	0	133	0	0	0	0	0	306
Peak Factor																					0.855
High Int.	07:45 AM																				
Volume	41	48	0	0	89	59	0	58	0	117	0	85	48	0	133	6:15:00 AM					
Peak Factor	0.730					0.835					0.744										

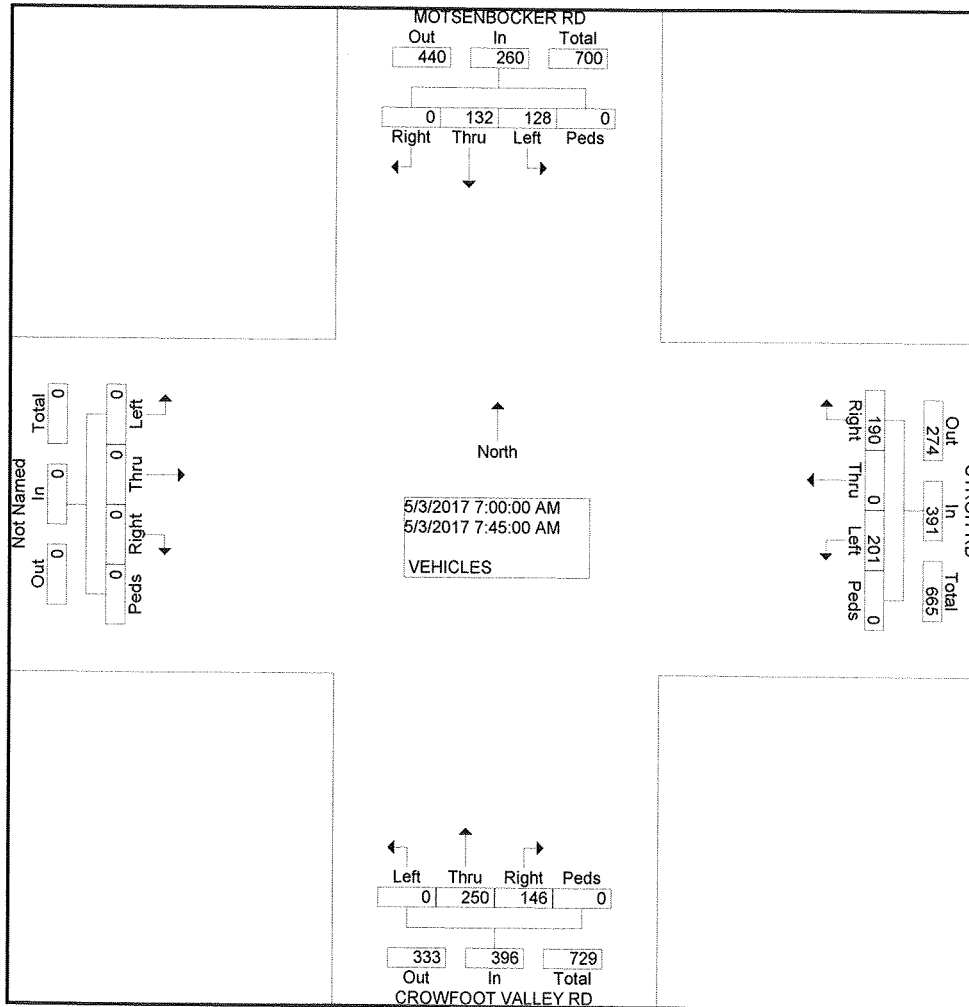

COUNTER MEASURES INC.

1889 YORK STREET
DENVER, COLORADO
303-333-7409

N/S STREET: MOTSENBOCKER RD/CROWFOOT RD
E/W STREET: STROH RD
CITY: PARKER
COUNTY: DOUGLAS

File Name : CROWSTRO
Site Code : 00000017
Start Date : 5/3/2017
Page No : 2

Start Time	MOTSENBOCKER RD Southbound					STROH RD Westbound					CROWFOOT VALLEY RD Northbound					Eastbound					Int. Total
	Left	Thru	Rig ht	Ped s	App. Total	Left	Thru	Rig ht	Ped s	App. Total	Left	Thru	Rig ht	Ped s	App. Total	Left	Thru	Rig ht	Ped s	App. Total	
Peak Hour From 04:45 PM to 05:30 PM - Peak 1 of 1																					
Intersecti on	04:45 PM																				
Volume	311	170	0	0	481	212	0	129	0	341	0	142	166	3	311	0	0	0	0	0	1133
Percent	64.7	35.3	0.0	0.0		62.2	0.0	37.8	0.0		0.0	45.7	53.4	1.0		0.0	0.0	0.0	0.0		
04:45 Volume	74	54	0	0	128	56	0	37	0	93	0	39	47	1	87	0	0	0	0	0	308
Peak Factor																					0.920
High Int. Volume	05:00 PM					04:45 PM					04:45 PM										
Peak Factor	97	37	0	0	134	56	0	37	0	93	0	39	47	1	87						
					0.89					0.91					0.89						
					7					7					4						

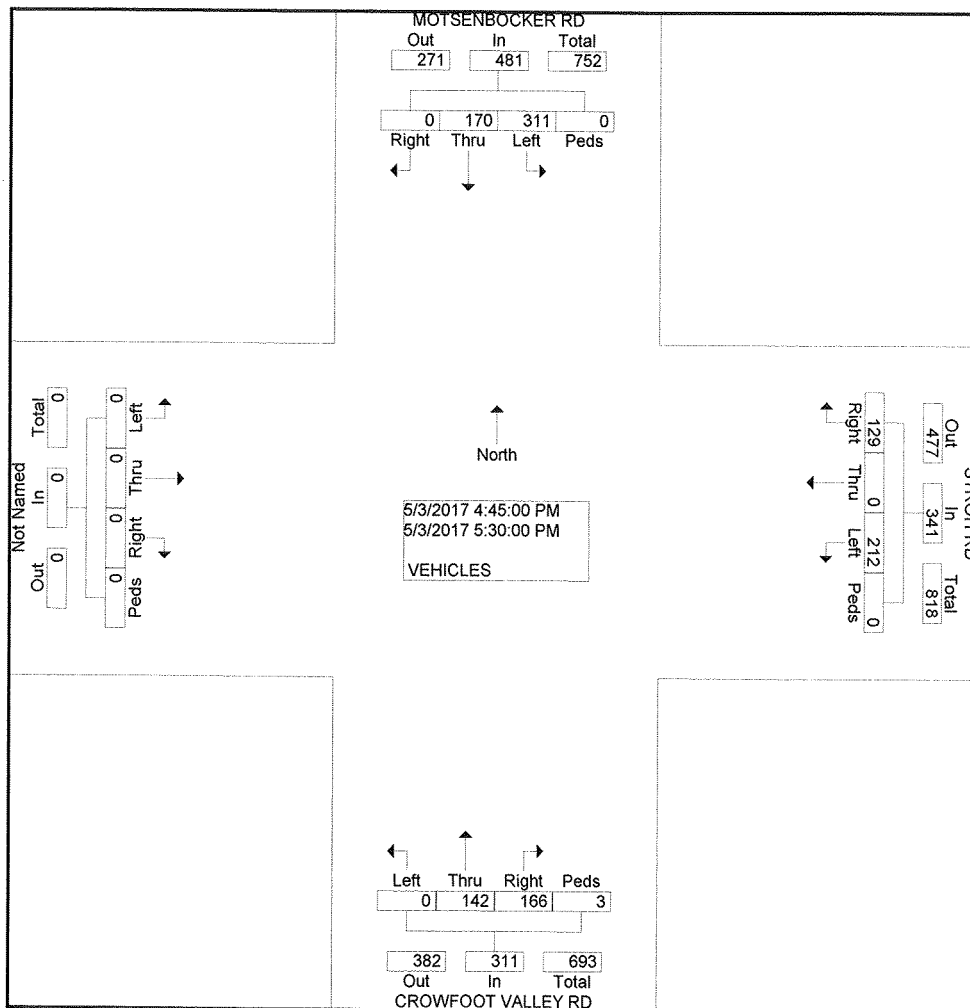

COUNTER MEASURES INC.

1889 YORK STREET
DENVER, COLORADO
303-333-7409

N/S STREET: CROWFOOT VALLEY RD
E/W STREET: PRADERA PKWY
CITY: PARKER
COUNTY: DOUGLAS

File Name : CROWPRAD
Site Code : 00000005
Start Date : 5/2/2017
Page No : 1

Groups Printed- VEHICLES

Start Time	CROWFOOT VALLEY RD Southbound				PRADERA PKWY Westbound				CROWFOOT VALLEY RD Northbound				Eastbound				Int. Total
	Left	Thru	Right	Peds	Left	Thru	Right	Peds	Left	Thru	Right	Peds	Left	Thru	Right	Peds	
Factor	1.0	1.0	1.0	1.0	1.0	1.0	1.0	1.0	1.0	1.0	1.0	1.0	1.0	1.0	1.0	1.0	
06:30 AM	2	36	0	0	20	0	11	0	0	43	9	0	0	0	0	0	121
06:45 AM	3	44	0	0	29	0	13	0	0	62	8	0	0	0	0	0	159
Total	5	80	0	0	49	0	24	0	0	105	17	0	0	0	0	0	280
07:00 AM	5	49	0	0	18	0	22	0	0	75	6	0	0	0	0	0	175
07:15 AM	3	69	0	0	25	0	26	0	0	91	4	0	0	0	0	0	218
07:30 AM	3	79	0	0	23	0	36	0	0	101	11	0	0	0	0	0	253
07:45 AM	9	77	0	0	32	0	33	0	0	81	14	0	0	0	0	0	246
Total	20	274	0	0	98	0	117	0	0	348	35	0	0	0	0	0	892
08:00 AM	13	56	0	0	26	0	28	0	0	116	5	0	0	0	0	0	244
08:15 AM	11	83	0	0	18	0	17	0	0	123	10	0	0	0	0	0	262
Total	24	139	0	0	44	0	45	0	0	239	15	0	0	0	0	0	506
04:00 PM	14	66	0	0	23	0	12	0	0	52	30	0	0	0	0	0	197
04:15 PM	25	78	0	0	15	0	10	0	0	74	21	0	0	0	0	0	223
04:30 PM	16	79	0	0	16	0	12	0	0	63	33	0	0	0	0	0	219
04:45 PM	8	73	0	0	12	0	9	0	0	76	19	0	0	0	0	0	197
Total	63	296	0	0	66	0	43	0	0	265	103	0	0	0	0	0	836
05:00 PM	20	65	0	0	15	0	12	0	0	67	22	0	0	0	0	0	201
05:15 PM	14	82	0	0	15	0	13	0	0	77	23	0	0	0	0	0	224
05:30 PM	24	61	0	0	20	0	7	0	0	52	24	0	0	0	0	0	188
05:45 PM	29	60	0	0	13	0	13	0	0	60	37	0	0	0	0	0	212
Total	87	268	0	0	63	0	45	0	0	256	106	0	0	0	0	0	825
Grand Total	199	1057	0	0	320	0	274	0	0	1213	276	0	0	0	0	0	3339
Apprch %	15.8	84.2	0.0	0.0	53.9	0.0	46.1	0.0	0.0	81.5	18.5	0.0	0.0	0.0	0.0	0.0	
Total %	6.0	31.7	0.0	0.0	9.6	0.0	8.2	0.0	0.0	36.3	8.3	0.0	0.0	0.0	0.0	0.0	

COUNTER MEASURES INC.

1889 YORK STREET
DENVER, COLORADO
303-333-7409

N/S STREET: CROWFOOT VALLEY RD
E/W STREET: PRADERA PKWY
CITY: PARKER
COUNTY: DOUGLAS

File Name : CROWPRAD
Site Code : 00000005
Start Date : 5/2/2017
Page No : 2

Start Time	CROWFOOT VALLEY RD Southbound					PRADERA PKWY Westbound					CROWFOOT VALLEY RD Northbound					Eastbound					Int. Total
	Left	Thru	Rig ht	Ped s	App. Total	Left	Thru	Rig ht	Ped s	App. Total	Left	Thru	Rig ht	Ped s	App. Total	Left	Thru	Rig ht	Ped s	App. Total	
Peak Hour From 07:00 AM to 07:45 AM - Peak 1 of 1																					
Intersection	07:00 AM																				
Volume	20	274	0	0	294	98	0	117	0	215	0	348	35	0	383	0	0	0	0	0	892
Percent	6.8	93.2	0.0	0.0		45.6	0.0	54.4	0.0		0.0	90.9	9.1	0.0		0.0	0.0	0.0	0.0		
07:30 Volume	3	79	0	0	82	23	0	36	0	59	0	101	11	0	112	0	0	0	0	0	253
Peak Factor	0.881																				
High Int. Volume	07:45 AM					07:45 AM					07:30 AM										
Peak Factor	9	77	0	0	86	32	0	33	0	65	0	101	11	0	112						
					0.855					0.827					0.855						

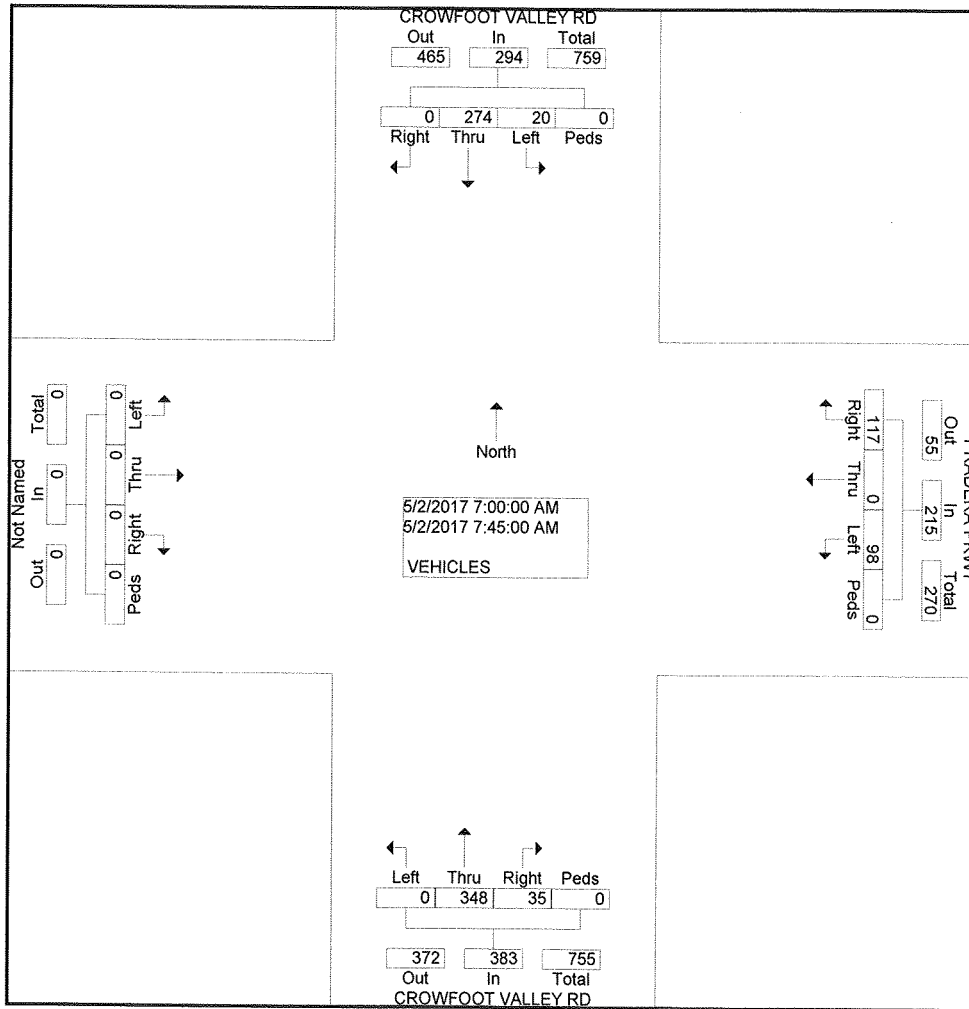

COUNTER MEASURES INC.

1889 YORK STREET
DENVER, COLORADO
303-333-7409

N/S STREET: CROWFOOT VALLEY RD
E/W STREET: PRADERA PKWY
CITY: PARKER
COUNTY: DOUGLAS

File Name : CROWPRAD
Site Code : 00000005
Start Date : 5/2/2017
Page No : 2

Start Time	CROWFOOT VALLEY RD Southbound					PRADERA PKWY Westbound					CROWFOOT VALLEY RD Northbound					Eastbound					Int. Total
	Left	Thru	Rig ht	Ped s	App. Total	Left	Thru	Rig ht	Ped s	App. Total	Left	Thru	Rig ht	Ped s	App. Total	Left	Thru	Rig ht	Ped s	App. Total	
Peak Hour From 04:45 PM to 05:30 PM - Peak 1 of 1																					
Intersecti on																					
04:45 PM	66	281	0	0	347	62	0	41	0	103	0	272	88	0	360	0	0	0	0	0	810
Volume	19.	81.	0.0	0.0		60.	0.0	39.	0.0		0.0	75.	24.	0.0		0.0	0.0	0.0	0.0		
Percent	0	0				2		8				6	4								
05:15	14	82	0	0	96	15	0	13	0	28	0	77	23	0	100	0	0	0	0	0	224
Volume																					
Peak																					
Factor																					
High Int.																					
05:15 PM	14	82	0	0	96	15	0	13	0	28	0	77	23	0	100	0	0	0	0	0	0.904
Volume																					
Peak																					
Factor																					

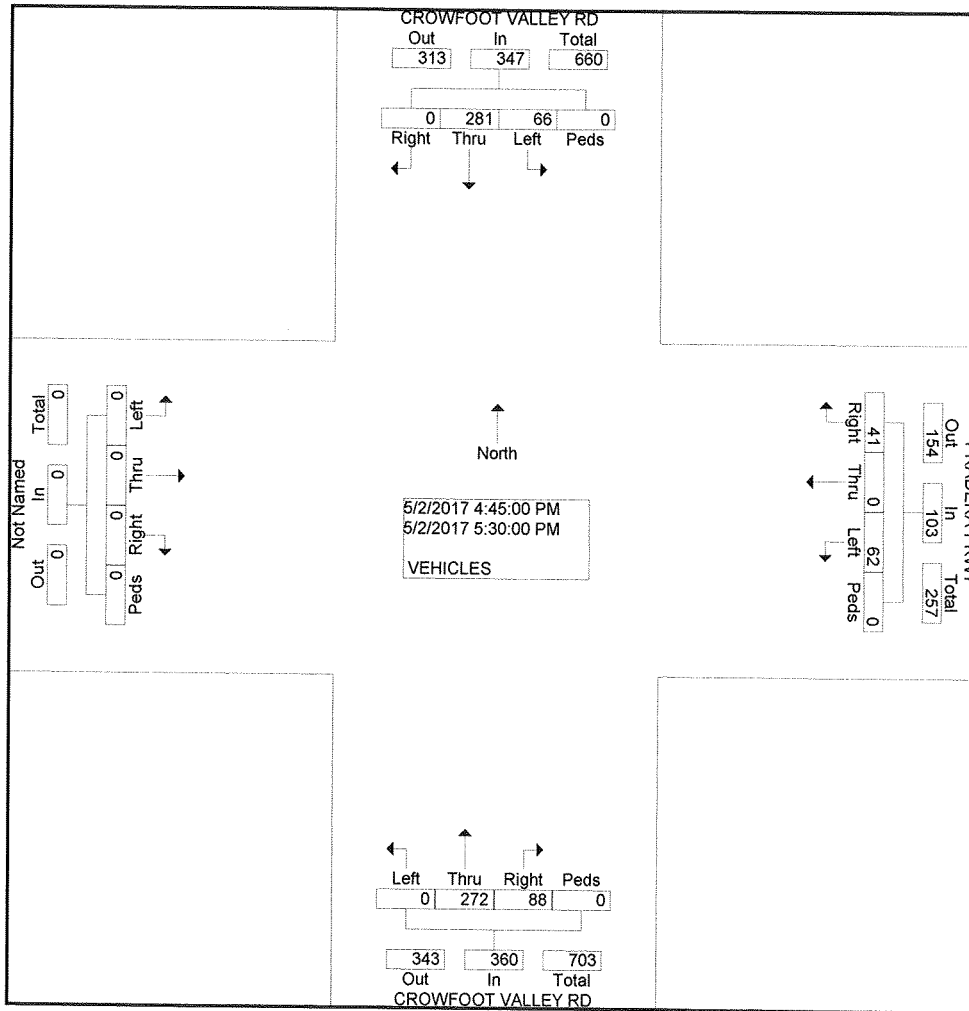

COUNTER MEASURES INC.

1889 YORK STREET
DENVER, COLORADO
303-333-7409

N/S STREET: PARKER RD
E/W STREET: STROH RD
CITY: PARKER
COUNTY: DOUGLAS

File Name : PARKSTROB
Site Code : 00000011
Start Date : 5/3/2017
Page No : 1

Groups Printed- 1 - VEHICLES

Start Time	PARKER RD Southbound				STROH RD Westbound				PARKER RD Northbound				STROH RD Eastbound				Int. Total
	Left	Thru	Right	Peds	Left	Thru	Right	Peds	Left	Thru	Right	Peds	Left	Thru	Right	Peds	
Factor	1.0	1.0	1.0	1.0	1.0	1.0	1.0	1.0	1.0	1.0	1.0	1.0	1.0	1.0	1.0	1.0	
06:30 AM	6	102	24	0	0	1	6	0	38	348	0	0	35	1	11	0	572
06:45 AM	6	141	15	0	0	2	1	0	33	419	1	0	41	2	15	0	676
Total	12	243	39	0	0	3	7	0	71	767	1	0	76	3	26	0	1248
07:00 AM	11	171	32	0	1	1	6	0	37	444	1	0	56	2	28	0	790
07:15 AM	7	156	37	1	0	2	4	0	51	553	3	0	47	5	28	0	894
07:30 AM	5	180	53	0	1	1	2	0	61	518	2	0	63	2	23	0	911
07:45 AM	8	182	32	0	2	0	9	0	51	476	2	0	58	0	28	0	848
Total	31	689	154	1	4	4	21	0	200	1991	8	0	224	9	107	0	3443
08:00 AM	3	165	28	0	0	1	9	0	44	437	3	0	72	3	21	0	786
08:15 AM	10	183	42	0	1	1	8	0	35	384	0	0	57	2	15	0	738
Total	13	348	70	0	1	2	17	0	79	821	3	0	129	5	36	0	1524
04:00 PM	7	389	45	1	0	0	4	0	57	285	1	0	54	12	57	1	913
04:15 PM	7	398	36	0	0	3	13	0	61	263	0	0	49	9	55	0	894
04:30 PM	7	404	41	0	3	3	2	0	38	225	2	0	64	4	58	0	851
04:45 PM	6	490	47	0	1	1	7	0	62	255	0	0	55	7	45	0	976
Total	27	1681	169	1	4	7	26	0	218	1028	3	0	222	32	215	1	3634
05:00 PM	5	412	37	0	0	1	8	0	38	227	1	1	69	15	64	0	878
05:15 PM	6	477	52	0	2	2	7	0	53	269	3	0	63	7	81	0	1022
05:30 PM	2	491	36	0	2	0	4	0	52	222	0	0	66	5	73	0	953
05:45 PM	5	426	57	0	0	1	4	0	51	255	0	0	42	3	68	0	912
Total	18	1806	182	0	4	4	23	0	194	973	4	1	240	30	286	0	3765
Grand Total	101	4767	614	2	13	20	94	0	762	5580	19	1	891	79	670	1	13614
Apprch %	1.8	86.9	11.2	0.0	10.2	15.7	74.0	0.0	12.0	87.7	0.3	0.0	54.3	4.8	40.8	0.1	
Total %	0.7	35.0	4.5	0.0	0.1	0.1	0.7	0.0	5.6	41.0	0.1	0.0	6.5	0.6	4.9	0.0	

COUNTER MEASURES INC.

1889 YORK STREET
DENVER, COLORADO
303-333-7409

N/S STREET: PARKER RD
E/W STREET: STROH RD
CITY: PARKER
COUNTY: DOUGLAS

File Name : PARKSTROB
Site Code : 0000011
Start Date : 5/3/2017
Page No : 2

Start Time	PARKER RD Southbound					STROH RD Westbound					PARKER RD Northbound					STROH RD Eastbound					Int. Total
	Left	Thru	Rig ht	Ped s	App. Total	Left	Thru	Rig ht	Ped s	App. Total	Left	Thru	Rig ht	Ped s	App. Total	Left	Thru	Rig ht	Ped s	App. Total	
Peak Hour From 06:30 AM to 08:30 AM - Peak 1 of 1																					
Intersecti on	07:00 AM																				
Volume	31	689	154	1	875	4	4	21	0	29	200	1991	8	0	2199	224	9	107	0	340	3443
Percent	3.5	78.7	17.6	0.1		13.8	13.8	72.4	0.0		9.1	90.5	0.4	0.0		65.9	2.6	31.5	0.0		
07:30 Volume Peak Factor	5	180	53	0	238	1	1	2	0	4	61	518	2	0	581	63	2	23	0	88	911
High Int. Peak Factor	07:30 AM					07:45 AM					07:15 AM					07:30 AM					
Volume	5	180	53	0	238	2	0	9	0	11	51	553	3	0	607	63	2	23	0	88	911
Peak Factor					0.919					0.659					0.906					0.966	0.945

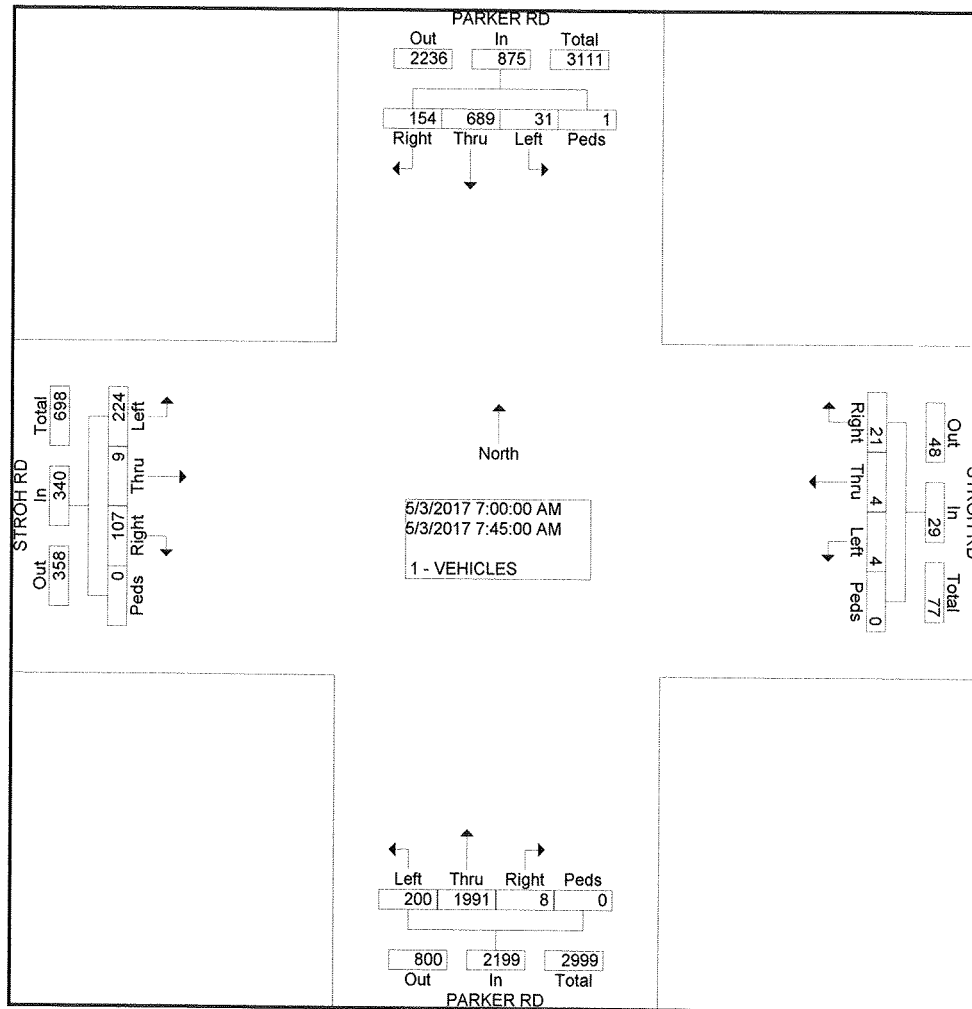

COUNTER MEASURES INC.

1889 YORK STREET
DENVER, COLORADO
303-333-7409

N/S STREET: PARKER RD
E/W STREET: STROH RD
CITY: PARKER
COUNTY: DOUGLAS

File Name : PARKSTROB
Site Code : 00000011
Start Date : 5/3/2017
Page No : 2

Start Time	PARKER RD Southbound					STROH RD Westbound					PARKER RD Northbound					STROH RD Eastbound					Int. Total
	Left	Thru	Rig ht	Ped s	App. Total	Left	Thru	Rig ht	Ped s	App. Total	Left	Thru	Rig ht	Ped s	App. Total	Left	Thru	Rig ht	Ped s	App. Total	
Peak Hour From 04:00 PM to 05:45 PM - Peak 1 of 1																					
Intersecti on	04:45 PM																				
Volume	19	1870	172	0	2061	5	4	26	0	35	205	973	4	1	1183	253	34	263	0	550	3829
Percent	0.9	90.7	8.3	0.0		14.3	11.4	74.3	0.0		17.3	82.2	0.3	0.1		46.0	6.2	47.8	0.0		
05:15 Volume Peak Factor	6	477	52	0	535	2	2	7	0	11	53	269	3	0	325	63	7	81	0	151	1022
High Int. Volume Peak Factor	04:45 PM					05:15 PM					05:15 PM					05:15 PM					
	6	490	47	0	543	2	2	7	0	11	53	269	3	0	325	63	7	81	0	151	0.937
					0.949					0.795					0.910					0.911	

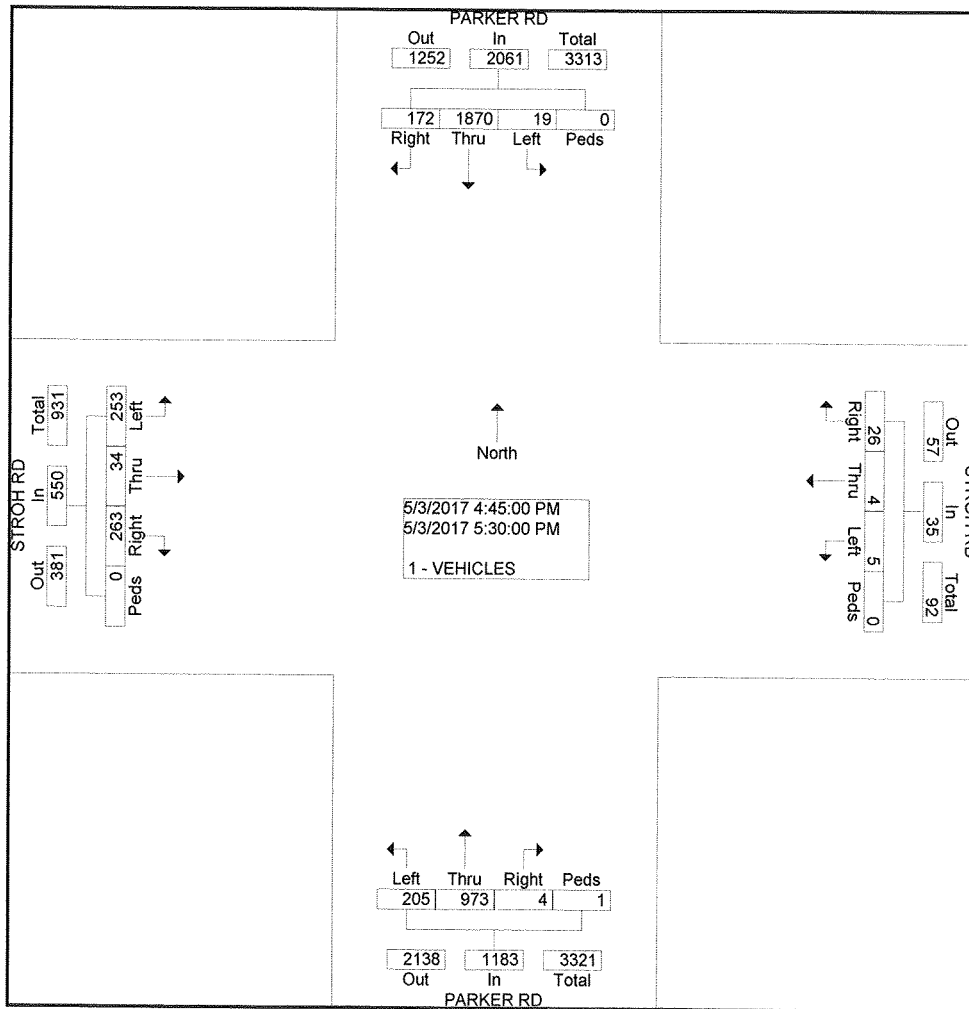

COUNTER MEASURES INC.

1889 YORK STREET
DENVER, COLORADO
303-333-7409

N/S STREET: PARKER RD
E/W STREET: N PINERY PKWY
CITY: PARKER
COUNTY: DOUGLAS

File Name : PARKNPIN
Site Code : 00000013
Start Date : 5/3/2017
Page No : 1

Groups Printed- VEHICLES

Start Time	PARKER RD Southbound				N PINERY PKWY Westbound				PARKER RD Northbound				N PINERY PKWY Eastbound				Int. Total
	Left	Thru	Right	Peds	Left	Thru	Right	Peds	Left	Thru	Right	Peds	Left	Thru	Right	Peds	
Factor	1.0	1.0	1.0	1.0	1.0	1.0	1.0	1.0	1.0	1.0	1.0	1.0	1.0	1.0	1.0	1.0	
06:30 AM	14	89	5	0	10	0	86	0	1	311	10	0	3	0	2	0	531
06:45 AM	13	131	4	0	10	0	96	0	2	324	8	0	10	1	1	0	600
Total	27	220	9	0	20	0	182	0	3	635	18	0	13	1	3	0	1131
07:00 AM	14	190	4	0	14	0	102	0	1	386	10	0	5	0	5	0	731
07:15 AM	24	179	2	0	16	1	87	0	3	507	13	0	3	1	3	0	839
07:30 AM	21	178	1	0	21	0	109	0	3	461	18	0	2	1	1	0	816
07:45 AM	39	194	2	0	26	0	103	0	0	393	29	0	2	0	2	0	790
Total	98	741	9	0	77	1	401	0	7	1747	70	0	12	2	11	0	3176
08:00 AM	37	143	4	0	23	1	103	0	2	366	14	0	9	0	2	0	704
08:15 AM	46	166	1	0	8	1	65	0	2	334	12	0	5	2	3	0	645
Total	83	309	5	0	31	2	168	0	4	700	26	0	14	2	5	0	1349
04:00 PM	97	375	6	0	55	1	114	0	2	197	11	0	2	0	3	0	863
04:15 PM	100	380	7	0	10	1	63	0	2	222	9	0	7	0	4	0	805
04:30 PM	107	377	11	0	9	0	57	0	0	187	8	0	3	2	2	0	763
04:45 PM	116	399	3	0	9	2	55	0	3	221	7	0	3	0	1	0	819
Total	420	1531	27	0	83	4	289	0	7	827	35	0	15	2	10	0	3250
05:00 PM	115	387	10	0	16	0	58	0	0	200	7	1	4	1	3	0	802
05:15 PM	113	455	4	0	16	0	61	0	0	223	7	0	2	2	0	0	883
05:30 PM	143	418	12	0	8	1	45	1	0	182	13	0	2	2	1	0	828
05:45 PM	138	375	5	0	10	0	46	0	1	230	16	0	0	0	1	0	822
Total	509	1635	31	0	50	1	210	1	1	835	43	1	8	5	5	0	3335
Grand Total	1137	4436	81	0	261	8	1250	1	22	4744	192	1	62	12	34	0	12241
Apprch %	20.1	78.5	1.4	0.0	17.2	0.5	82.2	0.1	0.4	95.7	3.9	0.0	57.4	11.1	31.5	0.0	
Total %	9.3	36.2	0.7	0.0	2.1	0.1	10.2	0.0	0.2	38.8	1.6	0.0	0.5	0.1	0.3	0.0	

COUNTER MEASURES INC.

1889 YORK STREET
DENVER, COLORADO
303-333-7409

N/S STREET: PARKER RD
E/W STREET: N PINERY PKWY
CITY: PARKER
COUNTY: DOUGLAS

File Name : PARKNPIN
Site Code : 0000013
Start Date : 5/3/2017
Page No : 2

Start Time	PARKER RD Southbound					N PINERY PKWY Westbound					PARKER RD Northbound					N PINERY PKWY Eastbound					Int. Total
	Left	Thru	Rght	Peds	App. Total	Left	Thru	Rght	Peds	App. Total	Left	Thru	Rght	Peds	App. Total	Left	Thru	Rght	Peds	App. Total	
Peak Hour From 06:30 AM to 08:30 AM - Peak 1 of 1																					
Intersecti on	07:00 AM																				
Volume	98	741	9	0	848	77	1	401	0	479	7	174	70	0	1824	12	2	11	0	25	3176
Percent	11.6	87.4	1.1	0.0		16.1	0.2	83.7	0.0		0.4	95.8	3.8	0.0		48.0	8.0	44.0	0.0		
07:15 Volume	24	179	2	0	205	16	1	87	0	104	3	507	13	0	523	3	1	3	0	7	839
Peak Factor	0.946																				
High Int. Volume	07:45 AM					07:30 AM					07:15 AM					07:00 AM					
Peak Factor	39	194	2	0	235	21	0	109	0	130	3	507	13	0	523	5	0	5	0	10	0.62
	0.90					0.92					0.87					0.62					5
	2					1					2					5					

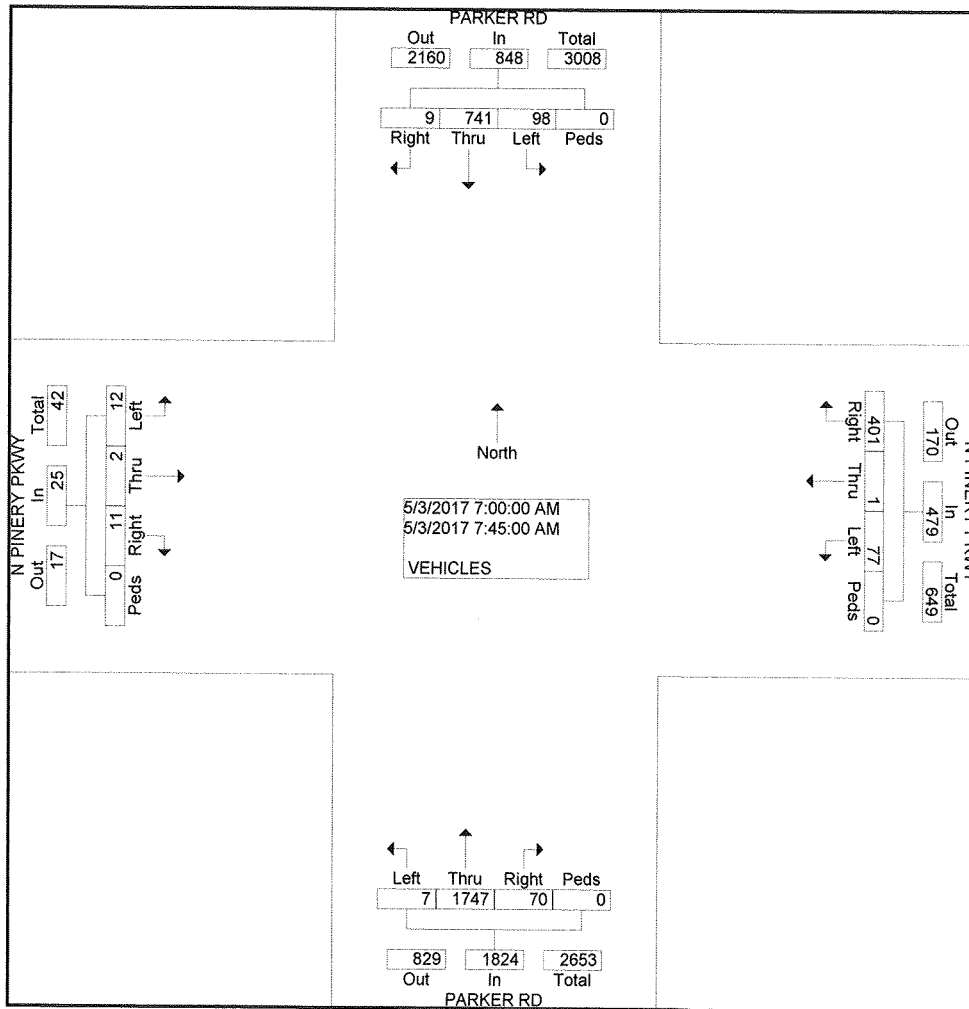

COUNTER MEASURES INC.

1889 YORK STREET
DENVER, COLORADO
303-333-7409

N/S STREET: PARKER RD
E/W STREET: N PINERY PKWY
CITY: PARKER
COUNTY: DOUGLAS

File Name : PARKNPIN
Site Code : 00000013
Start Date : 5/3/2017
Page No : 2

Start Time	PARKER RD Southbound					N PINERY PKWY Westbound					PARKER RD Northbound					N PINERY PKWY Eastbound					Int. Total		
	Left	Thru	Right	Peds	App. Total	Left	Thru	Right	Peds	App. Total	Left	Thru	Right	Peds	App. Total	Left	Thru	Right	Peds	App. Total			
Peak Hour From 04:45 PM to 05:30 PM - Peak 1 of 1																							
Intersection	04:45 PM																						
Volume	487	1659	29	0	2175	49	3	219	1	272	3	826	34	1	864	11	5	5	0	21	3332		
Percent	22.4	76.3	1.3	0.0		18.0	1.1	80.5	0.4		0.3	95.6	3.9	0.1		52.4	23.8	23.8	0.0				
05:15 Volume Peak Factor	113	455	4	0	572	16	0	61	0	77	0	223	7	0	230	2	2	0	0	4	883		
High Int. Volume Peak Factor	05:30 PM	143	418	12	0	573	05:15 PM	16	0	61	0	77	0.88	3	04:45 PM	3	221	7	0	231	0.93	5	
					0.94											05:00 PM	4	1	3	0	8	0.65	6

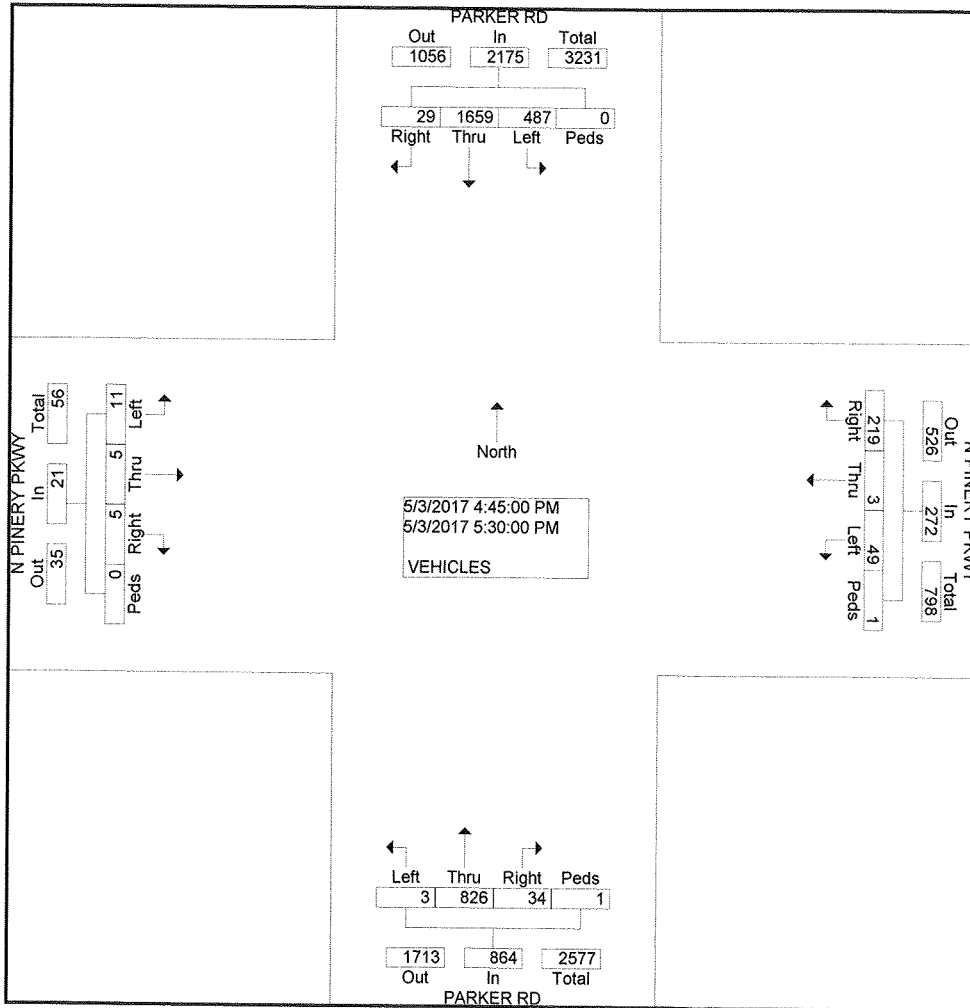

COUNTER MEASURES INC.

Location: PRADREA PKWY E/O CROWFOOT VALLEY RD **1889 YORK STREET**
 City: PARKER **DENVER, COLORADO 80206**
 County: DOUGLAS
 Direction: EASTBOUND-WESTBOUND **303-333-7409**

Site Code: 050204
 Station ID: 050204

Start Time	03-May-1 Wed	EB	WB	Total
12:00 AM		6	2	8
01:00		3	1	4
02:00		2	1	3
03:00		0	2	2
04:00		1	10	11
05:00		4	38	42
06:00		36	116	152
07:00		62	236	298
08:00		106	183	289
09:00		91	112	203
10:00		66	112	178
11:00		78	82	160
12:00 PM		74	104	178
01:00		76	89	165
02:00		101	98	199
03:00		165	133	298
04:00		178	116	294
05:00		180	105	285
06:00		160	86	246
07:00		117	46	163
08:00		82	50	132
09:00		70	30	100
10:00		36	8	44
11:00		9	0	9
Total		1703	1760	3463
Percent		49.2%	50.8%	
AM Peak	-	08:00	07:00	07:00
Vol.	-	106	236	298
PM Peak	-	17:00	15:00	15:00
Vol.	-	180	133	298
Grand Total		1703	1760	3463
Percent		49.2%	50.8%	
ADT		ADT 3,463	AADT 3,463	

COUNTER MEASURES INC.

Location: CROWFOOT VALLEY RD S/O PRADERA PKWY **1889 YORK STREET**
 City: PARKER **DENVER, COLORADO 80206**
 County: DOUGLAS **303-333-7409**
 Direction: SOUTHBOUND-NORTHBOUND

Site Code: 050201
 Station ID: 050201

Start Time	03-May-1 Wed	SB	NB						Total
12:00 AM		6	8						14
01:00		5	5						10
02:00		2	0						2
03:00		10	4						14
04:00		18	10						28
05:00		84	49						133
06:00		216	186						402
07:00		390	395						785
08:00		390	474						864
09:00		236	268						504
10:00		225	214						439
11:00		214	196						410
12:00 PM		238	186						424
01:00		232	224						456
02:00		229	260						489
03:00		336	298						634
04:00		363	360						723
05:00		340	360						700
06:00		244	263						507
07:00		159	199						358
08:00		114	130						244
09:00		82	90						172
10:00		48	48						96
11:00		16	18						34
Total		4197	4245						8442
Percent		49.7%	50.3%						
AM Peak	-	07:00	08:00	-	-	-	-	-	08:00
Vol.	-	390	474	-	-	-	-	-	864
PM Peak	-	16:00	16:00	-	-	-	-	-	16:00
Vol.	-	363	360	-	-	-	-	-	723
Grand Total		4197	4245						8442
Percent		49.7%	50.3%						
ADT		ADT 8,442	AADT 8,442						

COUNTER MEASURES INC.

Location: CROWFOOT VALLEY RD S/O STRON RD
 City: PARKER
 County: DOUGLAS
 Direction: SOUTHBOUND-NORTHBOUND

1889 YORK STREET
 DENVER, COLORADO 80206
 303-333-7409

Site Code: 050206
 Station ID: 050206

Start Time	03-May-1 Wed	SB	NB	Total
12:00 AM		5	4	9
01:00		5	2	7
02:00		3	2	5
03:00		8	4	12
04:00		16	16	32
05:00		60	52	112
06:00		149	172	321
07:00		309	484	793
08:00		332	528	860
09:00		210	288	498
10:00		172	210	382
11:00		194	188	382
12:00 PM		201	192	393
01:00		200	197	397
02:00		206	214	420
03:00		332	262	594
04:00		362	301	663
05:00		363	304	667
06:00		250	198	448
07:00		169	156	325
08:00		118	101	219
09:00		85	60	145
10:00		52	32	84
11:00		20	14	34
Total		3821	3981	7802
Percent		49.0%	51.0%	
AM Peak	-	08:00	08:00	08:00
Vol.	-	332	528	860
PM Peak	-	17:00	17:00	17:00
Vol.	-	363	304	667
Grand Total		3821	3981	7802
Percent		49.0%	51.0%	
ADT		ADT 7,802	AADT 7,802	

COUNTER MEASURES INC.

Location: STROH RD E/O CROWFOOT VALLEY RD
 City: PARKER
 County: DOUGLAS
 Direction: WESTBOUND-EASTBOUND

1889 YORK STREET
 DENVER, COLORADO 80206
 303-333-7409

Site Code: 050203
 Station ID: 050203

Start Time	03-May-1 Wed	WB	EB	Total
12:00 AM		6	9	15
01:00		5	4	9
02:00		2	3	5
03:00		10	4	14
04:00		14	12	26
05:00		61	32	93
06:00		174	110	284
07:00		365	290	655
08:00		296	290	586
09:00		250	276	526
10:00		179	166	345
11:00		200	213	413
12:00 PM		218	206	424
01:00		188	214	402
02:00		200	232	432
03:00		285	316	601
04:00		278	446	724
05:00		330	456	786
06:00		230	303	533
07:00		150	207	357
08:00		133	135	268
09:00		82	86	168
10:00		33	32	65
11:00		16	12	28
Total		3705	4054	7759
Percent		47.8%	52.2%	
AM Peak	-	07:00	07:00	07:00
Vol.	-	365	290	655
PM Peak	-	17:00	17:00	17:00
Vol.	-	330	456	786
Grand Total		3705	4054	7759
Percent		47.8%	52.2%	
ADT		ADT 7,759	AADT 7,759	

COUNTER MEASURES INC.

Location: MOTSENBOCKER RD N/O STROH RD
 City: PARKER
 County: DOUGLAS
 Direction: SOUTHBOUND-NORTHBOUND

1889 YORK STREET
 DENVER, COLORADO 80206
 303-333-7409

Site Code: 050209
 Station ID: 050209

Start Time	03-May-1 Wed	SB	NB							Total
12:00 AM		8	6							14
01:00		2	1							3
02:00		4	2							6
03:00		2	4							6
04:00		8	9							17
05:00		24	48							72
06:00		90	172							262
07:00		232	472							704
08:00		250	452							702
09:00		183	262							445
10:00		124	182							306
11:00		170	164							334
12:00 PM		161	185							346
01:00		149	170							319
02:00		205	170							375
03:00		362	257							619
04:00		480	250							730
05:00		448	251							699
06:00		306	190							496
07:00		212	152							364
08:00		124	106							230
09:00		76	53							129
10:00		39	28							67
11:00		12	10							22
Total		3671	3596							7267
Percent		50.5%	49.5%							
AM Peak	-	08:00	07:00	-	-	-	-	-	-	07:00
Vol.	-	250	472	-	-	-	-	-	-	704
PM Peak	-	16:00	15:00	-	-	-	-	-	-	16:00
Vol.	-	480	257	-	-	-	-	-	-	730
Grand Total		3671	3596							7267
Percent		50.5%	49.5%							
ADT		ADT 7,267	AADT 7,267							

LEVEL OF SERVICE DEFINITIONS

From *Highway Capacity Manual*, Transportation Research Board, 2010

SIGNALIZED INTERSECTION LEVEL OF SERVICE (LOS)

<u>LOS</u>	<u>Average Vehicle Delay</u> sec/vehicle	<u>Operational Characteristics</u>
A	<10 seconds	Describes operations with low control delay, up to 10 sec/veh. This LOS occurs when progression is extremely favorable and most vehicles arrive during the green phase. Many vehicles do not stop at all. Short cycle lengths may tend to contribute to low delay values.
B	10 to 20 seconds	Describes operations with control delay greater than 10 seconds and up to 20 sec/veh. This level generally occurs with good progression, short cycle lengths, or both. More vehicles stop than with LOS A, causing higher levels of delay.
C	20 to 35 seconds	Describes operations with control delay greater than 20 and up to 35 sec/veh. These higher delays may result from only fair progression, longer cycle length, or both. Individual cycle failures may begin to appear at this level. Cycle failure occurs when a given green phase does not serve queued vehicles, and overflows occur. The number of vehicles stopping is significant at this level, though many still pass through the intersection without stopping.
D	35 to 55 seconds	Describes operations with control delay greater than 35 and up to 55 sec/veh. At LOS D, the influence of congestion becomes more noticeable. Longer delays may result from some combination of unfavorable progression, long cycle lengths, and high v/c ratios. Many vehicles stop, and the proportion of vehicles not stopping declines. Individual cycle failures are noticeable.
E	55 to 80 seconds	Describes operations with control delay greater than 55 and up to 80 sec/veh. These high delay values generally indicate poor progression, long cycle lengths, and high v/c ratios. Individual cycle failures are frequent.
F	>80 seconds	Describes operations with control delay in excess of 80 sec/veh. This level, considered unacceptable to most drivers, often occurs with over-saturation, that is, when arrival flow rates exceed the capacity of lane groups. It may also occur at high v/c ratios with many individual cycle failures. Poor progression and long cycle lengths may also contribute significantly to high delay levels.

LEVEL OF SERVICE DEFINITIONS

From *Highway Capacity Manual*, Transportation Research Board, 2010

UNSIGNALIZED INTERSECTION LEVEL OF SERVICE (LOS)

Applicable to Two-Way Stop Control, All-Way Stop Control, and Roundabouts

LOS	Average Vehicle Control Delay	<u>Operational Characteristics</u>
A	<10 seconds	Normally, vehicles on the stop-controlled approach only have to wait up to 10 seconds before being able to clear the intersection. Left-turning vehicles on the uncontrolled street do not have to wait to make their turn.
B	10 to 15 seconds	Vehicles on the stop-controlled approach will experience delays before being able to clear the intersection. <u>The delay could be up to 15 seconds.</u> Left-turning vehicles on the uncontrolled street may have to wait to make their turn.
C	15 to 25 seconds	Vehicles on the stop-controlled approach can expect delays in the range of 15 to 25 seconds before clearing the intersection. Motorists may begin to take chances due to the long delays, thereby posing a safety risk to through traffic. <u>Left-turning vehicles on the uncontrolled street will now be required to wait to make their turn causing a queue to be created in the turn lane.</u>
D	25 to 35 seconds	<u>This is the point at which a traffic signal may be warranted for this intersection.</u> The delays for the stop-controlled intersection are not considered to be excessive. The length of the queue may begin to block other public and private access points.
E	35 to 50 seconds	The delays for all critical traffic movements are considered to be unacceptable. The length of the queues for the stop-controlled approaches as well as the left-turn movements are extremely long. <u>There is a high probability that this intersection will meet traffic signal warrants.</u> The ability to install a traffic signal is affected by the location of other existing traffic signals. Consideration may be given to restricting the accesses by eliminating the left-turn movements from and to the stop-controlled approach.
F	>50 seconds	The delay for the critical traffic movements are probably in excess of 100 seconds. The length of the queues are extremely long. Motorists are selecting alternative routes due to the long delays. <u>The only remedy for these long delays is installing a traffic signal or restricting the accesses.</u> The potential for accidents at this intersection are extremely high due to motorist taking more risky chances. If the median permits, motorists begin making two-stage left-turns.

HCM 6th Signalized Intersection Summary
 2: Crowfoot Valley Rd/Motsenbocker Rd & Stroh Rd

Existing Traffic
 AM Peak Hour



Movement	WBL	WBR	NBT	NBR	SBL	SBT
Lane Configurations						
Traffic Volume (veh/h)	201	190	250	146	128	132
Future Volume (veh/h)	201	190	250	146	128	132
Initial Q (Qb), veh	0	0	0	0	0	0
Ped-Bike Adj(A_pbT)	1.00	1.00		1.00	1.00	
Parking Bus, Adj	1.00	1.00	1.00	1.00	1.00	1.00
Work Zone On Approach	No		No			No
Adj Sat Flow, veh/h/ln	1870	1870	1870	1870	1870	1870
Adj Flow Rate, veh/h	234	221	291	170	149	143
Peak Hour Factor	0.86	0.86	0.86	0.86	0.86	0.92
Percent Heavy Veh, %	2	2	2	2	2	2
Cap, veh/h	317	282	927	785	631	1225
Arrive On Green	0.18	0.18	0.50	0.50	0.08	0.66
Sat Flow, veh/h	1781	1585	1870	1585	1781	1870
Grp Volume(v), veh/h	234	221	291	170	149	143
Grp Sat Flow(s),veh/h/ln	1781	1585	1870	1585	1781	1870
Q Serve(g_s), s	7.5	8.0	5.6	3.6	2.2	1.7
Cycle Q Clear(g_c), s	7.5	8.0	5.6	3.6	2.2	1.7
Prop In Lane	1.00	1.00		1.00	1.00	
Lane Grp Cap(c), veh/h	317	282	927	785	631	1225
V/C Ratio(X)	0.74	0.78	0.31	0.22	0.24	0.12
Avail Cap(c_a), veh/h	445	396	927	785	643	1225
HCM Platoon Ratio	1.00	1.00	1.00	1.00	1.00	1.00
Upstream Filter(I)	1.00	1.00	1.00	1.00	1.00	1.00
Uniform Delay (d), s/veh	23.3	23.5	9.0	8.6	5.7	3.9
Incr Delay (d2), s/veh	3.9	6.6	0.9	0.6	0.2	0.2
Initial Q Delay(d3),s/veh	0.0	0.0	0.0	0.0	0.0	0.0
%ile BackOfQ(50%),veh/ln	3.1	0.5	2.1	1.1	0.6	0.5
Unsig. Movement Delay, s/veh						
LnGrp Delay(d),s/veh	27.3	30.1	9.9	9.2	5.9	4.1
LnGrp LOS	C	C	A	A	A	A
Approach Vol, veh/h	455		461			292
Approach Delay, s/veh	28.7		9.7			5.0
Approach LOS	C		A			A
Timer - Assigned Phs	1	2			6	8
Phs Duration (G+Y+Rc), s	9.6	34.7			44.3	15.7
Change Period (Y+Rc), s	5.0	5.0			5.0	5.0
Max Green Setting (Gmax), s	5.0	25.0			35.0	15.0
Max Q Clear Time (g_c+I1), s	4.2	7.6			3.7	10.0
Green Ext Time (p_c), s	0.0	2.0			0.8	0.7

Intersection Summary

HCM 6th Ctrl Delay			15.7			
HCM 6th LOS			B			

HCM 6th TWSC
5: Crowfoot Valley Rd & Pradera Pkwy

Existing Traffic
AM Peak Hour

Intersection						
Int Delay, s/veh	3.4					
Movement	WBL	WBR	NBT	NBR	SBL	SBT
Lane Configurations	↘	↗	↑	↗	↘	↑
Traffic Vol, veh/h	98	117	348	35	20	274
Future Vol, veh/h	98	117	348	35	20	274
Conflicting Peds, #/hr	0	0	0	0	0	0
Sign Control	Stop	Stop	Free	Free	Free	Free
RT Channelized	-	None	-	None	-	None
Storage Length	230	0	-	350	350	-
Veh in Median Storage, #	0	-	0	-	-	0
Grade, %	0	-	0	-	-	0
Peak Hour Factor	88	88	88	88	88	88
Heavy Vehicles, %	2	2	2	2	2	2
Mvmt Flow	111	133	395	40	23	311

Major/Minor	Minor1	Major1	Major2			
Conflicting Flow All	752	395	0	0	435	0
Stage 1	395	-	-	-	-	-
Stage 2	357	-	-	-	-	-
Critical Hdwy	6.42	6.22	-	-	4.12	-
Critical Hdwy Stg 1	5.42	-	-	-	-	-
Critical Hdwy Stg 2	5.42	-	-	-	-	-
Follow-up Hdwy	3.518	3.318	-	-	2.218	-
Pot Cap-1 Maneuver	378	654	-	-	1125	-
Stage 1	681	-	-	-	-	-
Stage 2	708	-	-	-	-	-
Platoon blocked, %			-	-		
Mov Cap-1 Maneuver	370	654	-	-	1125	-
Mov Cap-2 Maneuver	477	-	-	-	-	-
Stage 1	667	-	-	-	-	-
Stage 2	708	-	-	-	-	-

































Approach	WB	NB	SB
HCM Control Delay, s	13.2	0	0.6
HCM LOS	B		

Minor Lane/Major Mvmt	NBT	NBRWBLn1	WBLn2	SBL	SBT
Capacity (veh/h)	-	-	477	654	1125
HCM Lane V/C Ratio	-	-	0.233	0.203	0.02
HCM Control Delay (s)	-	-	14.8	11.9	8.3
HCM Lane LOS	-	-	B	B	A
HCM 95th %tile Q(veh)	-	-	0.9	0.8	0.1

HCM 6th Signalized Intersection Summary

7: Parker Rd & Pinery Pkwy

Existing Traffic
AM Peak Hour

												
Movement	EBL	EBT	EBR	WBL	WBT	WBR	NBL	NBT	NBR	SBL	SBT	SBR
Lane Configurations	 		 	 			 	  		 	  	 
Traffic Volume (veh/h)	12	2	11	77	1	401	7	1747	70	98	741	9
Future Volume (veh/h)	12	2	11	77	1	401	7	1747	70	98	741	9
Initial Q (Qb), veh	0	0	0	0	0	0	0	0	0	0	0	0
Ped-Bike Adj(A_pbT)	1.00		1.00	1.00		1.00	1.00		1.00	1.00		1.00
Parking Bus, Adj	1.00	1.00	1.00	1.00	1.00	1.00	1.00	1.00	1.00	1.00	1.00	1.00
Work Zone On Approach		No			No			No			No	
Adj Sat Flow, veh/h/ln	1870	1870	1870	1870	1870	1870	1870	1870	1870	1870	1870	1870
Adj Flow Rate, veh/h	13	2	0	81	1	422	7	1839	74	103	780	0
Peak Hour Factor	0.95	0.95	0.95	0.95	0.95	0.95	0.95	0.95	0.95	0.95	0.95	0.95
Percent Heavy Veh, %	2	2	2	2	2	2	2	2	2	2	2	2
Cap, veh/h	51	477		501	1	446	15	2409	97	144	2611	
Arrive On Green	0.01	0.26	0.00	0.05	0.28	0.28	0.01	0.48	0.48	0.04	0.51	0.00
Sat Flow, veh/h	3456	1870	1585	1781	4	1582	1781	5036	202	3456	5106	1585
Grp Volume(v), veh/h	13	2	0	81	0	423	7	1242	671	103	780	0
Grp Sat Flow(s),veh/h/ln	1728	1870	1585	1781	0	1586	1781	1702	1834	1728	1702	1585
Q Serve(g_s), s	0.4	0.1	0.0	4.0	0.0	31.3	0.5	36.0	36.1	3.5	10.6	0.0
Cycle Q Clear(g_c), s	0.4	0.1	0.0	4.0	0.0	31.3	0.5	36.0	36.1	3.5	10.6	0.0
Prop In Lane	1.00		1.00	1.00		1.00	1.00		0.11	1.00		1.00
Lane Grp Cap(c), veh/h	51	477		501	0	447	15	1628	877	144	2611	
V/C Ratio(X)	0.26	0.00		0.16	0.00	0.95	0.45	0.76	0.76	0.72	0.30	
Avail Cap(c_a), veh/h	144	546		501	0	462	74	1628	877	144	2611	
HCM Platoon Ratio	1.00	1.00	1.00	1.00	1.00	1.00	1.00	1.00	1.00	1.00	1.00	1.00
Upstream Filter(I)	1.00	1.00	0.00	1.00	0.00	1.00	1.00	1.00	1.00	0.98	0.98	0.00
Uniform Delay (d), s/veh	58.5	33.3	0.0	30.2	0.0	42.2	59.2	25.7	25.7	56.8	16.9	0.0
Incr Delay (d2), s/veh	2.6	0.0	0.0	0.1	0.0	28.2	19.3	3.4	6.3	15.2	0.3	0.0
Initial Q Delay(d3),s/veh	0.0	0.0	0.0	0.0	0.0	0.0	0.0	0.0	0.0	0.0	0.0	0.0
%ile BackOfQ(50%),veh/ln	0.2	0.0	0.0	1.7	0.0	15.8	0.3	13.9	15.7	1.8	3.8	0.0
Unsig. Movement Delay, s/veh												
LnGrp Delay(d),s/veh	61.1	33.3	0.0	30.3	0.0	70.4	78.5	29.2	32.0	72.0	17.2	0.0
LnGrp LOS	E	C		C	A	E	E	C	C	E	B	
Approach Vol, veh/h		15	A		504			1920			883	A
Approach Delay, s/veh		57.4			64.0			30.3			23.6	
Approach LOS		E			E			C			C	
Timer - Assigned Phs	1	2	3	4	5	6	7	8				
Phs Duration (G+Y+Rc), s	10.0	64.4	10.0	35.6	6.0	68.4	6.8	38.8				
Change Period (Y+Rc), s	5.0	7.0	4.5	5.0	5.0	7.0	5.0	5.0				
Max Green Setting (Gmax), s	5.0	53.0	5.5	35.0	5.0	53.0	5.0	35.0				
Max Q Clear Time (g_c+I1), s	5.5	38.1	6.0	2.1	2.5	12.6	2.4	33.3				
Green Ext Time (p_c), s	0.0	9.9	0.0	0.0	0.0	5.2	0.0	0.5				

Intersection Summary

HCM 6th Ctrl Delay	33.8
HCM 6th LOS	C

Notes

Unsignalized Delay for [EBR, SBR] is excluded from calculations of the approach delay and intersection delay.

HCM 6th Signalized Intersection Summary
 2: Crowfoot Valley Rd/Motsenbocker Rd & Stroh Rd

Existing Traffic
 PM Peak Hour



Movement	WBL	WBR	NBT	NBR	SBL	SBT
Lane Configurations						
Traffic Volume (veh/h)	212	129	142	166	311	170
Future Volume (veh/h)	212	129	142	166	311	170
Initial Q (Qb), veh	0	0	0	0	0	0
Ped-Bike Adj(A_pbT)	1.00	1.00		1.00	1.00	
Parking Bus, Adj	1.00	1.00	1.00	1.00	1.00	1.00
Work Zone On Approach	No		No			No
Adj Sat Flow, veh/h/ln	1870	1870	1870	1870	1870	1870
Adj Flow Rate, veh/h	230	140	154	180	338	185
Peak Hour Factor	0.92	0.92	0.92	0.92	0.92	0.92
Percent Heavy Veh, %	2	2	2	2	2	2
Cap, veh/h	296	264	936	793	745	1248
Arrive On Green	0.17	0.17	0.50	0.50	0.08	0.67
Sat Flow, veh/h	1781	1585	1870	1585	1781	1870
Grp Volume(v), veh/h	230	140	154	180	338	185
Grp Sat Flow(s),veh/h/ln	1781	1585	1870	1585	1781	1870
Q Serve(g_s), s	7.4	4.8	2.7	3.8	5.0	2.2
Cycle Q Clear(g_c), s	7.4	4.8	2.7	3.8	5.0	2.2
Prop In Lane	1.00	1.00		1.00	1.00	
Lane Grp Cap(c), veh/h	296	264	936	793	745	1248
V/C Ratio(X)	0.78	0.53	0.16	0.23	0.45	0.15
Avail Cap(c_a), veh/h	445	396	936	793	745	1248
HCM Platoon Ratio	1.00	1.00	1.00	1.00	1.00	1.00
Upstream Filter(I)	1.00	1.00	1.00	1.00	1.00	1.00
Uniform Delay (d), s/veh	23.9	22.9	8.2	8.4	5.9	3.7
Incr Delay (d2), s/veh	4.9	1.7	0.4	0.7	0.4	0.3
Initial Q Delay(d3),s/veh	0.0	0.0	0.0	0.0	0.0	0.0
%ile BackOfQ(50%),veh/ln	3.2	1.7	1.0	1.2	1.4	0.6
Unsig. Movement Delay, s/veh						
LnGrp Delay(d),s/veh	28.8	24.5	8.5	9.1	6.3	3.9
LnGrp LOS	C	C	A	A	A	A
Approach Vol, veh/h	370		334			523
Approach Delay, s/veh	27.2		8.8			5.5
Approach LOS	C		A			A
Timer - Assigned Phs	1	2			6	8
Phs Duration (G+Y+Rc), s	10.0	35.0			45.0	15.0
Change Period (Y+Rc), s	5.0	5.0			5.0	5.0
Max Green Setting (Gmax), s	5.0	25.0			35.0	15.0
Max Q Clear Time (g_c+I1), s	7.0	5.8			4.2	9.4
Green Ext Time (p_c), s	0.0	1.3			1.0	0.6

Intersection Summary

HCM 6th Ctrl Delay			12.9			
HCM 6th LOS			B			

Intersection						
Int Delay, s/veh	2.3					
Movement	WBL	WBR	NBT	NBR	SBL	SBT
Lane Configurations	↘	↗	↑	↗	↘	↑
Traffic Vol, veh/h	62	41	272	88	66	281
Future Vol, veh/h	62	41	272	88	66	281
Conflicting Peds, #/hr	0	0	0	0	0	0
Sign Control	Stop	Stop	Free	Free	Free	Free
RT Channelized	-	None	-	None	-	None
Storage Length	230	0	-	350	350	-
Veh in Median Storage, #	0	-	0	-	-	0
Grade, %	0	-	0	-	-	0
Peak Hour Factor	90	90	90	90	90	90
Heavy Vehicles, %	2	2	2	2	2	2
Mvmt Flow	69	46	302	98	73	312

Major/Minor	Minor1	Major1	Major2			
Conflicting Flow All	760	302	0	0	400	0
Stage 1	302	-	-	-	-	-
Stage 2	458	-	-	-	-	-
Critical Hdwy	6.42	6.22	-	-	4.12	-
Critical Hdwy Stg 1	5.42	-	-	-	-	-
Critical Hdwy Stg 2	5.42	-	-	-	-	-
Follow-up Hdwy	3.518	3.318	-	-	2.218	-
Pot Cap-1 Maneuver	374	738	-	-	1159	-
Stage 1	750	-	-	-	-	-
Stage 2	637	-	-	-	-	-
Platoon blocked, %			-	-		
Mov Cap-1 Maneuver	350	738	-	-	1159	-
Mov Cap-2 Maneuver	441	-	-	-	-	-
Stage 1	703	-	-	-	-	-
Stage 2	637	-	-	-	-	-

Approach	WB	NB	SB
HCM Control Delay, s	12.9	0	1.6
HCM LOS	B		

Minor Lane/Major Mvmt	NBT	NBRWBLn1	WBLn2	SBL	SBT
Capacity (veh/h)	-	-	441	738	1159
HCM Lane V/C Ratio	-	-	0.156	0.062	0.063
HCM Control Delay (s)	-	-	14.7	10.2	8.3
HCM Lane LOS	-	-	B	B	A
HCM 95th %tile Q(veh)	-	-	0.5	0.2	0.2

HCM 6th Signalized Intersection Summary
7: Parker Rd & Pinery Pkwy

Existing Traffic
PM Peak Hour

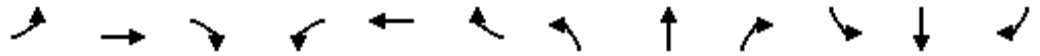

Movement	EBL	EBT	EBR	WBL	WBT	WBR	NBL	NBT	NBR	SBL	SBT	SBR
Lane Configurations	↖↗	↑	↖	↖	↖		↖	↑↑↑		↖↗	↑↑↑	↖
Traffic Volume (veh/h)	11	5	5	49	3	219	3	826	34	487	1659	29
Future Volume (veh/h)	11	5	5	49	3	219	3	826	34	487	1659	29
Initial Q (Qb), veh	0	0	0	0	0	0	0	0	0	0	0	0
Ped-Bike Adj(A_pbT)	1.00		1.00	1.00		1.00	1.00		1.00	1.00		1.00
Parking Bus, Adj	1.00	1.00	1.00	1.00	1.00	1.00	1.00	1.00	1.00	1.00	1.00	1.00
Work Zone On Approach		No			No			No			No	
Adj Sat Flow, veh/h/ln	1870	1870	1870	1870	1870	1870	1870	1870	1870	1870	1870	1870
Adj Flow Rate, veh/h	12	5	0	52	3	233	3	879	36	518	1765	0
Peak Hour Factor	0.94	0.94	0.94	0.94	0.94	0.94	0.94	0.94	0.94	0.94	0.94	0.94
Percent Heavy Veh, %	2	2	2	2	2	2	2	2	2	2	2	2
Cap, veh/h	47	226		289	3	222	7	2492	102	603	3399	
Arrive On Green	0.01	0.12	0.00	0.03	0.14	0.14	0.00	0.50	0.50	0.17	0.67	0.00
Sat Flow, veh/h	3456	1870	1585	1781	20	1568	1781	5032	206	3456	5106	1585
Grp Volume(v), veh/h	12	5	0	52	0	236	3	594	321	518	1765	0
Grp Sat Flow(s),veh/h/ln	1728	1870	1585	1781	0	1588	1781	1702	1833	1728	1702	1585
Q Serve(g_s), s	0.4	0.3	0.0	3.0	0.0	17.0	0.2	12.8	12.9	17.5	21.2	0.0
Cycle Q Clear(g_c), s	0.4	0.3	0.0	3.0	0.0	17.0	0.2	12.8	12.9	17.5	21.2	0.0
Prop In Lane	1.00		1.00	1.00		0.99	1.00		0.11	1.00		1.00
Lane Grp Cap(c), veh/h	47	226		289	0	225	7	1686	908	603	3399	
V/C Ratio(X)	0.25	0.02		0.18	0.00	1.05	0.42	0.35	0.35	0.86	0.52	
Avail Cap(c_a), veh/h	158	265		309	0	225	82	1686	908	907	3399	
HCM Platoon Ratio	1.00	1.00	1.00	1.00	1.00	1.00	1.00	1.00	1.00	1.00	1.00	1.00
Upstream Filter(l)	1.00	1.00	0.00	1.00	0.00	1.00	1.00	1.00	1.00	0.72	0.72	0.00
Uniform Delay (d), s/veh	58.6	46.5	0.0	44.1	0.0	51.5	59.6	18.5	18.5	48.1	10.3	0.0
Incr Delay (d2), s/veh	2.7	0.0	0.0	0.3	0.0	73.4	35.7	0.6	1.1	4.1	0.4	0.0
Initial Q Delay(d3),s/veh	0.0	0.0	0.0	0.0	0.0	0.0	0.0	0.0	0.0	0.0	0.0	0.0
%ile BackOfQ(50%),veh/ln	0.2	0.1	0.0	1.4	0.0	11.4	0.2	4.7	5.3	7.5	6.6	0.0
Unsig. Movement Delay, s/veh												
LnGrp Delay(d),s/veh	61.3	46.5	0.0	44.4	0.0	124.9	95.4	19.1	19.6	52.2	10.7	0.0
LnGrp LOS	E	D		D	A	F	F	B	B	D	B	
Approach Vol, veh/h		17	A		288			918			2283	A
Approach Delay, s/veh		57.0			110.4			19.5			20.1	
Approach LOS		E			F			B			C	
Timer - Assigned Phs	1	2	3	4	5	6	7	8				
Phs Duration (G+Y+Rc), s	25.4	66.4	8.7	19.5	5.0	86.9	6.1	22.0				
Change Period (Y+Rc), s	4.5	7.0	4.5	5.0	4.5	7.0	4.5	5.0				
Max Green Setting (Gmax), s	31.5	45.0	5.5	17.0	5.5	71.0	5.5	17.0				
Max Q Clear Time (g_c+I1), s	19.5	14.9	5.0	2.3	2.2	23.2	2.4	19.0				
Green Ext Time (p_c), s	1.5	5.6	0.0	0.0	0.0	17.4	0.0	0.0				

Intersection Summary

HCM 6th Ctrl Delay	27.5
HCM 6th LOS	C

Notes

Unsignalized Delay for [EBR, SBR] is excluded from calculations of the approach delay and intersection delay.

HCM 6th Signalized Intersection Summary
 2: Crowfoot Valley Rd/Motsenbocker Rd & Stroh Rd

2025 Background Traffic
 AM Peak Hour



Movement	WBL	WBR	NBT	NBR	SBL	SBT
Lane Configurations						
Traffic Volume (veh/h)	239	214	432	167	144	216
Future Volume (veh/h)	239	214	432	167	144	216
Initial Q (Qb), veh	0	0	0	0	0	0
Ped-Bike Adj(A_pbT)	1.00	1.00		1.00	1.00	
Parking Bus, Adj	1.00	1.00	1.00	1.00	1.00	1.00
Work Zone On Approach	No		No			No
Adj Sat Flow, veh/h/ln	1870	1870	1870	1870	1870	1870
Adj Flow Rate, veh/h	278	249	502	194	167	235
Peak Hour Factor	0.86	0.86	0.86	0.86	0.86	0.92
Percent Heavy Veh, %	2	2	2	2	2	2
Cap, veh/h	348	310	891	755	472	1193
Arrive On Green	0.20	0.20	0.48	0.48	0.08	0.64
Sat Flow, veh/h	1781	1585	1870	1585	1781	1870
Grp Volume(v), veh/h	278	249	502	194	167	235
Grp Sat Flow(s),veh/h/ln	1781	1585	1870	1585	1781	1870
Q Serve(g_s), s	8.9	9.0	11.5	4.4	2.6	3.1
Cycle Q Clear(g_c), s	8.9	9.0	11.5	4.4	2.6	3.1
Prop In Lane	1.00	1.00		1.00	1.00	
Lane Grp Cap(c), veh/h	348	310	891	755	472	1193
V/C Ratio(X)	0.80	0.80	0.56	0.26	0.35	0.20
Avail Cap(c_a), veh/h	445	396	891	755	482	1193
HCM Platoon Ratio	1.00	1.00	1.00	1.00	1.00	1.00
Upstream Filter(I)	1.00	1.00	1.00	1.00	1.00	1.00
Uniform Delay (d), s/veh	23.0	23.0	11.2	9.4	7.6	4.5
Incr Delay (d2), s/veh	7.8	9.1	2.6	0.8	0.4	0.4
Initial Q Delay(d3),s/veh	0.0	0.0	0.0	0.0	0.0	0.0
%ile BackOfQ(50%),veh/ln	4.1	3.8	4.5	1.4	0.7	0.9
Unsig. Movement Delay, s/veh						
LnGrp Delay(d),s/veh	30.8	32.1	13.8	10.2	8.0	4.9
LnGrp LOS	C	C	B	B	A	A
Approach Vol, veh/h	527		696			402
Approach Delay, s/veh	31.4		12.8			6.2
Approach LOS	C		B			A
Timer - Assigned Phs	1	2			6	8
Phs Duration (G+Y+Rc), s	9.7	33.6			43.3	16.7
Change Period (Y+Rc), s	5.0	5.0			5.0	5.0
Max Green Setting (Gmax), s	5.0	25.0			35.0	15.0
Max Q Clear Time (g_c+I1), s	4.6	13.5			5.1	11.0
Green Ext Time (p_c), s	0.0	3.0			1.3	0.7
Intersection Summary						
HCM 6th Ctrl Delay			17.2			
HCM 6th LOS			B			

Intersection						
Int Delay, s/veh	0.6					
Movement	WBL	WBR	NBT	NBR	SBL	SBT
Lane Configurations	↘	↗	↑	↗	↘	↑
Traffic Vol, veh/h	0	145	521	0	60	350
Future Vol, veh/h	0	145	521	0	60	350
Conflicting Peds, #/hr	0	0	0	0	0	0
Sign Control	Stop	Stop	Free	Free	Free	Free
RT Channelized	-	Free	-	None	-	None
Storage Length	300	0	-	0	200	-
Veh in Median Storage, #	0	-	0	-	-	0
Grade, %	0	-	0	-	-	0
Peak Hour Factor	92	92	92	92	92	92
Heavy Vehicles, %	2	2	2	2	2	2
Mvmt Flow	0	158	566	0	65	380

Major/Minor	Minor1	Major1	Major2		
Conflicting Flow All	1076	-	0	0	566
Stage 1	566	-	-	-	-
Stage 2	510	-	-	-	-
Critical Hdwy	6.42	-	-	-	4.12
Critical Hdwy Stg 1	5.42	-	-	-	-
Critical Hdwy Stg 2	5.42	-	-	-	-
Follow-up Hdwy	3.518	-	-	-	2.218
Pot Cap-1 Maneuver	243	0	-	-	1006
Stage 1	568	0	-	-	-
Stage 2	603	0	-	-	-
Platoon blocked, %		-	-	-	-
Mov Cap-1 Maneuver	227	-	-	-	1006
Mov Cap-2 Maneuver	348	-	-	-	-
Stage 1	531	-	-	-	-
Stage 2	603	-	-	-	-

Approach	WB	NB	SB
HCM Control Delay, s	0	0	1.3
HCM LOS	A		

Minor Lane/Major Mvmt	NBT	NBRWBLn1	WBLn2	SBL	SBT
Capacity (veh/h)	-	-	-	1006	-
HCM Lane V/C Ratio	-	-	-	0.065	-
HCM Control Delay (s)	-	-	0	0	8.8
HCM Lane LOS	-	-	A	A	A
HCM 95th %tile Q(veh)	-	-	-	0.2	-

Intersection						
Int Delay, s/veh	0.2					
Movement	WBL	WBR	NBT	NBR	SBL	SBT
Lane Configurations	↘	↗	↑	↗	↘	↑
Traffic Vol, veh/h	8	16	505	7	9	341
Future Vol, veh/h	8	16	505	7	9	341
Conflicting Peds, #/hr	0	0	0	0	0	0
Sign Control	Stop	Stop	Free	Free	Free	Free
RT Channelized	-	Free	-	None	-	None
Storage Length	200	0	-	200	200	-
Veh in Median Storage, #	0	-	0	-	-	0
Grade, %	0	-	0	-	-	0
Peak Hour Factor	92	92	92	92	92	92
Heavy Vehicles, %	2	2	2	2	2	2
Mvmt Flow	9	17	549	8	10	371

Major/Minor	Minor1	Major1	Major2		
Conflicting Flow All	940	-	0	0	557
Stage 1	549	-	-	-	-
Stage 2	391	-	-	-	-
Critical Hdwy	6.42	-	-	-	4.12
Critical Hdwy Stg 1	5.42	-	-	-	-
Critical Hdwy Stg 2	5.42	-	-	-	-
Follow-up Hdwy	3.518	-	-	-	2.218
Pot Cap-1 Maneuver	293	0	-	-	1014
Stage 1	579	0	-	-	-
Stage 2	683	0	-	-	-
Platoon blocked, %		-	-	-	-
Mov Cap-1 Maneuver	290	-	-	-	1014
Mov Cap-2 Maneuver	290	-	-	-	-
Stage 1	573	-	-	-	-
Stage 2	683	-	-	-	-

Approach	WB	NB	SB
HCM Control Delay, s	17.8	0	0.2
HCM LOS	C		

Minor Lane/Major Mvmt	NBT	NBRWBLn1	WBLn2	SBL	SBT
Capacity (veh/h)	-	-	290	-	1014
HCM Lane V/C Ratio	-	-	0.03	-	0.01
HCM Control Delay (s)	-	-	17.8	0	8.6
HCM Lane LOS	-	-	C	A	A
HCM 95th %tile Q(veh)	-	-	0.1	-	0

Intersection						
Int Delay, s/veh	4.1					
Movement	WBL	WBR	NBT	NBR	SBL	SBT
Lane Configurations	↘	↗	↑	↗	↘	↑
Traffic Vol, veh/h	151	110	402	61	19	330
Future Vol, veh/h	151	110	402	61	19	330
Conflicting Peds, #/hr	0	0	0	0	0	0
Sign Control	Stop	Stop	Free	Free	Free	Free
RT Channelized	-	None	-	None	-	None
Storage Length	230	0	-	350	350	-
Veh in Median Storage, #	0	-	0	-	-	0
Grade, %	0	-	0	-	-	0
Peak Hour Factor	88	88	88	88	88	88
Heavy Vehicles, %	2	2	2	2	2	2
Mvmt Flow	172	125	457	69	22	375

Major/Minor	Minor1	Major1	Major2			
Conflicting Flow All	876	457	0	0	526	0
Stage 1	457	-	-	-	-	-
Stage 2	419	-	-	-	-	-
Critical Hdwy	6.42	6.22	-	-	4.12	-
Critical Hdwy Stg 1	5.42	-	-	-	-	-
Critical Hdwy Stg 2	5.42	-	-	-	-	-
Follow-up Hdwy	3.518	3.318	-	-	2.218	-
Pot Cap-1 Maneuver	319	604	-	-	1041	-
Stage 1	638	-	-	-	-	-
Stage 2	664	-	-	-	-	-
Platoon blocked, %			-	-		
Mov Cap-1 Maneuver	312	604	-	-	1041	-
Mov Cap-2 Maneuver	431	-	-	-	-	-
Stage 1	625	-	-	-	-	-
Stage 2	664	-	-	-	-	-

Approach	WB	NB	SB
HCM Control Delay, s	16.1	0	0.5
HCM LOS	C		

Minor Lane/Major Mvmt	NBT	NBRWBLn1	WBLn2	SBL	SBT
Capacity (veh/h)	-	-	431	604	1041
HCM Lane V/C Ratio	-	-	0.398	0.207	0.021
HCM Control Delay (s)	-	-	18.8	12.5	8.5
HCM Lane LOS	-	-	C	B	A
HCM 95th %tile Q(veh)	-	-	1.9	0.8	0.1

HCM 6th Signalized Intersection Summary
7: Parker Rd & Pinery Pkwy

2025 Background Traffic
AM Peak Hour

Movement	EBL	EBT	EBR	WBL	WBT	WBR	NBL	NBT	NBR	SBL	SBT	SBR
Lane Configurations												
Traffic Volume (veh/h)	36	19	12	72	49	377	8	2141	66	92	828	21
Future Volume (veh/h)	36	19	12	72	49	377	8	2141	66	92	828	21
Initial Q (Qb), veh	0	0	0	0	0	0	0	0	0	0	0	0
Ped-Bike Adj(A_pbT)	1.00		1.00	1.00		1.00	1.00		1.00	1.00		1.00
Parking Bus, Adj	1.00	1.00	1.00	1.00	1.00	1.00	1.00	1.00	1.00	1.00	1.00	1.00
Work Zone On Approach		No			No			No			No	
Adj Sat Flow, veh/h/ln	1870	1870	1870	1870	1870	1870	1870	1870	1870	1870	1870	1870
Adj Flow Rate, veh/h	38	20	0	76	52	397	8	2254	69	97	872	0
Peak Hour Factor	0.95	0.95	0.95	0.95	0.95	0.95	0.95	0.95	0.95	0.95	0.95	0.95
Percent Heavy Veh, %	2	2	2	2	2	2	2	2	2	2	2	2
Cap, veh/h	132	383		430	40	309	32	2770	85	176	2946	
Arrive On Green	0.04	0.20	0.00	0.05	0.22	0.22	0.02	0.54	0.54	0.05	0.58	0.00
Sat Flow, veh/h	3456	1870	1585	1781	187	1427	1781	5091	155	3456	5106	1585
Grp Volume(v), veh/h	38	20	0	76	0	449	8	1504	819	97	872	0
Grp Sat Flow(s),veh/h/ln	1728	1870	1585	1781	0	1614	1781	1702	1842	1728	1702	1585
Q Serve(g_s), s	1.3	1.0	0.0	4.0	0.0	26.0	0.5	43.3	43.8	3.3	10.5	0.0
Cycle Q Clear(g_c), s	1.3	1.0	0.0	4.0	0.0	26.0	0.5	43.3	43.8	3.3	10.5	0.0
Prop In Lane	1.00		1.00	1.00		0.88	1.00		0.08	1.00		1.00
Lane Grp Cap(c), veh/h	132	383		430	0	350	32	1852	1003	176	2946	
V/C Ratio(X)	0.29	0.05		0.18	0.00	1.28	0.25	0.81	0.82	0.55	0.30	
Avail Cap(c_a), veh/h	317	405		504	0	350	119	1852	1003	230	2946	
HCM Platoon Ratio	1.00	1.00	1.00	1.00	1.00	1.00	1.00	1.00	1.00	1.00	1.00	1.00
Upstream Filter(I)	1.00	1.00	0.00	1.00	0.00	1.00	1.00	1.00	1.00	0.97	0.97	0.00
Uniform Delay (d), s/veh	56.1	38.4	0.0	34.4	0.0	47.0	58.1	22.3	22.5	55.6	12.9	0.0
Incr Delay (d2), s/veh	1.2	0.1	0.0	0.2	0.0	148.0	3.9	4.0	7.3	2.6	0.2	0.0
Initial Q Delay(d3),s/veh	0.0	0.0	0.0	0.0	0.0	0.0	0.0	0.0	0.0	0.0	0.0	0.0
%ile BackOfQ(50%),veh/ln	0.6	0.5	0.0	1.8	0.0	24.8	0.3	16.1	18.6	1.4	3.6	0.0
Unsig. Movement Delay, s/veh												
LnGrp Delay(d),s/veh	57.3	38.4	0.0	34.6	0.0	195.0	62.1	26.4	29.8	58.2	13.2	0.0
LnGrp LOS	E	D		C	A	F	E	C	C	E	B	
Approach Vol, veh/h		58	A		525			2331			969	A
Approach Delay, s/veh		50.8			171.8			27.7			17.7	
Approach LOS		D			F			C			B	
Timer - Assigned Phs	1	2	3	4	5	6	7	8				
Phs Duration (G+Y+Rc), s	10.1	71.3	10.0	28.6	6.2	75.2	8.6	30.0				
Change Period (Y+Rc), s	5.0	7.0	4.5	5.0	5.0	7.0	5.0	5.0				
Max Green Setting (Gmax), s	7.0	56.0	10.5	25.0	7.0	56.0	10.0	25.0				
Max Q Clear Time (g_c+I1), s	5.3	45.8	6.0	3.0	2.5	12.5	3.3	28.0				
Green Ext Time (p_c), s	0.0	8.5	0.1	0.0	0.0	6.0	0.0	0.0				

Intersection Summary

HCM 6th Ctrl Delay	45.0
HCM 6th LOS	D

Notes

Unsignalized Delay for [EBR, SBR] is excluded from calculations of the approach delay and intersection delay.

Intersection												
Int Delay, s/veh	3.7											
Movement	EBL	EBT	EBR	WBL	WBT	WBR	NBL	NBT	NBR	SBL	SBT	SBR
Lane Configurations	↘	↑	↗	↘	↑	↗	↘	↑	↗	↘	↑	↗
Traffic Vol, veh/h	0	16	5	5	24	40	10	105	10	10	50	0
Future Vol, veh/h	0	16	5	5	24	40	10	105	10	10	50	0
Conflicting Peds, #/hr	0	0	0	0	0	0	0	0	0	0	0	0
Sign Control	Stop	Stop	Stop	Stop	Stop	Stop	Free	Free	Free	Free	Free	Free
RT Channelized	-	-	None	-	-	None	-	-	None	-	-	None
Storage Length	150	-	0	150	-	0	150	-	150	150	-	150
Veh in Median Storage, #	-	0	-	-	0	-	-	0	-	-	0	-
Grade, %	-	0	-	-	0	-	-	0	-	-	0	-
Peak Hour Factor	92	92	92	92	92	92	92	92	92	92	92	92
Heavy Vehicles, %	2	2	2	2	2	2	2	2	2	2	2	2
Mvmt Flow	0	17	5	5	26	43	11	114	11	11	54	0

Major/Minor	Minor2		Minor1		Major1		Major2					
Conflicting Flow All	252	223	54	223	212	114	54	0	0	125	0	0
Stage 1	76	76	-	136	136	-	-	-	-	-	-	-
Stage 2	176	147	-	87	76	-	-	-	-	-	-	-
Critical Hdwy	7.12	6.52	6.22	7.12	6.52	6.22	4.12	-	-	4.12	-	-
Critical Hdwy Stg 1	6.12	5.52	-	6.12	5.52	-	-	-	-	-	-	-
Critical Hdwy Stg 2	6.12	5.52	-	6.12	5.52	-	-	-	-	-	-	-
Follow-up Hdwy	3.518	4.018	3.318	3.518	4.018	3.318	2.218	-	-	2.218	-	-
Pot Cap-1 Maneuver	701	676	1013	733	685	939	1551	-	-	1462	-	-
Stage 1	933	832	-	867	784	-	-	-	-	-	-	-
Stage 2	826	775	-	921	832	-	-	-	-	-	-	-
Platoon blocked, %	-	-	-	-	-	-	-	-	-	-	-	-
Mov Cap-1 Maneuver	641	666	1013	707	675	939	1551	-	-	1462	-	-
Mov Cap-2 Maneuver	641	666	-	707	675	-	-	-	-	-	-	-
Stage 1	926	825	-	861	779	-	-	-	-	-	-	-
Stage 2	756	770	-	890	825	-	-	-	-	-	-	-

Approach	EB		WB		NB		SB			
HCM Control Delay, s	10.1		9.6		0.6		1.2			
HCM LOS	B		A							

Minor Lane/Major Mvmt	NBL	NBT	NBR	EBLn1	EBLn2	EBLn3	WBLn1	WBLn2	WBLn3	SBL	SBT	SBR
Capacity (veh/h)	1551	-	-	-	666	1013	707	675	939	1462	-	-
HCM Lane V/C Ratio	0.007	-	-	-	0.026	0.005	0.008	0.039	0.046	0.007	-	-
HCM Control Delay (s)	7.3	-	-	0	10.6	8.6	10.1	10.5	9	7.5	-	-
HCM Lane LOS	A	-	-	A	B	A	B	B	A	A	-	-
HCM 95th %tile Q(veh)	0	-	-	-	0.1	0	0	0.1	0.1	0	-	-

Intersection

Int Delay, s/veh 2.4

Movement	EBT	EBR	WBL	WBT	NBL	NBR
Lane Configurations						
Traffic Vol, veh/h	27	9	6	53	16	12
Future Vol, veh/h	27	9	6	53	16	12
Conflicting Peds, #/hr	0	0	0	0	0	0
Sign Control	Free	Free	Free	Free	Stop	Stop
RT Channelized	-	None	-	None	-	None
Storage Length	-	-	0	-	0	-
Veh in Median Storage, #	0	-	-	0	0	-
Grade, %	0	-	-	0	0	-
Peak Hour Factor	92	92	92	92	92	92
Heavy Vehicles, %	2	2	2	2	2	2
Mvmt Flow	29	10	7	58	17	13

Major/Minor

	Major1	Major2	Minor1		
Conflicting Flow All	0	0	39	0	106
Stage 1	-	-	-	-	34
Stage 2	-	-	-	-	72
Critical Hdwy	-	-	4.12	-	6.42
Critical Hdwy Stg 1	-	-	-	-	5.42
Critical Hdwy Stg 2	-	-	-	-	5.42
Follow-up Hdwy	-	-	2.218	-	3.518
Pot Cap-1 Maneuver	-	-	1571	-	892
Stage 1	-	-	-	-	988
Stage 2	-	-	-	-	951
Platoon blocked, %	-	-	-	-	-
Mov Cap-1 Maneuver	-	-	1571	-	888
Mov Cap-2 Maneuver	-	-	-	-	888
Stage 1	-	-	-	-	984
Stage 2	-	-	-	-	951

Approach

	EB	WB	NB
HCM Control Delay, s	0	0.7	8.9
HCM LOS			A

Minor Lane/Major Mvmt

	NBLn1	EBT	EBR	WBL	WBT
Capacity (veh/h)	947	-	-	1571	-
HCM Lane V/C Ratio	0.032	-	-	0.004	-
HCM Control Delay (s)	8.9	-	-	7.3	-
HCM Lane LOS	A	-	-	A	-
HCM 95th %tile Q(veh)	0.1	-	-	0	-

HCM 6th Signalized Intersection Summary
 2: Crowfoot Valley Rd/Motsenbocker Rd & Stroh Rd

2025 Background Traffic
 PM Peak Hour



Movement	WBL	WBR	NBT	NBR	SBL	SBT
Lane Configurations						
Traffic Volume (veh/h)	246	145	248	199	350	346
Future Volume (veh/h)	246	145	248	199	350	346
Initial Q (Qb), veh	0	0	0	0	0	0
Ped-Bike Adj(A_pbT)	1.00	1.00		1.00	1.00	
Parking Bus, Adj	1.00	1.00	1.00	1.00	1.00	1.00
Work Zone On Approach	No		No			No
Adj Sat Flow, veh/h/ln	1870	1870	1870	1870	1870	1870
Adj Flow Rate, veh/h	267	158	270	216	380	376
Peak Hour Factor	0.92	0.92	0.92	0.92	0.92	0.92
Percent Heavy Veh, %	2	2	2	2	2	2
Cap, veh/h	332	295	898	761	626	1210
Arrive On Green	0.19	0.19	0.48	0.48	0.08	0.65
Sat Flow, veh/h	1781	1585	1870	1585	1781	1870
Grp Volume(v), veh/h	267	158	270	216	380	376
Grp Sat Flow(s),veh/h/ln	1781	1585	1870	1585	1781	1870
Q Serve(g_s), s	8.6	5.4	5.3	4.9	5.0	5.3
Cycle Q Clear(g_c), s	8.6	5.4	5.3	4.9	5.0	5.3
Prop In Lane	1.00	1.00		1.00	1.00	
Lane Grp Cap(c), veh/h	332	295	898	761	626	1210
V/C Ratio(X)	0.80	0.53	0.30	0.28	0.61	0.31
Avail Cap(c_a), veh/h	445	396	898	761	626	1210
HCM Platoon Ratio	1.00	1.00	1.00	1.00	1.00	1.00
Upstream Filter(I)	1.00	1.00	1.00	1.00	1.00	1.00
Uniform Delay (d), s/veh	23.4	22.1	9.5	9.4	8.3	4.7
Incr Delay (d2), s/veh	7.6	1.5	0.9	0.9	1.7	0.7
Initial Q Delay(d3),s/veh	0.0	0.0	0.0	0.0	0.0	0.0
%ile BackOfQ(50%),veh/ln	3.9	1.9	2.0	1.6	2.0	1.5
Unsig. Movement Delay, s/veh						
LnGrp Delay(d),s/veh	31.0	23.6	10.3	10.3	10.0	5.3
LnGrp LOS	C	C	B	B	A	A
Approach Vol, veh/h	425		486			756
Approach Delay, s/veh	28.2		10.3			7.7
Approach LOS	C		B			A
Timer - Assigned Phs	1	2			6	8
Phs Duration (G+Y+Rc), s	10.0	33.8			43.8	16.2
Change Period (Y+Rc), s	5.0	5.0			5.0	5.0
Max Green Setting (Gmax), s	5.0	25.0			35.0	15.0
Max Q Clear Time (g_c+I1), s	7.0	7.3			7.3	10.6
Green Ext Time (p_c), s	0.0	2.1			2.3	0.6

Intersection Summary

HCM 6th Ctrl Delay			13.7			
HCM 6th LOS			B			

Intersection						
Int Delay, s/veh	1.4					
Movement	WBL	WBR	NBT	NBR	SBL	SBT
Lane Configurations	↘	↗	↑	↗	↘	↑
Traffic Vol, veh/h	0	82	367	0	146	402
Future Vol, veh/h	0	82	367	0	146	402
Conflicting Peds, #/hr	0	0	0	0	0	0
Sign Control	Stop	Stop	Free	Free	Free	Free
RT Channelized	-	Free	-	None	-	None
Storage Length	300	0	-	0	200	-
Veh in Median Storage, #	0	-	0	-	-	0
Grade, %	0	-	0	-	-	0
Peak Hour Factor	92	92	92	92	92	92
Heavy Vehicles, %	2	2	2	2	2	2
Mvmt Flow	0	89	399	0	159	437

Major/Minor	Minor1	Major1	Major2		
Conflicting Flow All	1154	-	0	0	399
Stage 1	399	-	-	-	-
Stage 2	755	-	-	-	-
Critical Hdwy	6.42	-	-	-	4.12
Critical Hdwy Stg 1	5.42	-	-	-	-
Critical Hdwy Stg 2	5.42	-	-	-	-
Follow-up Hdwy	3.518	-	-	-	2.218
Pot Cap-1 Maneuver	218	0	-	-	1160
Stage 1	678	0	-	-	-
Stage 2	464	0	-	-	-
Platoon blocked, %					
Mov Cap-1 Maneuver	188	-	-	-	1160
Mov Cap-2 Maneuver	254	-	-	-	-
Stage 1	585	-	-	-	-
Stage 2	464	-	-	-	-

Approach	WB	NB	SB
HCM Control Delay, s	0	0	2.3
HCM LOS	A		

Minor Lane/Major Mvmt	NBT	NBRWBLn1WBLn2	SBL	SBT
Capacity (veh/h)	-	-	-	1160
HCM Lane V/C Ratio	-	-	-	0.137
HCM Control Delay (s)	-	-	0	0
HCM Lane LOS	-	-	A	A
HCM 95th %tile Q(veh)	-	-	-	0.5

Intersection						
Int Delay, s/veh	0.3					
Movement	WBL	WBR	NBT	NBR	SBL	SBT
Lane Configurations	↘	↗	↑	↗	↘	↑
Traffic Vol, veh/h	5	10	357	3	16	386
Future Vol, veh/h	5	10	357	3	16	386
Conflicting Peds, #/hr	0	0	0	0	0	0
Sign Control	Stop	Stop	Free	Free	Free	Free
RT Channelized	-	Free	-	None	-	None
Storage Length	200	0	-	200	200	-
Veh in Median Storage, #	0	-	0	-	-	0
Grade, %	0	-	0	-	-	0
Peak Hour Factor	92	92	92	92	92	92
Heavy Vehicles, %	2	2	2	2	2	2
Mvmt Flow	5	11	388	3	17	420

Major/Minor	Minor1	Major1	Major2		
Conflicting Flow All	842	-	0	0	391
Stage 1	388	-	-	-	-
Stage 2	454	-	-	-	-
Critical Hdwy	6.42	-	-	-	4.12
Critical Hdwy Stg 1	5.42	-	-	-	-
Critical Hdwy Stg 2	5.42	-	-	-	-
Follow-up Hdwy	3.518	-	-	-	2.218
Pot Cap-1 Maneuver	334	0	-	-	1168
Stage 1	686	0	-	-	-
Stage 2	640	0	-	-	-
Platoon blocked, %		-	-	-	-
Mov Cap-1 Maneuver	329	-	-	-	1168
Mov Cap-2 Maneuver	329	-	-	-	-
Stage 1	676	-	-	-	-
Stage 2	640	-	-	-	-

Approach	WB	NB	SB
HCM Control Delay, s	16.1	0	0.3
HCM LOS	C		

Minor Lane/Major Mvmt	NBT	NBRWBLn1WBLn2	SBL	SBT
Capacity (veh/h)	-	-	329	-
HCM Lane V/C Ratio	-	-	0.017	-
HCM Control Delay (s)	-	-	16.1	0
HCM Lane LOS	-	-	C	A
HCM 95th %tile Q(veh)	-	-	0.1	-

Intersection						
Int Delay, s/veh	2.6					
Movement	WBL	WBR	NBT	NBR	SBL	SBT
Lane Configurations	↘	↗	↑	↗	↘	↑
Traffic Vol, veh/h	94	39	321	139	62	329
Future Vol, veh/h	94	39	321	139	62	329
Conflicting Peds, #/hr	0	0	0	0	0	0
Sign Control	Stop	Stop	Free	Free	Free	Free
RT Channelized	-	None	-	None	-	None
Storage Length	230	0	-	350	350	-
Veh in Median Storage, #	0	-	0	-	-	0
Grade, %	0	-	0	-	-	0
Peak Hour Factor	90	90	90	90	90	90
Heavy Vehicles, %	2	2	2	2	2	2
Mvmt Flow	104	43	357	154	69	366

Major/Minor	Minor1	Major1	Major2		
Conflicting Flow All	861	357	0	0	511
Stage 1	357	-	-	-	-
Stage 2	504	-	-	-	-
Critical Hdwy	6.42	6.22	-	-	4.12
Critical Hdwy Stg 1	5.42	-	-	-	-
Critical Hdwy Stg 2	5.42	-	-	-	-
Follow-up Hdwy	3.518	3.318	-	-	2.218
Pot Cap-1 Maneuver	326	687	-	-	1054
Stage 1	708	-	-	-	-
Stage 2	607	-	-	-	-
Platoon blocked, %					
Mov Cap-1 Maneuver	305	687	-	-	1054
Mov Cap-2 Maneuver	407	-	-	-	-
Stage 1	662	-	-	-	-
Stage 2	607	-	-	-	-

Approach	WB	NB	SB
HCM Control Delay, s	15.1	0	1.4
HCM LOS	C		

Minor Lane/Major Mvmt	NBT	NBRWBLn1	WBLn2	SBL	SBT
Capacity (veh/h)	-	-	407	687	1054
HCM Lane V/C Ratio	-	-	0.257	0.063	0.065
HCM Control Delay (s)	-	-	16.9	10.6	8.7
HCM Lane LOS	-	-	C	B	A
HCM 95th %tile Q(veh)	-	-	1	0.2	0.2

HCM 6th Signalized Intersection Summary
7: Parker Rd & Pinery Pkwy

2025 Background Traffic
PM Peak Hour



Movement	EBL	EBT	EBR	WBL	WBT	WBR	NBL	NBT	NBR	SBL	SBT	SBR
Lane Configurations	↖↗	↑	↖	↖	↖		↖	↑↑↑		↖↗	↑↑↑	↖
Traffic Volume (veh/h)	29	57	6	46	30	206	3	1143	32	458	1976	49
Future Volume (veh/h)	29	57	6	46	30	206	3	1143	32	458	1976	49
Initial Q (Qb), veh	0	0	0	0	0	0	0	0	0	0	0	0
Ped-Bike Adj(A_pbT)	1.00		1.00	1.00		1.00	1.00		1.00	1.00		1.00
Parking Bus, Adj	1.00	1.00	1.00	1.00	1.00	1.00	1.00	1.00	1.00	1.00	1.00	1.00
Work Zone On Approach		No			No			No			No	
Adj Sat Flow, veh/h/ln	1870	1870	1870	1870	1870	1870	1870	1870	1870	1870	1870	1870
Adj Flow Rate, veh/h	31	61	0	49	32	219	3	1216	34	487	2102	0
Peak Hour Factor	0.94	0.94	0.94	0.94	0.94	0.94	0.94	0.94	0.94	0.94	0.94	0.94
Percent Heavy Veh, %	2	2	2	2	2	2	2	2	2	2	2	2
Cap, veh/h	93	221		239	26	176	7	2593	73	571	3417	
Arrive On Green	0.03	0.12	0.00	0.03	0.13	0.13	0.00	0.51	0.51	0.17	0.67	0.00
Sat Flow, veh/h	3456	1870	1585	1781	206	1410	1781	5106	143	3456	5106	1585
Grp Volume(v), veh/h	31	61	0	49	0	251	3	811	439	487	2102	0
Grp Sat Flow(s),veh/h/ln	1728	1870	1585	1781	0	1616	1781	1702	1845	1728	1702	1585
Q Serve(g_s), s	1.1	3.6	0.0	2.9	0.0	15.0	0.2	18.5	18.5	16.4	27.8	0.0
Cycle Q Clear(g_c), s	1.1	3.6	0.0	2.9	0.0	15.0	0.2	18.5	18.5	16.4	27.8	0.0
Prop In Lane	1.00		1.00	1.00		0.87	1.00		0.08	1.00		1.00
Lane Grp Cap(c), veh/h	93	221		239	0	202	7	1729	937	571	3417	
V/C Ratio(X)	0.33	0.28		0.21	0.00	1.24	0.42	0.47	0.47	0.85	0.62	
Avail Cap(c_a), veh/h	158	234		260	0	202	111	1729	937	907	3417	
HCM Platoon Ratio	1.00	1.00	1.00	1.00	1.00	1.00	1.00	1.00	1.00	1.00	1.00	1.00
Upstream Filter(I)	1.00	1.00	0.00	1.00	0.00	1.00	1.00	1.00	1.00	0.54	0.54	0.00
Uniform Delay (d), s/veh	57.3	48.2	0.0	44.4	0.0	52.5	59.6	19.1	19.1	48.7	11.2	0.0
Incr Delay (d2), s/veh	2.1	0.7	0.0	0.4	0.0	143.7	35.7	0.9	1.7	2.6	0.5	0.0
Initial Q Delay(d3),s/veh	0.0	0.0	0.0	0.0	0.0	0.0	0.0	0.0	0.0	0.0	0.0	0.0
%ile BackOfQ(50%),veh/ln	0.5	1.7	0.0	1.3	0.0	14.2	0.2	6.8	7.6	7.0	8.5	0.0
Unsig. Movement Delay, s/veh												
LnGrp Delay(d),s/veh	59.4	48.9	0.0	44.9	0.0	196.2	95.4	20.0	20.8	51.3	11.6	0.0
LnGrp LOS	E	D		D	A	F	F	B	C	D	B	
Approach Vol, veh/h		92	A		300			1253			2589	A
Approach Delay, s/veh		52.4			171.4			20.4			19.1	
Approach LOS		D			F			C			B	
Timer - Assigned Phs	1	2	3	4	5	6	7	8				
Phs Duration (G+Y+Rc), s	24.3	68.0	8.5	19.2	5.0	87.3	7.7	20.0				
Change Period (Y+Rc), s	4.5	7.0	4.5	5.0	4.5	7.0	4.5	5.0				
Max Green Setting (Gmax), s	31.5	47.0	5.5	15.0	7.5	71.0	5.5	15.0				
Max Q Clear Time (g_c+I1), s	18.4	20.5	4.9	5.6	2.2	29.8	3.1	17.0				
Green Ext Time (p_c), s	1.4	8.1	0.0	0.1	0.0	21.9	0.0	0.0				

Intersection Summary

HCM 6th Ctrl Delay	31.0
HCM 6th LOS	C

Notes

Unsignalized Delay for [EBR, SBR] is excluded from calculations of the approach delay and intersection delay.

Intersection												
Int Delay, s/veh	3.8											
Movement	EBL	EBT	EBR	WBL	WBT	WBR	NBL	NBT	NBR	SBL	SBT	SBR
Lane Configurations	↙	↑	↗	↙	↑	↗	↙	↑	↗	↙	↑	↗
Traffic Vol, veh/h	0	19	10	5	15	22	5	60	10	49	97	0
Future Vol, veh/h	0	19	10	5	15	22	5	60	10	49	97	0
Conflicting Peds, #/hr	0	0	0	0	0	0	0	0	0	0	0	0
Sign Control	Stop	Stop	Stop	Stop	Stop	Stop	Free	Free	Free	Free	Free	Free
RT Channelized	-	-	None	-	-	None	-	-	None	-	-	None
Storage Length	150	-	0	150	-	0	150	-	150	150	-	150
Veh in Median Storage, #	-	0	-	-	0	-	-	0	-	-	0	-
Grade, %	-	0	-	-	0	-	-	0	-	-	0	-
Peak Hour Factor	92	92	92	92	92	92	92	92	92	92	92	92
Heavy Vehicles, %	2	2	2	2	2	2	2	2	2	2	2	2
Mvmt Flow	0	21	11	5	16	24	5	65	11	53	105	0

Major/Minor	Minor2		Minor1			Major1		Major2				
Conflicting Flow All	312	297	105	302	286	65	105	0	0	76	0	0
Stage 1	211	211	-	75	75	-	-	-	-	-	-	-
Stage 2	101	86	-	227	211	-	-	-	-	-	-	-
Critical Hdwy	7.12	6.52	6.22	7.12	6.52	6.22	4.12	-	-	4.12	-	-
Critical Hdwy Stg 1	6.12	5.52	-	6.12	5.52	-	-	-	-	-	-	-
Critical Hdwy Stg 2	6.12	5.52	-	6.12	5.52	-	-	-	-	-	-	-
Follow-up Hdwy	3.518	4.018	3.318	3.518	4.018	3.318	2.218	-	-	2.218	-	-
Pot Cap-1 Maneuver	641	615	949	650	623	999	1486	-	-	1523	-	-
Stage 1	791	728	-	934	833	-	-	-	-	-	-	-
Stage 2	905	824	-	776	728	-	-	-	-	-	-	-
Platoon blocked, %	-	-	-	-	-	-	-	-	-	-	-	-
Mov Cap-1 Maneuver	595	592	949	607	599	999	1486	-	-	1523	-	-
Mov Cap-2 Maneuver	595	592	-	607	599	-	-	-	-	-	-	-
Stage 1	789	703	-	931	831	-	-	-	-	-	-	-
Stage 2	863	822	-	719	703	-	-	-	-	-	-	-

Approach	EB		WB		NB		SB	
HCM Control Delay, s	10.4		9.9		0.5		2.5	
HCM LOS	B		A					

Minor Lane/Major Mvmt	NBL	NBT	NBR	EBLn1	EBLn2	EBLn3	WBLn1	WBLn2	WBLn3	SBL	SBT	SBR
Capacity (veh/h)	1486	-	-	-	592	949	607	599	999	1523	-	-
HCM Lane V/C Ratio	0.004	-	-	-	0.035	0.011	0.009	0.027	0.024	0.035	-	-
HCM Control Delay (s)	7.4	-	-	0	11.3	8.8	11	11.2	8.7	7.4	-	-
HCM Lane LOS	A	-	-	A	B	A	B	B	A	A	-	-
HCM 95th %tile Q(veh)	0	-	-	-	0.1	0	0	0.1	0.1	0.1	-	-

Intersection

Int Delay, s/veh 1.7

Movement	EBT	EBR	WBL	WBT	NBL	NBR
Lane Configurations	↔		↔	↔	↔	↔
Traffic Vol, veh/h	62	16	11	32	10	7
Future Vol, veh/h	62	16	11	32	10	7
Conflicting Peds, #/hr	0	0	0	0	0	0
Sign Control	Free	Free	Free	Free	Stop	Stop
RT Channelized	-	None	-	None	-	None
Storage Length	-	-	0	-	0	-
Veh in Median Storage, #	0	-	-	0	0	-
Grade, %	0	-	-	0	0	-
Peak Hour Factor	92	92	92	92	92	92
Heavy Vehicles, %	2	2	2	2	2	2
Mvmt Flow	67	17	12	35	11	8

Major/Minor	Major1	Major2	Minor1		
Conflicting Flow All	0	0	84	0	135 76
Stage 1	-	-	-	-	76 -
Stage 2	-	-	-	-	59 -
Critical Hdwy	-	-	4.12	-	6.42 6.22
Critical Hdwy Stg 1	-	-	-	-	5.42 -
Critical Hdwy Stg 2	-	-	-	-	5.42 -
Follow-up Hdwy	-	-	2.218	-	3.518 3.318
Pot Cap-1 Maneuver	-	-	1513	-	859 985
Stage 1	-	-	-	-	947 -
Stage 2	-	-	-	-	964 -
Platoon blocked, %	-	-	-	-	-
Mov Cap-1 Maneuver	-	-	1513	-	852 985
Mov Cap-2 Maneuver	-	-	-	-	852 -
Stage 1	-	-	-	-	939 -
Stage 2	-	-	-	-	964 -

Approach	EB	WB	NB
HCM Control Delay, s	0	1.9	9.1
HCM LOS			A

Minor Lane/Major Mvmt	NBLn1	EBT	EBR	WBL	WBT
Capacity (veh/h)	902	-	-	1513	-
HCM Lane V/C Ratio	0.02	-	-	0.008	-
HCM Control Delay (s)	9.1	-	-	7.4	-
HCM Lane LOS	A	-	-	A	-
HCM 95th %tile Q(veh)	0.1	-	-	0	-

HCM 6th Signalized Intersection Summary
 2: Crowfoot Valley Rd/Motsenbocker Rd & Stroh Rd

2025 Total
 AM Peak



Movement	WBL	WBR	NBT	NBR	SBL	SBT
Lane Configurations						
Traffic Volume (veh/h)	239	214	728	167	144	324
Future Volume (veh/h)	239	214	728	167	144	324
Initial Q (Qb), veh	0	0	0	0	0	0
Ped-Bike Adj(A_pbT)	1.00	1.00		1.00	1.00	
Parking Bus, Adj	1.00	1.00	1.00	1.00	1.00	1.00
Work Zone On Approach	No		No			No
Adj Sat Flow, veh/h/ln	1870	1870	1870	1870	1870	1870
Adj Flow Rate, veh/h	278	249	847	194	167	352
Peak Hour Factor	0.86	0.86	0.86	0.86	0.86	0.92
Percent Heavy Veh, %	2	2	2	2	2	2
Cap, veh/h	348	310	891	755	283	1193
Arrive On Green	0.20	0.20	0.48	0.48	0.08	0.64
Sat Flow, veh/h	1781	1585	1870	1585	1781	1870
Grp Volume(v), veh/h	278	249	847	194	167	352
Grp Sat Flow(s),veh/h/ln	1781	1585	1870	1585	1781	1870
Q Serve(g_s), s	8.9	9.0	26.0	4.4	2.6	5.0
Cycle Q Clear(g_c), s	8.9	9.0	26.0	4.4	2.6	5.0
Prop In Lane	1.00	1.00		1.00	1.00	
Lane Grp Cap(c), veh/h	348	310	891	755	283	1193
V/C Ratio(X)	0.80	0.80	0.95	0.26	0.59	0.29
Avail Cap(c_a), veh/h	445	396	891	755	292	1193
HCM Platoon Ratio	1.00	1.00	1.00	1.00	1.00	1.00
Upstream Filter(I)	1.00	1.00	1.00	1.00	1.00	1.00
Uniform Delay (d), s/veh	23.0	23.0	15.0	9.4	13.2	4.8
Incr Delay (d2), s/veh	7.8	9.1	20.3	0.8	3.0	0.6
Initial Q Delay(d3),s/veh	0.0	0.0	0.0	0.0	0.0	0.0
%ile BackOfQ(50%),veh/ln	4.1	3.8	13.7	1.4	1.1	1.5
Unsig. Movement Delay, s/veh						
LnGrp Delay(d),s/veh	30.8	32.1	35.3	10.2	16.2	5.5
LnGrp LOS	C	C	D	B	B	A
Approach Vol, veh/h	527		1041			519
Approach Delay, s/veh	31.4		30.6			8.9
Approach LOS	C		C			A
Timer - Assigned Phs	1	2			6	8
Phs Duration (G+Y+Rc), s	9.7	33.6			43.3	16.7
Change Period (Y+Rc), s	5.0	5.0			5.0	5.0
Max Green Setting (Gmax), s	5.0	25.0			35.0	15.0
Max Q Clear Time (g_c+I1), s	4.6	28.0			7.0	11.0
Green Ext Time (p_c), s	0.0	0.0			2.1	0.7

Intersection Summary

HCM 6th Ctrl Delay			25.4			
HCM 6th LOS			C			

HCM Unsignalized Intersection Capacity Analysis

3: Crowfoot Valley Rd & Bayou Gulch Rd

2025 Total
AM Peak



Movement	WBL	WBR	NBT	NBR	SBL	SBT
Lane Configurations						
Traffic Volume (veh/h)	6	282	682	3	127	391
Future Volume (Veh/h)	6	282	682	3	127	391
Sign Control	Stop		Free		Free	
Grade	0%		0%		0%	
Peak Hour Factor	0.92	0.92	0.92	0.92	0.92	0.92
Hourly flow rate (vph)	7	307	741	3	138	425
Pedestrians						
Lane Width (ft)						
Walking Speed (ft/s)						
Percent Blockage						
Right turn flare (veh)						
Median type	TWLTL			None		
Median storage (veh)	2					
Upstream signal (ft)						
pX, platoon unblocked						
vC, conflicting volume	1442	741			744	
vC1, stage 1 conf vol	741					
vC2, stage 2 conf vol	701					
vCu, unblocked vol	1442	741			744	
tC, single (s)	6.4	6.2			4.1	
tC, 2 stage (s)	5.4					
tF (s)	3.5	3.3			2.2	
p0 queue free %	98	26			84	
cM capacity (veh/h)	325	416			864	
Direction, Lane #	WB 1	WB 2	NB 1	NB 2	SB 1	SB 2
Volume Total	7	307	741	3	138	425
Volume Left	7	0	0	0	138	0
Volume Right	0	307	0	3	0	0
cSH	325	416	1700	1700	864	1700
Volume to Capacity	0.02	0.74	0.44	0.00	0.16	0.25
Queue Length 95th (ft)	2	147	0	0	14	0
Control Delay (s)	16.3	34.3	0.0	0.0	10.0	0.0
Lane LOS	C	D			A	
Approach Delay (s)	33.9		0.0		2.4	
Approach LOS	D					
Intersection Summary						
Average Delay			7.4			
Intersection Capacity Utilization			60.0%	ICU Level of Service	B	
Analysis Period (min)			15			

HCM 6th TWSC
4: Crowfoot Valley Rd & Pinery Pkwy

2025 Total
AM Peak

Intersection

Int Delay, s/veh 2.5

Movement	WBL	WBR	NBT	NBR	SBL	SBT
Lane Configurations	↘	↗	↑	↗	↘	↑
Traffic Vol, veh/h	75	177	508	32	50	347
Future Vol, veh/h	75	177	508	32	50	347
Conflicting Peds, #/hr	0	0	0	0	0	0
Sign Control	Stop	Stop	Free	Free	Free	Free
RT Channelized	-	Free	-	None	-	None
Storage Length	200	0	-	200	200	-
Veh in Median Storage, #	0	-	0	-	-	0
Grade, %	0	-	0	-	-	0
Peak Hour Factor	92	92	92	92	92	92
Heavy Vehicles, %	2	2	2	2	2	2
Mvmt Flow	82	192	552	35	54	377

Major/Minor

	Minor1	Major1	Major2		
Conflicting Flow All	1037	-	0	0	587
Stage 1	552	-	-	-	-
Stage 2	485	-	-	-	-
Critical Hdwy	6.42	-	-	-	4.12
Critical Hdwy Stg 1	5.42	-	-	-	-
Critical Hdwy Stg 2	5.42	-	-	-	-
Follow-up Hdwy	3.518	-	-	-	2.218
Pot Cap-1 Maneuver	256	0	-	-	988
Stage 1	577	0	-	-	-
Stage 2	619	0	-	-	-
Platoon blocked, %		-	-	-	-
Mov Cap-1 Maneuver	242	-	-	-	988
Mov Cap-2 Maneuver	242	-	-	-	-
Stage 1	545	-	-	-	-
Stage 2	619	-	-	-	-

Approach

	WB	NB	SB
HCM Control Delay, s	27.3	0	1.1
HCM LOS	D		

Minor Lane/Major Mvmt

	NBT	NBRWBLn1	WBLn2	SBL	SBT
Capacity (veh/h)	-	-	242	-	988
HCM Lane V/C Ratio	-	-	0.337	-	0.055
HCM Control Delay (s)	-	-	27.3	0	8.9
HCM Lane LOS	-	-	D	A	A
HCM 95th %tile Q(veh)	-	-	1.4	-	0.2

HCM 6th TWSC
5: Crowfoot Valley Rd & Pradera Pkwy

2025 Total
AM Peak

Intersection						
Int Delay, s/veh	4.1					
Movement	WBL	WBR	NBT	NBR	SBL	SBT
Lane Configurations	↘	↘	↑	↘	↘	↑
Traffic Vol, veh/h	151	110	429	61	19	403
Future Vol, veh/h	151	110	429	61	19	403
Conflicting Peds, #/hr	0	0	0	0	0	0
Sign Control	Stop	Stop	Free	Free	Free	Free
RT Channelized	-	None	-	None	-	None
Storage Length	230	0	-	350	350	-
Veh in Median Storage, #	0	-	0	-	-	0
Grade, %	0	-	0	-	-	0
Peak Hour Factor	88	88	88	88	88	88
Heavy Vehicles, %	2	2	2	2	2	2
Mvmt Flow	172	125	488	69	22	458

Major/Minor	Minor1	Major1	Major2			
Conflicting Flow All	990	488	0	0	557	0
Stage 1	488	-	-	-	-	-
Stage 2	502	-	-	-	-	-
Critical Hdwy	6.42	6.22	-	-	4.12	-
Critical Hdwy Stg 1	5.42	-	-	-	-	-
Critical Hdwy Stg 2	5.42	-	-	-	-	-
Follow-up Hdwy	3.518	3.318	-	-	2.218	-
Pot Cap-1 Maneuver	273	580	-	-	1014	-
Stage 1	617	-	-	-	-	-
Stage 2	608	-	-	-	-	-
Platoon blocked, %			-	-	-	-
Mov Cap-1 Maneuver	267	580	-	-	1014	-
Mov Cap-2 Maneuver	393	-	-	-	-	-
Stage 1	603	-	-	-	-	-
Stage 2	608	-	-	-	-	-

Approach	WB	NB	SB
HCM Control Delay, s	17.6	0	0.4
HCM LOS	C		

Minor Lane/Major Mvmt	NBT	NBR	WBLn1	WBLn2	SBL	SBT
Capacity (veh/h)	-	-	393	580	1014	-
HCM Lane V/C Ratio	-	-	0.437	0.216	0.021	-
HCM Control Delay (s)	-	-	21.1	12.9	8.6	-
HCM Lane LOS	-	-	C	B	A	-
HCM 95th %tile Q(veh)	-	-	2.2	0.8	0.1	-

HCM 6th Signalized Intersection Summary
7: Parker Rd & Pinery Pkwy

2025 Total
AM Peak

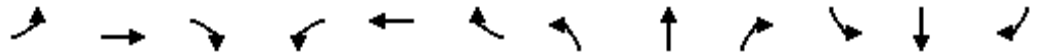

Movement	EBL	EBT	EBR	WBL	WBT	WBR	NBL	NBT	NBR	SBL	SBT	SBR
Lane Configurations	↔↔	↑	↔	↔	↔		↔	↑↑↑		↔↔	↑↑↑	↔
Traffic Volume (veh/h)	137	19	20	72	49	377	12	2141	66	92	828	61
Future Volume (veh/h)	137	19	20	72	49	377	12	2141	66	92	828	61
Initial Q (Qb), veh	0	0	0	0	0	0	0	0	0	0	0	0
Ped-Bike Adj(A_pbT)	1.00		1.00	1.00		1.00	1.00		1.00	1.00		1.00
Parking Bus, Adj	1.00	1.00	1.00	1.00	1.00	1.00	1.00	1.00	1.00	1.00	1.00	1.00
Work Zone On Approach		No			No			No			No	
Adj Sat Flow, veh/h/ln	1870	1870	1870	1870	1870	1870	1870	1870	1870	1870	1870	1870
Adj Flow Rate, veh/h	144	20	0	76	52	397	13	2254	69	97	872	0
Peak Hour Factor	0.95	0.95	0.95	0.95	0.95	0.95	0.95	0.95	0.95	0.95	0.95	0.95
Percent Heavy Veh, %	2	2	2	2	2	2	2	2	2	2	2	2
Cap, veh/h	228	436		458	42	321	41	2629	80	176	2779	
Arrive On Green	0.07	0.23	0.00	0.05	0.22	0.22	0.02	0.52	0.51	0.05	0.54	0.00
Sat Flow, veh/h	3456	1870	1585	1781	187	1427	1781	5091	155	3456	5106	1585
Grp Volume(v), veh/h	144	20	0	76	0	449	13	1504	819	97	872	0
Grp Sat Flow(s),veh/h/ln	1728	1870	1585	1781	0	1614	1781	1702	1842	1728	1702	1585
Q Serve(g_s), s	4.9	1.0	0.0	3.9	0.0	27.0	0.9	46.0	46.4	3.3	11.3	0.0
Cycle Q Clear(g_c), s	4.9	1.0	0.0	3.9	0.0	27.0	0.9	46.0	46.4	3.3	11.3	0.0
Prop In Lane	1.00		1.00	1.00		0.88	1.00		0.08	1.00		1.00
Lane Grp Cap(c), veh/h	228	436		458	0	363	41	1758	951	176	2779	
V/C Ratio(X)	0.63	0.05		0.17	0.00	1.24	0.32	0.86	0.86	0.55	0.31	
Avail Cap(c_a), veh/h	317	436		532	0	363	119	1758	951	230	2779	
HCM Platoon Ratio	1.00	1.00	1.00	1.00	1.00	1.00	1.00	1.00	1.00	1.00	1.00	1.00
Upstream Filter(I)	1.00	1.00	0.00	1.00	0.00	1.00	1.00	1.00	1.00	0.96	0.96	0.00
Uniform Delay (d), s/veh	54.6	35.7	0.0	33.3	0.0	46.9	57.7	25.2	25.3	55.6	15.0	0.0
Incr Delay (d2), s/veh	2.9	0.0	0.0	0.2	0.0	128.1	4.4	5.6	10.1	2.6	0.3	0.0
Initial Q Delay(d3),s/veh	0.0	0.0	0.0	0.0	0.0	0.0	0.0	0.0	0.0	0.0	0.0	0.0
%ile BackOfQ(50%),veh/ln	2.2	0.5	0.0	1.7	0.0	23.8	0.4	17.7	20.5	1.4	4.0	0.0
Unsig. Movement Delay, s/veh												
LnGrp Delay(d),s/veh	57.5	35.7	0.0	33.5	0.0	175.0	62.1	30.8	35.4	58.2	15.3	0.0
LnGrp LOS	E	D		C	A	F	E	C	D	E	B	
Approach Vol, veh/h		164	A		525			2336			969	A
Approach Delay, s/veh		54.8			154.5			32.5			19.6	
Approach LOS		D			F			C			B	
Timer - Assigned Phs	1	2	3	4	5	6	7	8				
Phs Duration (G+Y+Rc), s	10.1	68.0	10.0	32.0	6.8	71.3	11.9	30.0				
Change Period (Y+Rc), s	5.0	7.0	4.5	5.0	5.0	7.0	5.0	5.0				
Max Green Setting (Gmax), s	7.0	56.0	10.5	25.0	7.0	56.0	10.0	25.0				
Max Q Clear Time (g_c+I1), s	5.3	48.4	5.9	3.0	2.9	13.3	6.9	29.0				
Green Ext Time (p_c), s	0.0	6.5	0.1	0.0	0.0	6.0	0.1	0.0				

Intersection Summary

HCM 6th Ctrl Delay	46.4
HCM 6th LOS	D

Notes

Unsignalized Delay for [EBR, SBR] is excluded from calculations of the approach delay and intersection delay.

HCM 6th TWSC
8: Bayou Gulch Rd & Pinery Pkwy

2025 Total
AM Peak

Intersection												
Int Delay, s/veh	6.3											
Movement	EBL	EBT	EBR	WBL	WBT	WBR	NBL	NBT	NBR	SBL	SBT	SBR
Lane Configurations	↘	↑	↗	↘	↑	↗	↘	↑↑	↗	↘	↑↑	↗
Traffic Vol, veh/h	3	77	8	15	58	71	11	100	16	50	56	11
Future Vol, veh/h	3	77	8	15	58	71	11	100	16	50	56	11
Conflicting Peds, #/hr	0	0	0	0	0	0	0	0	0	0	0	0
Sign Control	Stop	Stop	Stop	Stop	Stop	Stop	Free	Free	Free	Free	Free	Free
RT Channelized	-	-	None	-	-	None	-	-	None	-	-	None
Storage Length	150	-	0	150	-	0	150	-	150	150	-	150
Veh in Median Storage, #	-	0	-	-	0	-	-	0	-	-	0	-
Grade, %	-	0	-	-	0	-	-	0	-	-	0	-
Peak Hour Factor	92	92	92	92	92	92	92	92	92	92	92	92
Heavy Vehicles, %	2	2	2	2	2	2	2	2	2	2	2	2
Mvmt Flow	3	84	9	16	63	77	12	109	17	54	61	12

Major/Minor	Minor2		Minor1		Major1			Major2				
Conflicting Flow All	279	319	31	314	314	55	73	0	0	126	0	0
Stage 1	169	169	-	133	133	-	-	-	-	-	-	-
Stage 2	110	150	-	181	181	-	-	-	-	-	-	-
Critical Hdwy	7.54	6.54	6.94	7.54	6.54	6.94	4.14	-	-	4.14	-	-
Critical Hdwy Stg 1	6.54	5.54	-	6.54	5.54	-	-	-	-	-	-	-
Critical Hdwy Stg 2	6.54	5.54	-	6.54	5.54	-	-	-	-	-	-	-
Follow-up Hdwy	3.52	4.02	3.32	3.52	4.02	3.32	2.22	-	-	2.22	-	-
Pot Cap-1 Maneuver	651	596	1036	615	600	1000	1525	-	-	1458	-	-
Stage 1	816	758	-	857	785	-	-	-	-	-	-	-
Stage 2	883	772	-	803	749	-	-	-	-	-	-	-
Platoon blocked, %	-	-	-	-	-	-	-	-	-	-	-	-
Mov Cap-1 Maneuver	532	569	1036	523	573	1000	1525	-	-	1458	-	-
Mov Cap-2 Maneuver	532	569	-	523	573	-	-	-	-	-	-	-
Stage 1	809	730	-	850	779	-	-	-	-	-	-	-
Stage 2	743	766	-	679	721	-	-	-	-	-	-	-

Approach	EB		WB		NB			SB		
HCM Control Delay, s	12		10.5		0.6			3.2		
HCM LOS	B		B							

Minor Lane/Major Mvmt	NBL	NBT	NBR	EBLn1	EBLn2	EBLn3	WBLn1	WBLn2	WBLn3	SBL	SBT	SBR
Capacity (veh/h)	1525	-	-	532	569	1036	523	573	1000	1458	-	-
HCM Lane V/C Ratio	0.008	-	-	0.006	0.147	0.008	0.031	0.11	0.077	0.037	-	-
HCM Control Delay (s)	7.4	-	-	11.8	12.4	8.5	12.1	12.1	8.9	7.6	-	-
HCM Lane LOS	A	-	-	B	B	A	B	B	A	A	-	-
HCM 95th %tile Q(veh)	0	-	-	0	0.5	0	0.1	0.4	0.2	0.1	-	-

HCM 6th TWSC
 25: Bayou Gulch Rd & South Access

2025 Total
 AM Peak

Intersection

Int Delay, s/veh 0.1

Movement EBL EBR NBL NBT SBT SBR

Lane Configurations		↗		↑↑	↑↑	
Traffic Vol, veh/h	0	3	0	76	83	15
Future Vol, veh/h	0	3	0	76	83	15
Conflicting Peds, #/hr	0	0	0	0	0	0
Sign Control	Stop	Stop	Free	Free	Free	Free
RT Channelized	-	None	-	None	-	None
Storage Length	-	0	-	-	-	-
Veh in Median Storage, #	0	-	-	0	0	-
Grade, %	0	-	-	0	0	-
Peak Hour Factor	92	92	92	92	92	92
Heavy Vehicles, %	2	2	2	2	2	2
Mvmt Flow	0	3	0	83	90	16

Major/Minor Minor2 Major1 Major2

Conflicting Flow All	-	53	-	0	-	0
Stage 1	-	-	-	-	-	-
Stage 2	-	-	-	-	-	-
Critical Hdwy	-	6.94	-	-	-	-
Critical Hdwy Stg 1	-	-	-	-	-	-
Critical Hdwy Stg 2	-	-	-	-	-	-
Follow-up Hdwy	-	3.32	-	-	-	-
Pot Cap-1 Maneuver	0	1003	0	-	-	-
Stage 1	0	-	0	-	-	-
Stage 2	0	-	0	-	-	-
Platoon blocked, %				-	-	-
Mov Cap-1 Maneuver	-	1003	-	-	-	-
Mov Cap-2 Maneuver	-	-	-	-	-	-
Stage 1	-	-	-	-	-	-
Stage 2	-	-	-	-	-	-

Approach EB NB SB

HCM Control Delay, s	8.6	0	0
HCM LOS	A		

Minor Lane/Major Mvmt NBT EBLn1 SBT SBR

Capacity (veh/h)	-	1003	-	-
HCM Lane V/C Ratio	-	0.003	-	-
HCM Control Delay (s)	-	8.6	-	-
HCM Lane LOS	-	A	-	-
HCM 95th %tile Q(veh)	-	0	-	-

HCM 6th TWSC
41: PA 40 West/PA 34 West & Pinery Pkwy

2025 Total
AM Peak

Intersection

Int Delay, s/veh 3.5

Movement	EBL	EBT	EBR	WBL	WBT	WBR	NBL	NBT	NBR	SBL	SBT	SBR
Lane Configurations	↙	↑	↗	↙	↑			↕			↕	
Traffic Vol, veh/h	9	51	22	2	155	2	68	0	6	5	0	29
Future Vol, veh/h	9	51	22	2	155	2	68	0	6	5	0	29
Conflicting Peds, #/hr	0	0	0	0	0	0	0	0	0	0	0	0
Sign Control	Free	Free	Free	Free	Free	Free	Stop	Stop	Stop	Stop	Stop	Stop
RT Channelized	-	-	None	-	-	None	-	-	None	-	-	None
Storage Length	150	-	0	150	-	-	-	-	-	-	-	-
Veh in Median Storage, #	-	0	-	-	0	-	-	0	-	-	0	-
Grade, %	-	0	-	-	0	-	-	0	-	-	0	-
Peak Hour Factor	92	92	92	92	92	92	92	92	92	92	92	92
Heavy Vehicles, %	2	2	2	2	2	2	2	2	2	2	2	2
Mvmt Flow	10	55	24	2	168	2	74	0	7	5	0	32

Major/Minor	Major1			Major2			Minor1			Minor2		
Conflicting Flow All	170	0	0	79	0	0	264	249	55	264	272	169
Stage 1	-	-	-	-	-	-	75	75	-	173	173	-
Stage 2	-	-	-	-	-	-	189	174	-	91	99	-
Critical Hdwy	4.12	-	-	4.12	-	-	7.12	6.52	6.22	7.12	6.52	6.22
Critical Hdwy Stg 1	-	-	-	-	-	-	6.12	5.52	-	6.12	5.52	-
Critical Hdwy Stg 2	-	-	-	-	-	-	6.12	5.52	-	6.12	5.52	-
Follow-up Hdwy	2.218	-	-	2.218	-	-	3.518	4.018	3.318	3.518	4.018	3.318
Pot Cap-1 Maneuver	1407	-	-	1519	-	-	689	654	1012	689	635	875
Stage 1	-	-	-	-	-	-	934	833	-	829	756	-
Stage 2	-	-	-	-	-	-	813	755	-	916	813	-
Platoon blocked, %	-	-	-	-	-	-	-	-	-	-	-	-
Mov Cap-1 Maneuver	1407	-	-	1519	-	-	660	649	1012	680	630	875
Mov Cap-2 Maneuver	-	-	-	-	-	-	660	649	-	680	630	-
Stage 1	-	-	-	-	-	-	927	827	-	823	755	-
Stage 2	-	-	-	-	-	-	783	754	-	904	807	-

Approach	EB			WB			NB			SB		
HCM Control Delay, s	0.8			0.1			11			9.5		
HCM LOS							B			A		

Minor Lane/Major Mvmt	NBLn1	EBL	EBT	EBR	WBL	WBT	WBR	SBLn1
Capacity (veh/h)	679	1407	-	-	1519	-	-	840
HCM Lane V/C Ratio	0.118	0.007	-	-	0.001	-	-	0.044
HCM Control Delay (s)	11	7.6	-	-	7.4	-	-	9.5
HCM Lane LOS	B	A	-	-	A	-	-	A
HCM 95th %tile Q(veh)	0.4	0	-	-	0	-	-	0.1

HCM 6th TWSC
42: PA 40 East/PA 34 East & Pinery Pkwy

2025 Total
AM Peak

Intersection												
Int Delay, s/veh	5.4											
Movement	EBL	EBT	EBR	WBL	WBT	WBR	NBL	NBT	NBR	SBL	SBT	SBR
Lane Configurations	↖	↗		↖	↗			↕			↕	
Traffic Vol, veh/h	8	41	13	6	60	3	73	0	32	10	0	26
Future Vol, veh/h	8	41	13	6	60	3	73	0	32	10	0	26
Conflicting Peds, #/hr	0	0	0	0	0	0	0	0	0	0	0	0
Sign Control	Free	Free	Free	Free	Free	Free	Stop	Stop	Stop	Stop	Stop	Stop
RT Channelized	-	-	None	-	-	None	-	-	None	-	-	None
Storage Length	150	-	-	150	-	-	-	-	-	-	-	-
Veh in Median Storage, #	-	0	-	-	0	-	-	0	-	-	0	-
Grade, %	-	0	-	-	0	-	-	0	-	-	0	-
Peak Hour Factor	92	92	92	92	92	92	92	92	92	92	92	92
Heavy Vehicles, %	2	2	2	2	2	2	2	2	2	2	2	2
Mvmt Flow	9	45	14	7	65	3	79	0	35	11	0	28

Major/Minor	Major1			Major2			Minor1			Minor2		
Conflicting Flow All	68	0	0	59	0	0	165	152	52	169	158	67
Stage 1	-	-	-	-	-	-	70	70	-	81	81	-
Stage 2	-	-	-	-	-	-	95	82	-	88	77	-
Critical Hdwy	4.12	-	-	4.12	-	-	7.12	6.52	6.22	7.12	6.52	6.22
Critical Hdwy Stg 1	-	-	-	-	-	-	6.12	5.52	-	6.12	5.52	-
Critical Hdwy Stg 2	-	-	-	-	-	-	6.12	5.52	-	6.12	5.52	-
Follow-up Hdwy	2.218	-	-	2.218	-	-	3.518	4.018	3.318	3.518	4.018	3.318
Pot Cap-1 Maneuver	1533	-	-	1545	-	-	800	740	1016	795	734	997
Stage 1	-	-	-	-	-	-	940	837	-	927	828	-
Stage 2	-	-	-	-	-	-	912	827	-	920	831	-
Platoon blocked, %	-	-	-	-	-	-	-	-	-	-	-	-
Mov Cap-1 Maneuver	1533	-	-	1545	-	-	771	732	1016	762	726	997
Mov Cap-2 Maneuver	-	-	-	-	-	-	771	732	-	762	726	-
Stage 1	-	-	-	-	-	-	934	832	-	921	824	-
Stage 2	-	-	-	-	-	-	882	823	-	883	826	-

Approach	EB			WB			NB			SB		
HCM Control Delay, s	0.9			0.6			10			9.1		
HCM LOS							B			A		

Minor Lane/Major Mvmt	NBLn1	EBL	EBT	EBR	WBL	WBT	WBR	SBLn1
Capacity (veh/h)	832	1533	-	-	1545	-	-	918
HCM Lane V/C Ratio	0.137	0.006	-	-	0.004	-	-	0.043
HCM Control Delay (s)	10	7.4	-	-	7.3	-	-	9.1
HCM Lane LOS	B	A	-	-	A	-	-	A
HCM 95th %tile Q(veh)	0.5	0	-	-	0	-	-	0.1

HCM 6th TWSC
43: Three-Quarter Access & Pinery Pkwy

2025 Total
AM Peak

Intersection												
Int Delay, s/veh	0.6											
Movement	EBL	EBT	EBR	WBL	WBT	WBR	NBL	NBT	NBR	SBL	SBT	SBR
Lane Configurations	↖	↑	↗	↖	↗				↗			↗
Traffic Vol, veh/h	1	98	44	5	140	1	0	0	11	0	0	4
Future Vol, veh/h	1	98	44	5	140	1	0	0	11	0	0	4
Conflicting Peds, #/hr	0	0	0	0	0	0	0	0	0	0	0	0
Sign Control	Free	Free	Free	Free	Free	Free	Stop	Stop	Stop	Stop	Stop	Stop
RT Channelized	-	-	None	-	-	None	-	-	None	-	-	None
Storage Length	150	-	0	150	-	-	-	-	0	-	-	0
Veh in Median Storage, #	-	0	-	-	0	-	-	0	-	-	0	-
Grade, %	-	0	-	-	0	-	-	0	-	-	0	-
Peak Hour Factor	92	92	92	92	92	92	92	92	92	92	92	92
Heavy Vehicles, %	2	2	2	2	2	2	2	2	2	2	2	2
Mvmt Flow	1	107	48	5	152	1	0	0	12	0	0	4

Major/Minor	Major1			Major2			Minor1			Minor2		
Conflicting Flow All	153	0	0	155	0	0	-	-	107	-	-	153
Stage 1	-	-	-	-	-	-	-	-	-	-	-	-
Stage 2	-	-	-	-	-	-	-	-	-	-	-	-
Critical Hdwy	4.12	-	-	4.12	-	-	-	-	6.22	-	-	6.22
Critical Hdwy Stg 1	-	-	-	-	-	-	-	-	-	-	-	-
Critical Hdwy Stg 2	-	-	-	-	-	-	-	-	-	-	-	-
Follow-up Hdwy	2.218	-	-	2.218	-	-	-	-	3.318	-	-	3.318
Pot Cap-1 Maneuver	1428	-	-	1425	-	-	0	0	947	0	0	893
Stage 1	-	-	-	-	-	-	0	0	-	0	0	-
Stage 2	-	-	-	-	-	-	0	0	-	0	0	-
Platoon blocked, %	-	-	-	-	-	-	-	-	-	-	-	-
Mov Cap-1 Maneuver	1428	-	-	1425	-	-	-	-	947	-	-	893
Mov Cap-2 Maneuver	-	-	-	-	-	-	-	-	-	-	-	-
Stage 1	-	-	-	-	-	-	-	-	-	-	-	-
Stage 2	-	-	-	-	-	-	-	-	-	-	-	-

Approach	EB			WB			NB			SB		
HCM Control Delay, s	0.1			0.3			8.9			9.1		
HCM LOS							A			A		

Minor Lane/Major Mvmt	NBLn1	EBL	EBT	EBR	WBL	WBT	WBR	SBLn1
Capacity (veh/h)	947	1428	-	-	1425	-	-	893
HCM Lane V/C Ratio	0.013	0.001	-	-	0.004	-	-	0.005
HCM Control Delay (s)	8.9	7.5	-	-	7.5	-	-	9.1
HCM Lane LOS	A	A	-	-	A	-	-	A
HCM 95th %tile Q(veh)	0	0	-	-	0	-	-	0

HCM 6th TWSC
44: PA 46/PA 47 & Pinery Pkwy

2025 Total
AM Peak

Intersection												
Int Delay, s/veh	4.3											
Movement	EBL	EBT	EBR	WBL	WBT	WBR	NBL	NBT	NBR	SBL	SBT	SBR
Lane Configurations	↶	↷		↶	↷			↕			↕	
Traffic Vol, veh/h	3	96	10	19	75	10	59	1	19	33	0	11
Future Vol, veh/h	3	96	10	19	75	10	59	1	19	33	0	11
Conflicting Peds, #/hr	0	0	0	0	0	0	0	0	0	0	0	0
Sign Control	Free	Free	Free	Free	Free	Free	Stop	Stop	Stop	Stop	Stop	Stop
RT Channelized	-	-	None	-	-	None	-	-	None	-	-	None
Storage Length	0	-	-	0	-	-	-	-	-	-	-	-
Veh in Median Storage, #	-	0	-	-	0	-	-	0	-	-	0	-
Grade, %	-	0	-	-	0	-	-	0	-	-	0	-
Peak Hour Factor	92	92	92	92	92	92	92	92	92	92	92	92
Heavy Vehicles, %	2	2	2	2	2	2	2	2	2	2	2	2
Mvmt Flow	3	104	11	21	82	11	64	1	21	36	0	12

Major/Minor	Major1			Major2			Minor1			Minor2		
Conflicting Flow All	93	0	0	115	0	0	252	251	110	257	251	88
Stage 1	-	-	-	-	-	-	116	116	-	130	130	-
Stage 2	-	-	-	-	-	-	136	135	-	127	121	-
Critical Hdwy	4.12	-	-	4.12	-	-	7.12	6.52	6.22	7.12	6.52	6.22
Critical Hdwy Stg 1	-	-	-	-	-	-	6.12	5.52	-	6.12	5.52	-
Critical Hdwy Stg 2	-	-	-	-	-	-	6.12	5.52	-	6.12	5.52	-
Follow-up Hdwy	2.218	-	-	2.218	-	-	3.518	4.018	3.318	3.518	4.018	3.318
Pot Cap-1 Maneuver	1501	-	-	1474	-	-	701	652	943	696	652	970
Stage 1	-	-	-	-	-	-	889	800	-	874	789	-
Stage 2	-	-	-	-	-	-	867	785	-	877	796	-
Platoon blocked, %		-	-		-	-						
Mov Cap-1 Maneuver	1501	-	-	1474	-	-	683	642	943	672	642	970
Mov Cap-2 Maneuver	-	-	-	-	-	-	683	642	-	672	642	-
Stage 1	-	-	-	-	-	-	887	798	-	872	778	-
Stage 2	-	-	-	-	-	-	844	774	-	855	794	-

Approach	EB			WB			NB			SB		
HCM Control Delay, s	0.2			1.4			10.6			10.3		
HCM LOS							B			B		

Minor Lane/Major Mvmt	NBLn1	EBL	EBT	EBR	WBL	WBT	WBR	SBLn1
Capacity (veh/h)	731	1501	-	-	1474	-	-	728
HCM Lane V/C Ratio	0.117	0.002	-	-	0.014	-	-	0.066
HCM Control Delay (s)	10.6	7.4	-	-	7.5	-	-	10.3
HCM Lane LOS	B	A	-	-	A	-	-	B
HCM 95th %tile Q(veh)	0.4	0	-	-	0	-	-	0.2

HCM 6th TWSC
 48: Bayou Gulch Rd & PA-36&37/PA 34&35

2025 Total
 AM Peak

Intersection

Int Delay, s/veh 3.6

Movement	EBL	EBT	EBR	WBL	WBT	WBR	NBL	NBT	NBR	SBL	SBT	SBR
Lane Configurations	↙	↘		↙	↘	↙	↙	↕	↙	↙	↕	↙
Traffic Vol, veh/h	45	0	15	8	0	75	4	166	3	23	92	15
Future Vol, veh/h	45	0	15	8	0	75	4	166	3	23	92	15
Conflicting Peds, #/hr	0	0	0	0	0	0	0	0	0	0	0	0
Sign Control	Stop	Stop	Stop	Stop	Stop	Stop	Free	Free	Free	Free	Free	Free
RT Channelized	-	-	None	-	-	None	-	-	None	-	-	None
Storage Length	0	-	-	0	-	150	150	-	150	150	-	150
Veh in Median Storage, #	-	0	-	-	0	-	-	0	-	-	0	-
Grade, %	-	0	-	-	0	-	-	0	-	-	0	-
Peak Hour Factor	92	92	92	92	92	92	92	92	92	92	92	92
Heavy Vehicles, %	2	2	2	2	2	2	2	2	2	2	2	2
Mvmt Flow	49	0	16	9	0	82	4	180	3	25	100	16

Major/Minor	Minor2		Minor1		Major1		Major2					
Conflicting Flow All	248	341	50	288	354	90	116	0	0	183	0	0
Stage 1	150	150	-	188	188	-	-	-	-	-	-	-
Stage 2	98	191	-	100	166	-	-	-	-	-	-	-
Critical Hdwy	7.54	6.54	6.94	7.54	6.54	6.94	4.14	-	-	4.14	-	-
Critical Hdwy Stg 1	6.54	5.54	-	6.54	5.54	-	-	-	-	-	-	-
Critical Hdwy Stg 2	6.54	5.54	-	6.54	5.54	-	-	-	-	-	-	-
Follow-up Hdwy	3.52	4.02	3.32	3.52	4.02	3.32	2.22	-	-	2.22	-	-
Pot Cap-1 Maneuver	685	580	1008	642	570	950	1470	-	-	1389	-	-
Stage 1	837	772	-	796	743	-	-	-	-	-	-	-
Stage 2	898	741	-	895	760	-	-	-	-	-	-	-
Platoon blocked, %								-	-	-	-	-
Mov Cap-1 Maneuver	617	568	1008	621	558	950	1470	-	-	1389	-	-
Mov Cap-2 Maneuver	617	568	-	621	558	-	-	-	-	-	-	-
Stage 1	834	758	-	794	741	-	-	-	-	-	-	-
Stage 2	819	739	-	865	746	-	-	-	-	-	-	-

Approach	EB		WB		NB		SB	
HCM Control Delay, s	10.6		9.3		0.2		1.4	
HCM LOS	B		A					

Minor Lane/Major Mvmt	NBL	NBT	NBR	EBLn1	EBLn2	WBLn1	WBLn2	WBLn3	SBL	SBT	SBR
Capacity (veh/h)	1470	-	-	617	1008	621	-	950	1389	-	-
HCM Lane V/C Ratio	0.003	-	-	0.079	0.016	0.014	-	0.086	0.018	-	-
HCM Control Delay (s)	7.5	-	-	11.3	8.6	10.9	0	9.1	7.6	-	-
HCM Lane LOS	A	-	-	B	A	B	A	A	A	-	-
HCM 95th %tile Q(veh)	0	-	-	0.3	0	0	-	0.3	0.1	-	-

HCM 6th Signalized Intersection Summary

2: Crowfoot Valley Rd/Motsenbocker Rd & Stroh Rd

2025 Total
PM Peak



Movement	WBL	WBR	NBT	NBR	SBL	SBT
Lane Configurations						
Traffic Volume (veh/h)	246	145	469	199	350	700
Future Volume (veh/h)	246	145	469	199	350	700
Initial Q (Qb), veh	0	0	0	0	0	0
Ped-Bike Adj(A_pbT)	1.00	1.00		1.00	1.00	
Parking Bus, Adj	1.00	1.00	1.00	1.00	1.00	1.00
Work Zone On Approach	No		No			No
Adj Sat Flow, veh/h/ln	1870	1870	1870	1870	1870	1870
Adj Flow Rate, veh/h	267	158	510	216	380	761
Peak Hour Factor	0.92	0.92	0.92	0.92	0.92	0.92
Percent Heavy Veh, %	2	2	2	2	2	2
Cap, veh/h	332	295	898	761	476	1210
Arrive On Green	0.19	0.19	0.48	0.48	0.08	0.65
Sat Flow, veh/h	1781	1585	1870	1585	1781	1870
Grp Volume(v), veh/h	267	158	510	216	380	761
Grp Sat Flow(s),veh/h/ln	1781	1585	1870	1585	1781	1870
Q Serve(g_s), s	8.6	5.4	11.7	4.9	5.0	14.5
Cycle Q Clear(g_c), s	8.6	5.4	11.7	4.9	5.0	14.5
Prop In Lane	1.00	1.00		1.00	1.00	
Lane Grp Cap(c), veh/h	332	295	898	761	476	1210
V/C Ratio(X)	0.80	0.53	0.57	0.28	0.80	0.63
Avail Cap(c_a), veh/h	445	396	898	761	476	1210
HCM Platoon Ratio	1.00	1.00	1.00	1.00	1.00	1.00
Upstream Filter(I)	1.00	1.00	1.00	1.00	1.00	1.00
Uniform Delay (d), s/veh	23.4	22.1	11.1	9.4	12.3	6.3
Incr Delay (d2), s/veh	7.6	1.5	2.6	0.9	9.2	2.5
Initial Q Delay(d3),s/veh	0.0	0.0	0.0	0.0	0.0	0.0
%ile BackOfQ(50%),veh/ln	3.9	1.9	4.5	1.6	3.0	4.4
Unsig. Movement Delay, s/veh						
LnGrp Delay(d),s/veh	31.0	23.6	13.7	10.3	21.5	8.8
LnGrp LOS	C	C	B	B	C	A
Approach Vol, veh/h	425		726			1141
Approach Delay, s/veh	28.2		12.7			13.0
Approach LOS	C		B			B
Timer - Assigned Phs	1	2			6	8
Phs Duration (G+Y+Rc), s	10.0	33.8			43.8	16.2
Change Period (Y+Rc), s	5.0	5.0			5.0	5.0
Max Green Setting (Gmax), s	5.0	25.0			35.0	15.0
Max Q Clear Time (g_c+I1), s	7.0	13.7			16.5	10.6
Green Ext Time (p_c), s	0.0	3.0			5.1	0.6
Intersection Summary						
HCM 6th Ctrl Delay			15.8			
HCM 6th LOS			B			

HCM Unsignalized Intersection Capacity Analysis

3: Crowfoot Valley Rd & Bayou Gulch Rd

2025 Total
PM Peak



Movement	WBL	WBR	NBT	NBR	SBL	SBT
Lane Configurations						
Traffic Volume (veh/h)	4	205	465	9	356	545
Future Volume (Veh/h)	4	205	465	9	356	545
Sign Control	Stop		Free		Free	
Grade	0%		0%		0%	
Peak Hour Factor	0.92	0.92	0.92	0.92	0.92	0.92
Hourly flow rate (vph)	4	223	505	10	387	592
Pedestrians						
Lane Width (ft)						
Walking Speed (ft/s)						
Percent Blockage						
Right turn flare (veh)						
Median type	TWLTL			None		
Median storage (veh)	2					
Upstream signal (ft)						
pX, platoon unblocked						
vC, conflicting volume	1871	505			515	
vC1, stage 1 conf vol	505					
vC2, stage 2 conf vol	1366					
vCu, unblocked vol	1871	505			515	
tC, single (s)	6.4	6.2			4.1	
tC, 2 stage (s)	5.4					
tF (s)	3.5	3.3			2.2	
p0 queue free %	97	61			63	
cM capacity (veh/h)	144	567			1051	
Direction, Lane #	WB 1	WB 2	NB 1	NB 2	SB 1	SB 2
Volume Total	4	223	505	10	387	592
Volume Left	4	0	0	0	387	0
Volume Right	0	223	0	10	0	0
cSH	144	567	1700	1700	1051	1700
Volume to Capacity	0.03	0.39	0.30	0.01	0.37	0.35
Queue Length 95th (ft)	2	47	0	0	43	0
Control Delay (s)	30.8	15.4	0.0	0.0	10.4	0.0
Lane LOS	D	C			B	
Approach Delay (s)	15.7		0.0		4.1	
Approach LOS	C					
Intersection Summary						
Average Delay			4.4			
Intersection Capacity Utilization			57.5%		ICU Level of Service	B
Analysis Period (min)			15			

HCM 6th TWSC
4: Crowfoot Valley Rd & Pinery Pkwy

2025 Total
PM Peak

Intersection

Int Delay, s/veh 2.8

Movement	WBL	WBR	NBT	NBR	SBL	SBT
----------	-----	-----	-----	-----	-----	-----

Lane Configurations	↘	↗	↑	↗	↘	↑
Traffic Vol, veh/h	59	107	366	83	159	390
Future Vol, veh/h	59	107	366	83	159	390
Conflicting Peds, #/hr	0	0	0	0	0	0
Sign Control	Stop	Stop	Free	Free	Free	Free
RT Channelized	-	Free	-	None	-	None
Storage Length	200	0	-	200	200	-
Veh in Median Storage, #	0	-	0	-	-	0
Grade, %	0	-	0	-	-	0
Peak Hour Factor	92	92	92	92	92	92
Heavy Vehicles, %	2	2	2	2	2	2
Mvmt Flow	64	116	398	90	173	424

Major/Minor	Minor1	Major1	Major2
-------------	--------	--------	--------

Conflicting Flow All	1168	-	0	0	488	0
Stage 1	398	-	-	-	-	-
Stage 2	770	-	-	-	-	-
Critical Hdwy	6.42	-	-	-	4.12	-
Critical Hdwy Stg 1	5.42	-	-	-	-	-
Critical Hdwy Stg 2	5.42	-	-	-	-	-
Follow-up Hdwy	3.518	-	-	-	2.218	-
Pot Cap-1 Maneuver	214	0	-	-	1075	-
Stage 1	678	0	-	-	-	-
Stage 2	457	0	-	-	-	-
Platoon blocked, %						
Mov Cap-1 Maneuver	180	-	-	-	1075	-
Mov Cap-2 Maneuver	239	-	-	-	-	-
Stage 1	569	-	-	-	-	-
Stage 2	457	-	-	-	-	-

Approach	WB	NB	SB
----------	----	----	----

HCM Control Delay, s	25.5	0	2.6
HCM LOS	D		

Minor Lane/Major Mvmt	NBT	NBR	WBLn1	WBLn2	SBL	SBT
-----------------------	-----	-----	-------	-------	-----	-----

Capacity (veh/h)	-	-	239	-	1075	-
HCM Lane V/C Ratio	-	-	0.268	-	0.161	-
HCM Control Delay (s)	-	-	25.5	0	9	-
HCM Lane LOS	-	-	D	A	A	-
HCM 95th %tile Q(veh)	-	-	1	-	0.6	-

HCM 6th TWSC
5: Crowfoot Valley Rd & Pradera Pkwy

2025 Total
PM Peak

Intersection

Int Delay, s/veh 2.5

Movement WBL WBR NBT NBR SBL SBT

Lane Configurations	↘	↗	↑	↗	↘	↑
Traffic Vol, veh/h	94	39	419	139	62	386
Future Vol, veh/h	94	39	419	139	62	386
Conflicting Peds, #/hr	0	0	0	0	0	0
Sign Control	Stop	Stop	Free	Free	Free	Free
RT Channelized	-	None	-	None	-	None
Storage Length	230	0	-	350	350	-
Veh in Median Storage, #	0	-	0	-	-	0
Grade, %	0	-	0	-	-	0
Peak Hour Factor	90	90	90	90	90	90
Heavy Vehicles, %	2	2	2	2	2	2
Mvmt Flow	104	43	466	154	69	429

Major/Minor Minor1 Major1 Major2

Conflicting Flow All	1033	466	0	0	620	0
Stage 1	466	-	-	-	-	-
Stage 2	567	-	-	-	-	-
Critical Hdwy	6.42	6.22	-	-	4.12	-
Critical Hdwy Stg 1	5.42	-	-	-	-	-
Critical Hdwy Stg 2	5.42	-	-	-	-	-
Follow-up Hdwy	3.518	3.318	-	-	2.218	-
Pot Cap-1 Maneuver	258	597	-	-	960	-
Stage 1	632	-	-	-	-	-
Stage 2	568	-	-	-	-	-
Platoon blocked, %			-	-	-	-
Mov Cap-1 Maneuver	239	597	-	-	960	-
Mov Cap-2 Maneuver	354	-	-	-	-	-
Stage 1	586	-	-	-	-	-
Stage 2	568	-	-	-	-	-

Approach WB NB SB

HCM Control Delay, s	17.1	0	1.3
HCM LOS	C		

Minor Lane/Major Mvmt NBT NBRWBLn1WBLn2 SBL SBT

Capacity (veh/h)	-	-	354	597	960	-
HCM Lane V/C Ratio	-	-	0.295	0.073	0.072	-
HCM Control Delay (s)	-	-	19.4	11.5	9	-
HCM Lane LOS	-	-	C	B	A	-
HCM 95th %tile Q(veh)	-	-	1.2	0.2	0.2	-

HCM 6th Signalized Intersection Summary
7: Parker Rd & Pinery Pkwy

2025 Total
PM Peak

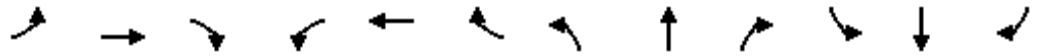

Movement	EBL	EBT	EBR	WBL	WBT	WBR	NBL	NBT	NBR	SBL	SBT	SBR
Lane Configurations	↖↗	↑	↖	↖	↗		↖	↑↑↑		↖↗	↑↑↑	↖
Traffic Volume (veh/h)	121	57	14	46	30	206	16	1143	32	458	1976	179
Future Volume (veh/h)	121	57	14	46	30	206	16	1143	32	458	1976	179
Initial Q (Qb), veh	0	0	0	0	0	0	0	0	0	0	0	0
Ped-Bike Adj(A_pbT)	1.00		1.00	1.00		1.00	1.00		1.00	1.00		1.00
Parking Bus, Adj	1.00	1.00	1.00	1.00	1.00	1.00	1.00	1.00	1.00	1.00	1.00	1.00
Work Zone On Approach		No			No			No			No	
Adj Sat Flow, veh/h/ln	1870	1870	1870	1870	1870	1870	1870	1870	1870	1870	1870	1870
Adj Flow Rate, veh/h	129	61	0	49	32	219	17	1216	34	487	2102	0
Peak Hour Factor	0.94	0.94	0.94	0.94	0.94	0.94	0.94	0.94	0.94	0.94	0.94	0.94
Percent Heavy Veh, %	2	2	2	2	2	2	2	2	2	2	2	2
Cap, veh/h	187	257		265	26	176	32	2496	70	571	3248	
Arrive On Green	0.05	0.14	0.00	0.03	0.13	0.13	0.02	0.49	0.49	0.17	0.64	0.00
Sat Flow, veh/h	3456	1870	1585	1781	206	1410	1781	5106	143	3456	5106	1585
Grp Volume(v), veh/h	129	61	0	49	0	251	17	811	439	487	2102	0
Grp Sat Flow(s),veh/h/ln	1728	1870	1585	1781	0	1616	1781	1702	1845	1728	1702	1585
Q Serve(g_s), s	4.4	3.5	0.0	2.9	0.0	15.0	1.1	19.2	19.2	16.4	30.6	0.0
Cycle Q Clear(g_c), s	4.4	3.5	0.0	2.9	0.0	15.0	1.1	19.2	19.2	16.4	30.6	0.0
Prop In Lane	1.00		1.00	1.00		0.87	1.00		0.08	1.00		1.00
Lane Grp Cap(c), veh/h	187	257		265	0	202	32	1664	902	571	3248	
V/C Ratio(X)	0.69	0.24		0.18	0.00	1.24	0.53	0.49	0.49	0.85	0.65	
Avail Cap(c_a), veh/h	187	257		287	0	202	111	1664	902	907	3248	
HCM Platoon Ratio	1.00	1.00	1.00	1.00	1.00	1.00	1.00	1.00	1.00	1.00	1.00	1.00
Upstream Filter(I)	1.00	1.00	0.00	1.00	0.00	1.00	1.00	1.00	1.00	0.46	0.46	0.00
Uniform Delay (d), s/veh	55.8	46.2	0.0	43.7	0.0	52.5	58.4	20.6	20.6	48.7	13.5	0.0
Incr Delay (d2), s/veh	10.2	0.5	0.0	0.3	0.0	143.7	12.9	1.0	1.9	2.2	0.5	0.0
Initial Q Delay(d3),s/veh	0.0	0.0	0.0	0.0	0.0	0.0	0.0	0.0	0.0	0.0	0.0	0.0
%ile BackOfQ(50%),veh/ln	2.2	1.7	0.0	1.3	0.0	14.2	0.6	7.2	8.0	6.9	9.8	0.0
Unsig. Movement Delay, s/veh												
LnGrp Delay(d),s/veh	65.9	46.6	0.0	44.0	0.0	196.2	71.3	21.6	22.5	50.9	14.0	0.0
LnGrp LOS	E	D		D	A	F	E	C	C	D	B	
Approach Vol, veh/h		190	A		300			1267			2589	A
Approach Delay, s/veh		59.7			171.3			22.6			20.9	
Approach LOS		E			F			C			C	
Timer - Assigned Phs	1	2	3	4	5	6	7	8				
Phs Duration (G+Y+Rc), s	24.3	65.7	8.5	21.5	6.7	83.3	10.0	20.0				
Change Period (Y+Rc), s	4.5	7.0	4.5	5.0	4.5	7.0	4.5	5.0				
Max Green Setting (Gmax), s	31.5	47.0	5.5	15.0	7.5	71.0	5.5	15.0				
Max Q Clear Time (g_c+I1), s	18.4	21.2	4.9	5.5	3.1	32.6	6.4	17.0				
Green Ext Time (p_c), s	1.4	8.0	0.0	0.1	0.0	21.1	0.0	0.0				

Intersection Summary

HCM 6th Ctrl Delay	33.5
HCM 6th LOS	C

Notes

Unsignalized Delay for [EBR, SBR] is excluded from calculations of the approach delay and intersection delay.

HCM 6th TWSC
8: Bayou Gulch Rd & Pinery Pkwy

2025 Total
PM Peak

Intersection												
Int Delay, s/veh	8.7											
Movement	EBL	EBT	EBR	WBL	WBT	WBR	NBL	NBT	NBR	SBL	SBT	SBR
Lane Configurations	↘	↑	↗	↘	↑	↗	↘	↑↑	↗	↘	↑↑	↗
Traffic Vol, veh/h	9	91	14	44	88	114	8	36	35	138	107	7
Future Vol, veh/h	9	91	14	44	88	114	8	36	35	138	107	7
Conflicting Peds, #/hr	0	0	0	0	0	0	0	0	0	0	0	0
Sign Control	Stop	Stop	Stop	Stop	Stop	Stop	Free	Free	Free	Free	Free	Free
RT Channelized	-	-	None	-	-	None	-	-	None	-	-	None
Storage Length	150	-	0	150	-	0	150	-	150	150	-	150
Veh in Median Storage, #	-	0	-	-	0	-	-	0	-	-	0	-
Grade, %	-	0	-	-	0	-	-	0	-	-	0	-
Peak Hour Factor	92	92	92	92	92	92	92	92	92	92	92	92
Heavy Vehicles, %	2	2	2	2	2	2	2	2	2	2	2	2
Mvmt Flow	10	99	15	48	96	124	9	39	38	150	116	8

Major/Minor	Minor2		Minor1		Major1		Major2					
Conflicting Flow All	502	511	58	465	481	20	124	0	0	77	0	0
Stage 1	416	416	-	57	57	-	-	-	-	-	-	-
Stage 2	86	95	-	408	424	-	-	-	-	-	-	-
Critical Hdwy	7.54	6.54	6.94	7.54	6.54	6.94	4.14	-	-	4.14	-	-
Critical Hdwy Stg 1	6.54	5.54	-	6.54	5.54	-	-	-	-	-	-	-
Critical Hdwy Stg 2	6.54	5.54	-	6.54	5.54	-	-	-	-	-	-	-
Follow-up Hdwy	3.52	4.02	3.32	3.52	4.02	3.32	2.22	-	-	2.22	-	-
Pot Cap-1 Maneuver	452	464	996	481	483	1053	1461	-	-	1520	-	-
Stage 1	585	590	-	948	847	-	-	-	-	-	-	-
Stage 2	912	815	-	591	585	-	-	-	-	-	-	-
Platoon blocked, %	-	-	-	-	-	-	-	-	-	-	-	-
Mov Cap-1 Maneuver	306	416	996	357	433	1053	1461	-	-	1520	-	-
Mov Cap-2 Maneuver	306	416	-	357	433	-	-	-	-	-	-	-
Stage 1	581	532	-	942	842	-	-	-	-	-	-	-
Stage 2	709	810	-	427	527	-	-	-	-	-	-	-

Approach	EB		WB		NB		SB				
HCM Control Delay, s	15.4		12.7		0.8		4.2				
HCM LOS	C		B								

Minor Lane/Major Mvmt	NBL	NBT	NBR	EBLn1	EBLn2	EBLn3	WBLn1	WBLn2	WBLn3	SBL	SBT	SBR
Capacity (veh/h)	1461	-	-	306	416	996	357	433	1053	1520	-	-
HCM Lane V/C Ratio	0.006	-	-	0.032	0.238	0.015	0.134	0.221	0.118	0.099	-	-
HCM Control Delay (s)	7.5	-	-	17.2	16.3	8.7	16.6	15.7	8.9	7.6	-	-
HCM Lane LOS	A	-	-	C	C	A	C	C	A	A	-	-
HCM 95th %tile Q(veh)	0	-	-	0.1	0.9	0	0.5	0.8	0.4	0.3	-	-

HCM 6th TWSC
 25: Bayou Gulch Rd & South Access

2025 Total
 PM Peak

Intersection

Int Delay, s/veh 0.1

Movement EBL EBR NBL NBT SBT SBR

Lane Configurations		↗		↑↑	↑↑	
Traffic Vol, veh/h	0	2	0	74	77	51
Future Vol, veh/h	0	2	0	74	77	51
Conflicting Peds, #/hr	0	0	0	0	0	0
Sign Control	Stop	Stop	Free	Free	Free	Free
RT Channelized	-	None	-	None	-	None
Storage Length	-	0	-	-	-	-
Veh in Median Storage, #	0	-	-	0	0	-
Grade, %	0	-	-	0	0	-
Peak Hour Factor	92	92	92	92	92	92
Heavy Vehicles, %	2	2	2	2	2	2
Mvmt Flow	0	2	0	80	84	55

Major/Minor Minor2 Major1 Major2

Conflicting Flow All	-	70	-	0	-	0
Stage 1	-	-	-	-	-	-
Stage 2	-	-	-	-	-	-
Critical Hdwy	-	6.94	-	-	-	-
Critical Hdwy Stg 1	-	-	-	-	-	-
Critical Hdwy Stg 2	-	-	-	-	-	-
Follow-up Hdwy	-	3.32	-	-	-	-
Pot Cap-1 Maneuver	0	978	0	-	-	-
Stage 1	0	-	0	-	-	-
Stage 2	0	-	0	-	-	-
Platoon blocked, %				-	-	-
Mov Cap-1 Maneuver	-	978	-	-	-	-
Mov Cap-2 Maneuver	-	-	-	-	-	-
Stage 1	-	-	-	-	-	-
Stage 2	-	-	-	-	-	-

Approach EB NB SB

HCM Control Delay, s	8.7	0	0
HCM LOS	A		

Minor Lane/Major Mvmt NBT EBLn1 SBT SBR

Capacity (veh/h)	-	978	-	-
HCM Lane V/C Ratio	-	0.002	-	-
HCM Control Delay (s)	-	8.7	-	-
HCM Lane LOS	-	A	-	-
HCM 95th %tile Q(veh)	-	0	-	-

HCM 6th TWSC
 41: PA 40 West/PA 34 West & Pinery Pkwy

2025 Total
 PM Peak

Intersection												
Int Delay, s/veh	2.5											
Movement	EBL	EBT	EBR	WBL	WBT	WBR	NBL	NBT	NBR	SBL	SBT	SBR
Lane Configurations	↙	↑	↗	↙	↗			↕			↕	
Traffic Vol, veh/h	32	137	72	9	106	6	42	0	5	4	0	18
Future Vol, veh/h	32	137	72	9	106	6	42	0	5	4	0	18
Conflicting Peds, #/hr	0	0	0	0	0	0	0	0	0	0	0	0
Sign Control	Free	Free	Free	Free	Free	Free	Stop	Stop	Stop	Stop	Stop	Stop
RT Channelized	-	-	None	-	-	None	-	-	None	-	-	None
Storage Length	150	-	0	150	-	-	-	-	-	-	-	-
Veh in Median Storage, #	-	0	-	-	0	-	-	0	-	-	0	-
Grade, %	-	0	-	-	0	-	-	0	-	-	0	-
Peak Hour Factor	92	92	92	92	92	92	92	92	92	92	92	92
Heavy Vehicles, %	2	2	2	2	2	2	2	2	2	2	2	2
Mvmt Flow	35	149	78	10	115	7	46	0	5	4	0	20

Major/Minor	Major1			Major2			Minor1			Minor2		
Conflicting Flow All	122	0	0	227	0	0	368	361	149	400	436	119
Stage 1	-	-	-	-	-	-	219	219	-	139	139	-
Stage 2	-	-	-	-	-	-	149	142	-	261	297	-
Critical Hdwy	4.12	-	-	4.12	-	-	7.12	6.52	6.22	7.12	6.52	6.22
Critical Hdwy Stg 1	-	-	-	-	-	-	6.12	5.52	-	6.12	5.52	-
Critical Hdwy Stg 2	-	-	-	-	-	-	6.12	5.52	-	6.12	5.52	-
Follow-up Hdwy	2.218	-	-	2.218	-	-	3.518	4.018	3.318	3.518	4.018	3.318
Pot Cap-1 Maneuver	1465	-	-	1341	-	-	588	566	898	560	514	933
Stage 1	-	-	-	-	-	-	783	722	-	864	782	-
Stage 2	-	-	-	-	-	-	854	779	-	744	668	-
Platoon blocked, %	-	-	-	-	-	-	-	-	-	-	-	-
Mov Cap-1 Maneuver	1465	-	-	1341	-	-	562	548	898	543	498	933
Mov Cap-2 Maneuver	-	-	-	-	-	-	562	548	-	543	498	-
Stage 1	-	-	-	-	-	-	764	705	-	843	777	-
Stage 2	-	-	-	-	-	-	830	774	-	722	652	-

Approach	EB			WB			NB			SB		
HCM Control Delay, s	1			0.6			11.7			9.5		
HCM LOS							B			A		

Minor Lane/Major Mvmt	NBLn1	EBL	EBT	EBR	WBL	WBT	WBR	SBLn1
Capacity (veh/h)	585	1465	-	-	1341	-	-	825
HCM Lane V/C Ratio	0.087	0.024	-	-	0.007	-	-	0.029
HCM Control Delay (s)	11.7	7.5	-	-	7.7	-	-	9.5
HCM Lane LOS	B	A	-	-	A	-	-	A
HCM 95th %tile Q(veh)	0.3	0.1	-	-	0	-	-	0.1

HCM 6th TWSC
42: PA 40 East/PA 34 East & Pinery Pkwy

2025 Total
PM Peak

Intersection

Int Delay, s/veh 3.9

Movement	EBL	EBT	EBR	WBL	WBT	WBR	NBL	NBT	NBR	SBL	SBT	SBR
Lane Configurations	↖	↗		↖	↗			↕			↕	
Traffic Vol, veh/h	27	72	48	23	62	13	44	0	23	8	0	15
Future Vol, veh/h	27	72	48	23	62	13	44	0	23	8	0	15
Conflicting Peds, #/hr	0	0	0	0	0	0	0	0	0	0	0	0
Sign Control	Free	Free	Free	Free	Free	Free	Stop	Stop	Stop	Stop	Stop	Stop
RT Channelized	-	-	None	-	-	None	-	-	None	-	-	None
Storage Length	150	-	-	150	-	-	-	-	-	-	-	-
Veh in Median Storage, #	-	0	-	-	0	-	-	0	-	-	0	-
Grade, %	-	0	-	-	0	-	-	0	-	-	0	-
Peak Hour Factor	92	92	92	92	92	92	92	92	92	92	92	92
Heavy Vehicles, %	2	2	2	2	2	2	2	2	2	2	2	2
Mvmt Flow	29	78	52	25	67	14	48	0	25	9	0	16

Major/Minor	Major1			Major2			Minor1			Minor2		
Conflicting Flow All	81	0	0	130	0	0	294	293	104	299	312	74
Stage 1	-	-	-	-	-	-	162	162	-	124	124	-
Stage 2	-	-	-	-	-	-	132	131	-	175	188	-
Critical Hdwy	4.12	-	-	4.12	-	-	7.12	6.52	6.22	7.12	6.52	6.22
Critical Hdwy Stg 1	-	-	-	-	-	-	6.12	5.52	-	6.12	5.52	-
Critical Hdwy Stg 2	-	-	-	-	-	-	6.12	5.52	-	6.12	5.52	-
Follow-up Hdwy	2.218	-	-	2.218	-	-	3.518	4.018	3.318	3.518	4.018	3.318
Pot Cap-1 Maneuver	1517	-	-	1455	-	-	658	618	951	653	603	988
Stage 1	-	-	-	-	-	-	840	764	-	880	793	-
Stage 2	-	-	-	-	-	-	871	788	-	827	745	-
Platoon blocked, %	-	-	-	-	-	-	-	-	-	-	-	-
Mov Cap-1 Maneuver	1517	-	-	1455	-	-	629	596	951	618	581	988
Mov Cap-2 Maneuver	-	-	-	-	-	-	629	596	-	618	581	-
Stage 1	-	-	-	-	-	-	824	749	-	863	780	-
Stage 2	-	-	-	-	-	-	842	775	-	790	731	-

Approach	EB			WB			NB			SB		
HCM Control Delay, s	1.4			1.8			10.6			9.5		
HCM LOS							B			A		

Minor Lane/Major Mvmt	NBLn1	EBL	EBT	EBR	WBL	WBT	WBR	SBLn1
Capacity (veh/h)	712	1517	-	-	1455	-	-	818
HCM Lane V/C Ratio	0.102	0.019	-	-	0.017	-	-	0.031
HCM Control Delay (s)	10.6	7.4	-	-	7.5	-	-	9.5
HCM Lane LOS	B	A	-	-	A	-	-	A
HCM 95th %tile Q(veh)	0.3	0.1	-	-	0.1	-	-	0.1

HCM 6th TWSC
43: Three-Quarter Access & Pinery Pkwy

2025 Total
PM Peak

Intersection												
Int Delay, s/veh	1											
Movement	EBL	EBT	EBR	WBL	WBT	WBR	NBL	NBT	NBR	SBL	SBT	SBR
Lane Configurations	↖	↑	↗	↖	↗				↗			↗
Traffic Vol, veh/h	3	121	140	9	244	5	0	0	49	0	0	2
Future Vol, veh/h	3	121	140	9	244	5	0	0	49	0	0	2
Conflicting Peds, #/hr	0	0	0	0	0	0	0	0	0	0	0	0
Sign Control	Free	Free	Free	Free	Free	Free	Stop	Stop	Stop	Stop	Stop	Stop
RT Channelized	-	-	None	-	-	None	-	-	None	-	-	None
Storage Length	150	-	0	150	-	-	-	-	0	-	-	0
Veh in Median Storage, #	-	0	-	-	0	-	-	0	-	-	0	-
Grade, %	-	0	-	-	0	-	-	0	-	-	0	-
Peak Hour Factor	92	92	92	92	92	92	92	92	92	92	92	92
Heavy Vehicles, %	2	2	2	2	2	2	2	2	2	2	2	2
Mvmt Flow	3	132	152	10	265	5	0	0	53	0	0	2

Major/Minor	Major1			Major2			Minor1			Minor2		
Conflicting Flow All	270	0	0	284	0	0	-	-	132	-	-	268
Stage 1	-	-	-	-	-	-	-	-	-	-	-	-
Stage 2	-	-	-	-	-	-	-	-	-	-	-	-
Critical Hdwy	4.12	-	-	4.12	-	-	-	-	6.22	-	-	6.22
Critical Hdwy Stg 1	-	-	-	-	-	-	-	-	-	-	-	-
Critical Hdwy Stg 2	-	-	-	-	-	-	-	-	-	-	-	-
Follow-up Hdwy	2.218	-	-	2.218	-	-	-	-	3.318	-	-	3.318
Pot Cap-1 Maneuver	1293	-	-	1278	-	-	0	0	917	0	0	771
Stage 1	-	-	-	-	-	-	0	0	-	0	0	-
Stage 2	-	-	-	-	-	-	0	0	-	0	0	-
Platoon blocked, %	-	-	-	-	-	-	-	-	-	-	-	-
Mov Cap-1 Maneuver	1293	-	-	1278	-	-	-	-	917	-	-	771
Mov Cap-2 Maneuver	-	-	-	-	-	-	-	-	-	-	-	-
Stage 1	-	-	-	-	-	-	-	-	-	-	-	-
Stage 2	-	-	-	-	-	-	-	-	-	-	-	-

Approach	EB			WB			NB			SB		
HCM Control Delay, s	0.1			0.3			9.2			9.7		
HCM LOS							A			A		

Minor Lane/Major Mvmt	NBLn1	EBL	EBT	EBR	WBL	WBT	WBR	SBLn1
Capacity (veh/h)	917	1293	-	-	1278	-	-	771
HCM Lane V/C Ratio	0.058	0.003	-	-	0.008	-	-	0.003
HCM Control Delay (s)	9.2	7.8	-	-	7.8	-	-	9.7
HCM Lane LOS	A	A	-	-	A	-	-	A
HCM 95th %tile Q(veh)	0.2	0	-	-	0	-	-	0

HCM 6th TWSC
44: PA 46/PA 47 & Pinery Pkwy

2025 Total
PM Peak

Intersection

Int Delay, s/veh 5.7

Movement	EBL	EBT	EBR	WBL	WBT	WBR	NBL	NBT	NBR	SBL	SBT	SBR
Lane Configurations	↖	↗		↖	↗			↕			↕	
Traffic Vol, veh/h	11	137	22	44	109	33	139	5	12	21	0	10
Future Vol, veh/h	11	137	22	44	109	33	139	5	12	21	0	10
Conflicting Peds, #/hr	0	0	0	0	0	0	0	0	0	0	0	0
Sign Control	Free	Free	Free	Free	Free	Free	Stop	Stop	Stop	Stop	Stop	Stop
RT Channelized	-	-	None	-	-	None	-	-	None	-	-	None
Storage Length	0	-	-	0	-	-	-	-	-	-	-	-
Veh in Median Storage, #	-	0	-	-	0	-	-	0	-	-	0	-
Grade, %	-	0	-	-	0	-	-	0	-	-	0	-
Peak Hour Factor	92	92	92	92	92	92	92	92	92	92	92	92
Heavy Vehicles, %	2	2	2	2	2	2	2	2	2	2	2	2
Mvmt Flow	12	149	24	48	118	36	151	5	13	23	0	11

Major/Minor	Major1	Major2	Minor1	Minor2
Conflicting Flow All	154	0	0	173
Stage 1	-	-	-	-
Stage 2	-	-	-	-
Critical Hdwy	4.12	-	-	4.12
Critical Hdwy Stg 1	-	-	-	-
Critical Hdwy Stg 2	-	-	-	-
Follow-up Hdwy	2.218	-	-	2.218
Pot Cap-1 Maneuver	1426	-	-	1404
Stage 1	-	-	-	-
Stage 2	-	-	-	-
Platoon blocked, %	-	-	-	-
Mov Cap-1 Maneuver	1426	-	-	1404
Mov Cap-2 Maneuver	-	-	-	-
Stage 1	-	-	-	-
Stage 2	-	-	-	-

Approach	EB	WB	NB	SB
HCM Control Delay, s	0.5	1.8	14.9	11.4
HCM LOS			B	B

Minor Lane/Major Mvmt	NBLn1	EBL	EBT	EBR	WBL	WBT	WBR	SBLn1
Capacity (veh/h)	533	1426	-	-	1404	-	-	594
HCM Lane V/C Ratio	0.318	0.008	-	-	0.034	-	-	0.057
HCM Control Delay (s)	14.9	7.5	-	-	7.7	-	-	11.4
HCM Lane LOS	B	A	-	-	A	-	-	B
HCM 95th %tile Q(veh)	1.4	0	-	-	0.1	-	-	0.2

HCM 6th TWSC
 48: Bayou Gulch Rd & PA-36&37/PA 34&35

2025 Total
 PM Peak

Intersection												
Int Delay, s/veh	2.8											
Movement	EBL	EBT	EBR	WBL	WBT	WBR	NBL	NBT	NBR	SBL	SBT	SBR
Lane Configurations	↖	↗		↖	↗	↖	↖	↗	↖	↖	↗	↖
Traffic Vol, veh/h	27	0	10	6	0	46	14	136	9	79	235	51
Future Vol, veh/h	27	0	10	6	0	46	14	136	9	79	235	51
Conflicting Peds, #/hr	0	0	0	0	0	0	0	0	0	0	0	0
Sign Control	Stop	Stop	Stop	Stop	Stop	Stop	Free	Free	Free	Free	Free	Free
RT Channelized	-	-	None	-	-	None	-	-	None	-	-	None
Storage Length	0	-	-	0	-	150	150	-	150	150	-	150
Veh in Median Storage, #	-	0	-	-	0	-	-	0	-	-	0	-
Grade, %	-	0	-	-	0	-	-	0	-	-	0	-
Peak Hour Factor	92	92	92	92	92	92	92	92	92	92	92	92
Heavy Vehicles, %	2	2	2	2	2	2	2	2	2	2	2	2
Mvmt Flow	29	0	11	7	0	50	15	148	10	86	255	55

Major/Minor	Minor2		Minor1		Major1			Major2				
Conflicting Flow All	531	615	128	478	660	74	310	0	0	158	0	0
Stage 1	427	427	-	178	178	-	-	-	-	-	-	-
Stage 2	104	188	-	300	482	-	-	-	-	-	-	-
Critical Hdwy	7.54	6.54	6.94	7.54	6.54	6.94	4.14	-	-	4.14	-	-
Critical Hdwy Stg 1	6.54	5.54	-	6.54	5.54	-	-	-	-	-	-	-
Critical Hdwy Stg 2	6.54	5.54	-	6.54	5.54	-	-	-	-	-	-	-
Follow-up Hdwy	3.52	4.02	3.32	3.52	4.02	3.32	2.22	-	-	2.22	-	-
Pot Cap-1 Maneuver	431	405	898	470	382	973	1247	-	-	1419	-	-
Stage 1	576	584	-	806	751	-	-	-	-	-	-	-
Stage 2	890	743	-	684	552	-	-	-	-	-	-	-
Platoon blocked, %								-	-	-	-	-
Mov Cap-1 Maneuver	386	376	898	439	354	973	1247	-	-	1419	-	-
Mov Cap-2 Maneuver	386	376	-	439	354	-	-	-	-	-	-	-
Stage 1	569	548	-	796	742	-	-	-	-	-	-	-
Stage 2	834	734	-	635	518	-	-	-	-	-	-	-

Approach	EB		WB		NB			SB		
HCM Control Delay, s	13.5		9.4		0.7			1.7		
HCM LOS	B		A							

Minor Lane/Major Mvmt	NBL	NBT	NBR	EBLn1	EBLn2	WBLn1	WBLn2	WBLn3	SBL	SBT	SBR
Capacity (veh/h)	1247	-	-	386	898	439	-	973	1419	-	-
HCM Lane V/C Ratio	0.012	-	-	0.076	0.012	0.015	-	0.051	0.061	-	-
HCM Control Delay (s)	7.9	-	-	15.1	9.1	13.3	0	8.9	7.7	-	-
HCM Lane LOS	A	-	-	C	A	B	A	A	A	-	-
HCM 95th %tile Q(veh)	0	-	-	0.2	0	0	-	0.2	0.2	-	-

HCM 6th Signalized Intersection Summary
 2: Crowfoot Valley Rd/Motsenbocker Rd & Stroh Rd

2037 Background Traffic
 AM Peak Hour

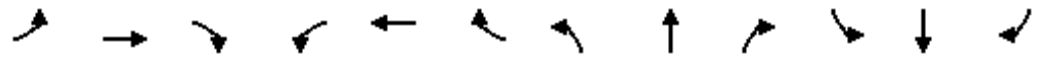

Movement	EBL	EBT	EBR	WBL	WBT	WBR	NBL	NBT	NBR	SBL	SBT	SBR
Lane Configurations												
Traffic Volume (veh/h)	60	380	125	600	215	250	75	281	815	100	192	25
Future Volume (veh/h)	60	380	125	600	215	250	75	281	815	100	192	25
Initial Q (Qb), veh	0	0	0	0	0	0	0	0	0	0	0	0
Ped-Bike Adj(A_pbT)	1.00		1.00	1.00		1.00	1.00		1.00	1.00		1.00
Parking Bus, Adj	1.00	1.00	1.00	1.00	1.00	1.00	1.00	1.00	1.00	1.00	1.00	1.00
Work Zone On Approach		No			No			No			No	
Adj Sat Flow, veh/h/ln	1870	1870	1870	1870	1870	1870	1870	1870	1870	1870	1870	1870
Adj Flow Rate, veh/h	63	400	132	632	226	263	79	296	858	105	202	26
Peak Hour Factor	0.95	0.95	0.95	0.95	0.95	0.95	0.95	0.95	0.95	0.95	0.95	0.95
Percent Heavy Veh, %	2	2	2	2	2	2	2	2	2	2	2	2
Cap, veh/h	286	545	318	736	1129	504	162	1582	1043	350	1611	718
Arrive On Green	0.05	0.15	0.15	0.21	0.32	0.32	0.05	0.45	0.45	0.06	0.45	0.45
Sat Flow, veh/h	1781	3554	1585	3456	3554	1585	3456	3554	1585	1781	3554	1585
Grp Volume(v), veh/h	63	400	132	632	226	263	79	296	858	105	202	26
Grp Sat Flow(s),veh/h/ln	1781	1777	1585	1728	1777	1585	1728	1777	1585	1781	1777	1585
Q Serve(g_s), s	3.5	12.9	8.7	21.1	5.6	16.3	2.7	6.0	48.4	3.8	4.0	1.1
Cycle Q Clear(g_c), s	3.5	12.9	8.7	21.1	5.6	16.3	2.7	6.0	48.4	3.8	4.0	1.1
Prop In Lane	1.00		1.00	1.00		1.00	1.00		1.00	1.00		1.00
Lane Grp Cap(c), veh/h	286	545	318	736	1129	504	162	1582	1043	350	1611	718
V/C Ratio(X)	0.22	0.73	0.42	0.86	0.20	0.52	0.49	0.19	0.82	0.30	0.13	0.04
Avail Cap(c_a), veh/h	318	918	484	893	1599	713	230	1582	1043	371	1611	718
HCM Platoon Ratio	1.00	1.00	1.00	1.00	1.00	1.00	1.00	1.00	1.00	1.00	1.00	1.00
Upstream Filter(I)	1.00	1.00	1.00	1.00	1.00	1.00	1.00	1.00	1.00	1.00	1.00	1.00
Uniform Delay (d), s/veh	39.6	48.5	41.9	45.5	29.8	33.5	55.8	20.1	15.3	16.1	19.0	18.2
Incr Delay (d2), s/veh	0.4	1.9	0.9	7.2	0.1	0.8	2.2	0.3	7.3	0.5	0.2	0.1
Initial Q Delay(d3),s/veh	0.0	0.0	0.0	0.0	0.0	0.0	0.0	0.0	0.0	0.0	0.0	0.0
%ile BackOfQ(50%),veh/ln	1.5	5.8	3.4	9.6	2.4	6.2	1.2	2.5	17.2	1.6	1.7	0.4
Unsig. Movement Delay, s/veh												
LnGrp Delay(d),s/veh	40.0	50.4	42.7	52.7	29.9	34.3	58.0	20.4	22.6	16.6	19.2	18.3
LnGrp LOS	D	D	D	D	C	C	E	C	C	B	B	B
Approach Vol, veh/h		595			1121			1233			333	
Approach Delay, s/veh		47.6			43.8			24.3			18.3	
Approach LOS		D			D			C			B	
Timer - Assigned Phs	1	2	3	4	5	6	7	8				
Phs Duration (G+Y+Rc), s	10.6	57.4	29.6	22.4	9.6	58.4	9.8	42.1				
Change Period (Y+Rc), s	5.0	5.0	5.0	5.0	5.0	5.0	5.0	5.0				
Max Green Setting (Gmax), s	7.0	33.0	30.0	30.0	7.0	33.0	7.0	53.0				
Max Q Clear Time (g_c+I1), s	5.8	50.4	23.1	14.9	4.7	6.0	5.5	18.3				
Green Ext Time (p_c), s	0.0	0.0	1.4	2.5	0.0	1.3	0.0	2.3				

Intersection Summary

HCM 6th Ctrl Delay	34.6
HCM 6th LOS	C

HCM 6th Signalized Intersection Summary
 3: Crowfoot Valley Rd & Chambers Rd/Bayou Gulch Rd

2037 Background Traffic
 AM Peak Hour



Movement	EBL	EBT	EBR	WBL	WBT	WBR	NBL	NBT	NBR	SBL	SBT	SBR
Lane Configurations	↔↔	↑↑	↗	↔↔	↑↑	↗	↔↔	↑↑	↗	↔↔	↑↑	↗
Traffic Volume (veh/h)	110	693	782	96	828	386	935	765	83	352	455	60
Future Volume (veh/h)	110	693	782	96	828	386	935	765	83	352	455	60
Initial Q (Qb), veh	0	0	0	0	0	0	0	0	0	0	0	0
Ped-Bike Adj(A_pbT)	1.00		1.00	1.00		1.00	1.00		1.00	1.00		1.00
Parking Bus, Adj	1.00	1.00	1.00	1.00	1.00	1.00	1.00	1.00	1.00	1.00	1.00	1.00
Work Zone On Approach		No			No			No			No	
Adj Sat Flow, veh/h/ln	1870	1870	1870	1870	1870	1870	1870	1870	1870	1870	1870	1870
Adj Flow Rate, veh/h	116	729	823	101	872	0	984	805	87	371	479	63
Peak Hour Factor	0.95	0.95	0.95	0.95	0.95	0.95	0.95	0.95	0.95	0.95	0.95	0.95
Percent Heavy Veh, %	2	2	2	2	2	2	2	2	2	2	2	2
Cap, veh/h	199	1066	949	189	1056		1032	1356	605	450	758	338
Arrive On Green	0.06	0.30	0.30	0.02	0.10	0.00	0.50	0.64	0.64	0.13	0.21	0.21
Sat Flow, veh/h	3456	3554	1585	3456	3554	1585	3456	3554	1585	3456	3554	1585
Grp Volume(v), veh/h	116	729	823	101	872	0	984	805	87	371	479	63
Grp Sat Flow(s),veh/h/ln	1728	1777	1585	1728	1777	1585	1728	1777	1585	1728	1777	1585
Q Serve(g_s), s	3.9	21.7	36.0	3.5	28.9	0.0	32.7	15.9	2.6	12.6	14.7	3.9
Cycle Q Clear(g_c), s	3.9	21.7	36.0	3.5	28.9	0.0	32.7	15.9	2.6	12.6	14.7	3.9
Prop In Lane	1.00		1.00	1.00		1.00	1.00		1.00	1.00		1.00
Lane Grp Cap(c), veh/h	199	1066	949	189	1056		1032	1356	605	450	758	338
V/C Ratio(X)	0.58	0.68	0.87	0.53	0.83		0.95	0.59	0.14	0.82	0.63	0.19
Avail Cap(c_a), veh/h	317	1066	949	317	1066		1037	1356	605	461	758	338
HCM Platoon Ratio	1.00	1.00	1.00	0.33	0.33	0.33	1.67	1.67	1.67	1.00	1.00	1.00
Upstream Filter(I)	1.00	1.00	1.00	1.00	1.00	0.00	0.71	0.71	0.71	1.00	1.00	1.00
Uniform Delay (d), s/veh	55.1	37.0	20.1	57.4	51.1	0.0	29.3	16.3	13.9	50.9	42.9	38.7
Incr Delay (d2), s/veh	2.7	1.8	8.6	2.3	5.4	0.0	14.0	1.4	0.4	11.4	4.0	1.2
Initial Q Delay(d3),s/veh	0.0	0.0	0.0	0.0	0.0	0.0	0.0	0.0	0.0	0.0	0.0	0.0
%ile BackOfQ(50%),veh/ln	1.8	9.6	20.2	1.6	14.6	0.0	13.2	5.1	1.0	6.1	6.9	1.6
Unsig. Movement Delay, s/veh												
LnGrp Delay(d),s/veh	57.8	38.8	28.7	59.7	56.5	0.0	43.3	17.7	14.3	62.3	46.9	39.9
LnGrp LOS	E	D	C	E	E		D	B	B	E	D	D
Approach Vol, veh/h		1668			973	A		1876			913	
Approach Delay, s/veh		35.1			56.8			31.0			52.7	
Approach LOS		D			E			C			D	
Timer - Assigned Phs	1	2	3	4	5	6	7	8				
Phs Duration (G+Y+Rc), s	19.6	49.8	10.6	40.0	39.8	29.6	10.9	39.7				
Change Period (Y+Rc), s	5.0	5.0	5.0	5.0	5.0	5.0	5.0	5.0				
Max Green Setting (Gmax), s	15.0	40.0	10.0	35.0	35.0	20.0	10.0	35.0				
Max Q Clear Time (g_c+M), s	14.6	17.9	5.5	38.0	34.7	16.7	5.9	31.9				
Green Ext Time (p_c), s	0.1	6.2	0.1	0.0	0.2	1.1	0.1	1.7				

Intersection Summary

HCM 6th Ctrl Delay	40.5
HCM 6th LOS	D

Notes

Unsignalized Delay for [WBR] is excluded from calculations of the approach delay and intersection delay.

HCM 6th Signalized Intersection Summary
 4: Crowfoot Valley Rd & Pinery Pkwy

2037 Background Traffic
 AM Peak Hour



Movement	WBL	WBR	NBT	NBR	SBL	SBT
Lane Configurations						
Traffic Volume (veh/h)	73	16	1808	100	11	1426
Future Volume (veh/h)	73	16	1808	100	11	1426
Initial Q (Qb), veh	0	0	0	0	0	0
Ped-Bike Adj(A_pbT)	1.00	1.00		1.00	1.00	
Parking Bus, Adj	1.00	1.00	1.00	1.00	1.00	1.00
Work Zone On Approach	No		No		No	
Adj Sat Flow, veh/h/ln	1870	1870	1870	1870	1870	1870
Adj Flow Rate, veh/h	77	0	1903	105	12	1501
Peak Hour Factor	0.95	0.95	0.95	0.95	0.95	0.95
Percent Heavy Veh, %	2	2	2	2	2	2
Cap, veh/h	99		2862	1277	209	3059
Arrive On Green	0.06	0.00	0.81	0.81	0.03	1.00
Sat Flow, veh/h	1781	1585	3647	1585	1781	3647
Grp Volume(v), veh/h	77	0	1903	105	12	1501
Grp Sat Flow(s),veh/h/ln	1781	1585	1777	1585	1781	1777
Q Serve(g_s), s	5.1	0.0	26.9	1.7	0.1	0.0
Cycle Q Clear(g_c), s	5.1	0.0	26.9	1.7	0.1	0.0
Prop In Lane	1.00	1.00		1.00	1.00	
Lane Grp Cap(c), veh/h	99		2862	1277	209	3059
V/C Ratio(X)	0.77		0.66	0.08	0.06	0.49
Avail Cap(c_a), veh/h	371		2862	1277	288	3059
HCM Platoon Ratio	1.00	1.00	1.00	1.00	2.00	2.00
Upstream Filter(I)	1.00	0.00	1.00	1.00	0.59	0.59
Uniform Delay (d), s/veh	55.9	0.0	4.9	2.4	5.2	0.0
Incr Delay (d2), s/veh	12.0	0.0	1.2	0.1	0.1	0.3
Initial Q Delay(d3),s/veh	0.0	0.0	0.0	0.0	0.0	0.0
%ile BackOfQ(50%),veh/ln	2.6	0.0	7.9	0.5	0.1	0.1
Unsig. Movement Delay, s/veh						
LnGrp Delay(d),s/veh	67.9	0.0	6.1	2.6	5.3	0.3
LnGrp LOS	E		A	A	A	A
Approach Vol, veh/h	77	A	2008			1513
Approach Delay, s/veh	67.9		5.9			0.4
Approach LOS	E		A			A
Timer - Assigned Phs	1	2			6	8
Phs Duration (G+Y+Rc), s	66.6				108.3	11.7
Change Period (Y+Rc), s	5.0	5.0			5.0	5.0
Max Green Setting (Gmax), s	73.0				85.0	25.0
Max Q Clear Time (g_c+I), s	28.9				2.0	7.1
Green Ext Time (p_c), s	0.0	26.2			20.0	0.1

Intersection Summary

HCM 6th Ctrl Delay		4.9				
HCM 6th LOS			A			

Notes

Unsignalized Delay for [WBR] is excluded from calculations of the approach delay and intersection delay.

HCM 6th Signalized Intersection Summary
5: Crowfoot Valley Rd & Pradera Pkwy

2037 Background Traffic
AM Peak Hour



Movement	WBL	WBR	NBT	NBR	SBL	SBT
Lane Configurations						
Traffic Volume (veh/h)	157	117	1714	64	20	1443
Future Volume (veh/h)	157	117	1714	64	20	1443
Initial Q (Qb), veh	0	0	0	0	0	0
Ped-Bike Adj(A_pbT)	1.00	1.00		1.00	1.00	
Parking Bus, Adj	1.00	1.00	1.00	1.00	1.00	1.00
Work Zone On Approach	No		No		No	
Adj Sat Flow, veh/h/ln	1870	1870	1870	1870	1870	1870
Adj Flow Rate, veh/h	165	123	1804	67	21	1519
Peak Hour Factor	0.95	0.95	0.95	0.95	0.95	0.95
Percent Heavy Veh, %	2	2	2	2	2	2
Cap, veh/h	201	179	2634	1175	213	2857
Arrive On Green	0.11	0.11	0.74	0.74	0.02	0.80
Sat Flow, veh/h	1781	1585	3647	1585	1781	3647
Grp Volume(v), veh/h	165	123	1804	67	21	1519
Grp Sat Flow(s),veh/h/ln	1781	1585	1777	1585	1781	1777
Q Serve(g_s), s	10.9	9.0	32.0	1.4	0.3	17.6
Cycle Q Clear(g_c), s	10.9	9.0	32.0	1.4	0.3	17.6
Prop In Lane	1.00	1.00		1.00	1.00	
Lane Grp Cap(c), veh/h	201	179	2634	1175	213	2857
V/C Ratio(X)	0.82	0.69	0.68	0.06	0.10	0.53
Avail Cap(c_a), veh/h	371	330	2634	1175	280	2857
HCM Platoon Ratio	1.00	1.00	1.00	1.00	1.00	1.00
Upstream Filter(I)	1.00	1.00	1.00	1.00	1.00	1.00
Uniform Delay (d), s/veh	52.1	51.2	8.2	4.2	8.2	4.0
Incr Delay (d2), s/veh	8.1	4.6	1.5	0.1	0.2	0.7
Initial Q Delay(d3),s/veh	0.0	0.0	0.0	0.0	0.0	0.0
%ile BackOfQ(50%),veh/ln	5.2	3.7	9.4	0.4	0.1	3.9
Unsig. Movement Delay, s/veh						
LnGrp Delay(d),s/veh	60.1	55.9	9.6	4.3	8.4	4.7
LnGrp LOS	E	E	A	A	A	A
Approach Vol, veh/h	288		1871			1540
Approach Delay, s/veh	58.3		9.4			4.8
Approach LOS	E		A			A
Timer - Assigned Phs	1	2			6	8
Phs Duration (G+Y+Rc), s	7.5	94.0			101.5	18.5
Change Period (Y+Rc), s	5.0	5.0			5.0	5.0
Max Green Setting (Gmax), s	73.0				85.0	25.0
Max Q Clear Time (g_c+1/2), s	34.0				19.6	12.9
Green Ext Time (p_c), s	0.0	19.2			15.9	0.7

Intersection Summary

HCM 6th Ctrl Delay		11.3				
HCM 6th LOS			B			

HCM 6th Signalized Intersection Summary
6: Parker Rd & Stroh Rd

2037 Background Traffic
AM Peak Hour



Movement	EBL	EBT	EBR	WBL	WBT	WBR	NBL	NBT	NBR	SBL	SBT	SBR
Lane Configurations	↖↗	↑	↖	↖	↖		↖↗	↑↑↑		↖	↑↑↑	↖
Traffic Volume (veh/h)	0	0	0	0	0	0	0	13	0	0	16	0
Future Volume (veh/h)	0	0	0	0	0	0	0	13	0	0	16	0
Initial Q (Qb), veh	0	0	0	0	0	0	0	0	0	0	0	0
Ped-Bike Adj(A_pbT)	1.00		1.00	1.00		1.00	1.00		1.00	1.00		1.00
Parking Bus, Adj	1.00	1.00	1.00	1.00	1.00	1.00	1.00	1.00	1.00	1.00	1.00	1.00
Work Zone On Approach		No			No			No			No	
Adj Sat Flow, veh/h/ln	1870	1870	1870	1870	1870	1870	1870	1870	1870	1870	1870	1870
Adj Flow Rate, veh/h	0	0	0	0	0	0	0	14	0	0	17	0
Peak Hour Factor	0.95	0.95	0.95	0.95	0.95	0.95	0.95	0.95	0.95	0.95	0.95	0.95
Percent Heavy Veh, %	2	2	2	2	2	2	2	2	2	2	2	2
Cap, veh/h	3	2		1	2	0	3	4808	0	1	4808	
Arrive On Green	0.00	0.00	0.00	0.00	0.00	0.00	0.00	0.94	0.00	0.00	0.94	0.00
Sat Flow, veh/h	3456	1870	1585	1781	1870	0	3456	5274	0	1781	5106	1585
Grp Volume(v), veh/h	0	0	0	0	0	0	0	14	0	0	17	0
Grp Sat Flow(s),veh/h/ln	1728	1870	1585	1781	1870	0	1728	1702	0	1781	1702	1585
Q Serve(g_s), s	0.0	0.0	0.0	0.0	0.0	0.0	0.0	0.0	0.0	0.0	0.0	0.0
Cycle Q Clear(g_c), s	0.0	0.0	0.0	0.0	0.0	0.0	0.0	0.0	0.0	0.0	0.0	0.0
Prop In Lane	1.00		1.00	1.00		0.00	1.00		0.00	1.00		1.00
Lane Grp Cap(c), veh/h	3	2		1	2	0	3	4808	0	1	4808	
V/C Ratio(X)	0.00	0.00		0.00	0.00	0.00	0.00	0.00	0.00	0.00	0.00	0.00
Avail Cap(c_a), veh/h	720	390		74	78	0	288	4808	0	74	4808	
HCM Platoon Ratio	1.00	1.00	1.00	1.00	1.00	1.00	1.00	1.00	1.00	1.00	1.00	1.00
Upstream Filter(I)	0.00	0.00	0.00	0.00	0.00	0.00	0.00	0.17	0.00	0.00	1.00	0.00
Uniform Delay (d), s/veh	0.0	0.0	0.0	0.0	0.0	0.0	0.0	0.2	0.0	0.0	0.2	0.0
Incr Delay (d2), s/veh	0.0	0.0	0.0	0.0	0.0	0.0	0.0	0.0	0.0	0.0	0.0	0.0
Initial Q Delay(d3),s/veh	0.0	0.0	0.0	0.0	0.0	0.0	0.0	0.0	0.0	0.0	0.0	0.0
%ile BackOfQ(50%),veh/ln	0.0	0.0	0.0	0.0	0.0	0.0	0.0	0.0	0.0	0.0	0.0	0.0
Unsig. Movement Delay, s/veh												
LnGrp Delay(d),s/veh	0.0	0.0	0.0	0.0	0.0	0.0	0.0	0.2	0.0	0.0	0.2	0.0
LnGrp LOS	A	A		A	A	A	A	A	A	A	A	A
Approach Vol, veh/h		0	A		0			14			17	A
Approach Delay, s/veh		0.0			0.0			0.2			0.2	
Approach LOS								A			A	
Timer - Assigned Phs	1	2		4	5	6		8				
Phs Duration (G+Y+Rc), s	0.0	120.0		0.0	0.0	120.0		0.0			0.0	
Change Period (Y+Rc), s	5.0	7.0		5.0	5.0	7.0		5.0			5.0	
Max Green Setting (Gmax), s	5.0	63.0		25.0	10.0	58.0		5.0			5.0	
Max Q Clear Time (g_c+1), s	10.0	2.0		0.0	0.0	2.0		0.0			0.0	
Green Ext Time (p_c), s	0.0	0.1		0.0	0.0	0.1		0.0			0.0	

Intersection Summary

HCM 6th Ctrl Delay	0.2
HCM 6th LOS	A

Notes

Unsignalized Delay for [EBR, SBR] is excluded from calculations of the approach delay and intersection delay.

HCM 6th Signalized Intersection Summary
7: Parker Rd & Pinery Pkwy

2037 Background Traffic
AM Peak Hour



Movement	EBL	EBT	EBR	WBL	WBT	WBR	NBL	NBT	NBR	SBL	SBT	SBR
Lane Configurations	↔↔	↑	↗	↖	↖		↖↑↑↑			↖↖	↑↑↑	↗
Traffic Volume (veh/h)	53	30	118	75	125	325	149	2180	70	90	800	41
Future Volume (veh/h)	53	30	118	75	125	325	149	2180	70	90	800	41
Initial Q (Qb), veh	0	0	0	0	0	0	0	0	0	0	0	0
Ped-Bike Adj(A_pbT)	1.00		1.00	1.00		1.00	1.00		1.00	1.00		1.00
Parking Bus, Adj	1.00	1.00	1.00	1.00	1.00	1.00	1.00	1.00	1.00	1.00	1.00	1.00
Work Zone On Approach		No			No			No			No	
Adj Sat Flow, veh/h/ln	1870	1870	1870	1870	1870	1870	1870	1870	1870	1870	1870	1870
Adj Flow Rate, veh/h	56	32	0	79	132	342	157	2295	74	95	842	0
Peak Hour Factor	0.95	0.95	0.95	0.95	0.95	0.95	0.95	0.95	0.95	0.95	0.95	0.95
Percent Heavy Veh, %	2	2	2	2	2	2	2	2	2	2	2	2
Cap, veh/h	151	390		428	104	269	198	2742	88	174	2444	
Arrive On Green	0.04	0.21	0.00	0.06	0.22	0.22	0.11	0.54	0.53	0.05	0.48	0.00
Sat Flow, veh/h	3456	1870	1585	1781	461	1194	1781	5082	163	3456	5106	1585
Grp Volume(v), veh/h	56	32	0	79	0	474	157	1534	835	95	842	0
Grp Sat Flow(s),veh/h/ln	1728	1870	1585	1781	0	1655	1781	1702	1841	1728	1702	1585
Q Serve(g_s), s	1.9	1.7	0.0	4.1	0.0	27.0	10.3	45.3	45.9	3.2	12.4	0.0
Cycle Q Clear(g_c), s	1.9	1.7	0.0	4.1	0.0	27.0	10.3	45.3	45.9	3.2	12.4	0.0
Prop In Lane	1.00		1.00	1.00		0.72	1.00		0.09	1.00		1.00
Lane Grp Cap(c), veh/h	151	390		428	0	372	198	1836	993	174	2444	
V/C Ratio(X)	0.37	0.08		0.18	0.00	1.27	0.79	0.84	0.84	0.55	0.34	
Avail Cap(c_a), veh/h	317	405		499	0	372	238	1836	993	230	2444	
HCM Platoon Ratio	1.00	1.00	1.00	1.00	1.00	1.00	1.00	1.00	1.00	1.00	1.00	1.00
Upstream Filter(I)	1.00	1.00	0.00	1.00	0.00	1.00	1.00	1.00	1.00	1.00	1.00	0.00
Uniform Delay (d), s/veh	55.8	38.2	0.0	34.0	0.0	46.9	52.0	23.2	23.3	55.6	19.5	0.0
Incr Delay (d2), s/veh	1.5	0.1	0.0	0.2	0.0	142.2	14.2	4.7	8.5	2.7	0.4	0.0
Initial Q Delay(d3),s/veh	0.0	0.0	0.0	0.0	0.0	0.0	0.0	0.0	0.0	0.0	0.0	0.0
%ile BackOfQ(50%),veh/ln	0.9	0.8	0.0	1.8	0.0	25.9	5.2	17.0	19.7	1.4	4.6	0.0
Unsig. Movement Delay, s/veh												
LnGrp Delay(d),s/veh	57.3	38.3	0.0	34.2	0.0	189.0	66.2	27.8	31.9	58.3	19.9	0.0
LnGrp LOS	E	D		C	A	F	E	C	C	E	B	
Approach Vol, veh/h		88	A		553		2526			937	A	
Approach Delay, s/veh		50.4			166.9		31.6			23.8		
Approach LOS		D			F		C			C		
Timer - Assigned Phs	1	2	3	4	5	6	7	8				
Phs Duration (G+Y+Rc), s	10.0	70.7	10.2	29.0	17.3	63.4	9.2	30.0				
Change Period (Y+Rc), s	5.0	7.0	4.5	5.0	5.0	7.0	5.0	5.0				
Max Green Setting (Gmax), s	56.0	10.5	25.0	15.0	48.0	10.0	25.0					
Max Q Clear Time (g_c+1), s	47.9	6.1	3.7	12.3	14.4	3.9	29.0					
Green Ext Time (p_c), s	0.0	7.0	0.1	0.1	0.1	5.6	0.0	0.0				

Intersection Summary

HCM 6th Ctrl Delay	48.4
HCM 6th LOS	D

Notes

Unsignalized Delay for [EBR, SBR] is excluded from calculations of the approach delay and intersection delay.

HCM 6th Signalized Intersection Summary
 8: Bayou Gulch Rd & Pinery Pkwy

2037 Background Traffic
 AM Peak Hour



Movement	EBL	EBT	EBR	WBL	WBT	WBR	NBL	NBT	NBR	SBL	SBT	SBR
Lane Configurations												
Traffic Volume (veh/h)	77	21	13	7	31	363	23	828	22	315	725	35
Future Volume (veh/h)	77	21	13	7	31	363	23	828	22	315	725	35
Initial Q (Qb), veh	0	0	0	0	0	0	0	0	0	0	0	0
Ped-Bike Adj(A_pbT)	1.00		1.00	1.00		1.00	1.00		1.00	1.00		1.00
Parking Bus, Adj	1.00	1.00	1.00	1.00	1.00	1.00	1.00	1.00	1.00	1.00	1.00	1.00
Work Zone On Approach		No			No			No			No	
Adj Sat Flow, veh/h/ln	1870	1870	1870	1870	1870	1870	1870	1870	1870	1870	1870	1870
Adj Flow Rate, veh/h	81	22	14	7	33	382	24	872	23	332	763	37
Peak Hour Factor	0.95	0.95	0.95	0.95	0.95	0.95	0.95	0.95	0.95	0.95	0.95	0.95
Percent Heavy Veh, %	2	2	2	2	2	2	2	2	2	2	2	2
Cap, veh/h	374	513	435	414	442	573	357	1599	713	434	1934	863
Arrive On Green	0.06	0.27	0.27	0.02	0.24	0.24	0.03	0.45	0.45	0.04	0.18	0.18
Sat Flow, veh/h	1781	1870	1585	1781	1870	1585	1781	3554	1585	3456	3554	1585
Grp Volume(v), veh/h	81	22	14	7	33	382	24	872	23	332	763	37
Grp Sat Flow(s),veh/h/ln	1781	1870	1585	1781	1870	1585	1781	1777	1585	1728	1777	1585
Q Serve(g_s), s	4.0	1.0	0.8	0.4	1.6	24.3	0.9	21.5	1.0	11.4	22.7	2.3
Cycle Q Clear(g_c), s	4.0	1.0	0.8	0.4	1.6	24.3	0.9	21.5	1.0	11.4	22.7	2.3
Prop In Lane	1.00		1.00	1.00		1.00	1.00		1.00	1.00		1.00
Lane Grp Cap(c), veh/h	374	513	435	414	442	573	357	1599	713	434	1934	863
V/C Ratio(X)	0.22	0.04	0.03	0.02	0.07	0.67	0.07	0.55	0.03	0.76	0.39	0.04
Avail Cap(c_a), veh/h	439	561	476	547	561	675	464	1599	713	605	1934	863
HCM Platoon Ratio	1.00	1.00	1.00	1.00	1.00	1.00	1.00	1.00	1.00	0.33	0.33	0.33
Upstream Filter(I)	1.00	1.00	1.00	1.00	1.00	1.00	1.00	1.00	1.00	1.00	1.00	1.00
Uniform Delay (d), s/veh	30.2	32.0	31.9	33.6	35.6	32.2	16.9	24.1	18.4	55.8	31.8	23.4
Incr Delay (d2), s/veh	0.3	0.0	0.0	0.0	0.1	2.0	0.1	1.3	0.1	3.8	0.6	0.1
Initial Q Delay(d3),s/veh	0.0	0.0	0.0	0.0	0.0	0.0	0.0	0.0	0.0	0.0	0.0	0.0
%ile BackOfQ(50%),veh/ln	1.7	0.5	0.3	0.2	0.8	9.3	0.4	9.2	0.4	5.5	11.0	0.8
Unsig. Movement Delay, s/veh												
LnGrp Delay(d),s/veh	30.5	32.0	31.9	33.6	35.7	34.2	17.0	25.4	18.5	59.6	32.4	23.5
LnGrp LOS	C	C	C	C	D	C	B	C	B	E	C	C
Approach Vol, veh/h		117			422			919			1132	
Approach Delay, s/veh		30.9			34.3			25.0			40.1	
Approach LOS		C			C			C			D	
Timer - Assigned Phs	1	2	3	4	5	6	7	8				
Phs Duration (G+Y+Rc), s	19.1	58.0	6.0	36.9	7.8	69.3	10.6	32.3				
Change Period (Y+Rc), s	5.0	5.0	5.0	5.0	5.0	5.0	5.0	5.0				
Max Green Setting (Gmax), s	20.0	35.0	10.0	35.0	10.0	45.0	10.0	35.0				
Max Q Clear Time (g_c+I), s	11.4	23.5	2.4	3.0	2.9	24.7	6.0	26.3				
Green Ext Time (p_c), s	0.7	4.7	0.0	0.1	0.0	5.5	0.0	1.0				

Intersection Summary

HCM 6th Ctrl Delay	33.4
HCM 6th LOS	C

Intersection

Int Delay, s/veh 0.6

Movement	EBT	EBR	WBL	WBT	NBL	NBR
Lane Configurations						
Traffic Vol, veh/h	349	9	6	384	17	12
Future Vol, veh/h	349	9	6	384	17	12
Conflicting Peds, #/hr	0	0	0	0	0	0
Sign Control	Free	Free	Free	Free	Stop	Stop
RT Channelized	-	None	-	None	-	None
Storage Length	-	-	0	-	0	-
Veh in Median Storage, #	0	-	-	0	0	-
Grade, %	0	-	-	0	0	-
Peak Hour Factor	95	95	95	95	95	95
Heavy Vehicles, %	2	2	2	2	2	2
Mvmt Flow	367	9	6	404	18	13

Major/Minor

	Major1	Major2	Minor1		
Conflicting Flow All	0	0	376	0	788
Stage 1	-	-	-	-	372
Stage 2	-	-	-	-	416
Critical Hdwy	-	-	4.12	-	6.42
Critical Hdwy Stg 1	-	-	-	-	5.42
Critical Hdwy Stg 2	-	-	-	-	5.42
Follow-up Hdwy	-	-	2.218	-	3.518
Pot Cap-1 Maneuver	-	-	1182	-	360
Stage 1	-	-	-	-	697
Stage 2	-	-	-	-	666
Platoon blocked, %	-	-	-	-	-
Mov Cap-1 Maneuver	-	-	1182	-	358
Mov Cap-2 Maneuver	-	-	-	-	358
Stage 1	-	-	-	-	694
Stage 2	-	-	-	-	666

Approach

	EB	WB	NB
HCM Control Delay, s	0	0.1	13.7
HCM LOS			B

Minor Lane/Major Mvmt

	NBLn1	EBT	EBR	WBL	WBT
Capacity (veh/h)	444	-	-	1182	-
HCM Lane V/C Ratio	0.069	-	-	0.005	-
HCM Control Delay (s)	13.7	-	-	8.1	-
HCM Lane LOS	B	-	-	A	-
HCM 95th %tile Q(veh)	0.2	-	-	0	-

HCM 6th Signalized Intersection Summary
 2: Crowfoot Valley Rd/Motsenbocker Rd & Stroh Rd

2037 Background Traffic
 PM Peak Hour

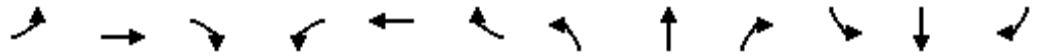

Movement	EBL	EBT	EBR	WBL	WBT	WBR	NBL	NBT	NBR	SBL	SBT	SBR
Lane Configurations												
Traffic Volume (veh/h)	145	490	95	955	465	250	290	225	825	270	352	225
Future Volume (veh/h)	145	490	95	955	465	250	290	225	825	270	352	225
Initial Q (Qb), veh	0	0	0	0	0	0	0	0	0	0	0	0
Ped-Bike Adj(A_pbT)	1.00		1.00	1.00		1.00	1.00		1.00	1.00		1.00
Parking Bus, Adj	1.00	1.00	1.00	1.00	1.00	1.00	1.00	1.00	1.00	1.00	1.00	1.00
Work Zone On Approach		No			No			No			No	
Adj Sat Flow, veh/h/ln	1870	1870	1870	1870	1870	1870	1870	1870	1870	1870	1870	1870
Adj Flow Rate, veh/h	153	516	100	1005	489	263	305	237	868	284	371	237
Peak Hour Factor	0.95	0.95	0.95	0.95	0.95	0.95	0.95	0.95	0.95	0.95	0.95	0.95
Percent Heavy Veh, %	2	2	2	2	2	2	2	2	2	2	2	2
Cap, veh/h	347	620	276	1037	1330	593	391	1187	992	325	1021	456
Arrive On Green	0.09	0.17	0.17	0.30	0.37	0.37	0.11	0.33	0.33	0.07	0.29	0.29
Sat Flow, veh/h	1781	3554	1585	3456	3554	1585	3456	3554	1585	1781	3554	1585
Grp Volume(v), veh/h	153	516	100	1005	489	263	305	237	868	284	371	237
Grp Sat Flow(s),veh/h/ln	1781	1777	1585	1728	1777	1585	1728	1777	1585	1781	1777	1585
Q Serve(g_s), s	8.3	16.8	6.7	34.4	12.0	14.9	10.3	5.7	40.1	8.0	10.0	15.0
Cycle Q Clear(g_c), s	8.3	16.8	6.7	34.4	12.0	14.9	10.3	5.7	40.1	8.0	10.0	15.0
Prop In Lane	1.00		1.00	1.00		1.00	1.00		1.00	1.00		1.00
Lane Grp Cap(c), veh/h	347	620	276	1037	1330	593	391	1187	992	325	1021	456
V/C Ratio(X)	0.44	0.83	0.36	0.97	0.37	0.44	0.78	0.20	0.88	0.87	0.36	0.52
Avail Cap(c_a), veh/h	347	681	304	1037	1392	621	461	1187	992	325	1021	456
HCM Platoon Ratio	1.00	1.00	1.00	1.00	1.00	1.00	1.00	1.00	1.00	1.00	1.00	1.00
Upstream Filter(I)	1.00	1.00	1.00	1.00	1.00	1.00	1.00	1.00	1.00	1.00	1.00	1.00
Uniform Delay (d), s/veh	35.4	47.8	43.7	41.5	27.2	28.2	51.7	28.5	18.6	35.1	34.0	35.8
Incr Delay (d2), s/veh	0.9	8.1	0.8	20.8	0.2	0.5	7.1	0.4	10.7	22.2	1.0	4.2
Initial Q Delay(d3),s/veh	0.0	0.0	0.0	0.0	0.0	0.0	0.0	0.0	0.0	0.0	0.0	0.0
%ile BackOfQ(50%),veh/ln	3.6	8.0	2.6	17.2	5.0	5.6	4.8	2.5	20.5	6.3	4.4	6.2
Unsig. Movement Delay, s/veh												
LnGrp Delay(d),s/veh	36.2	55.9	44.5	62.3	27.4	28.7	58.9	28.9	29.3	57.3	35.0	40.0
LnGrp LOS	D	E	D	E	C	C	E	C	C	E	D	D
Approach Vol, veh/h		769			1757			1410			892	
Approach Delay, s/veh		50.5			47.6			35.6			43.4	
Approach LOS		D			D			D			D	
Timer - Assigned Phs	1	2	3	4	5	6	7	8				
Phs Duration (G+Y+Rc), s	12.0	44.1	39.0	24.9	17.6	38.5	15.0	48.9				
Change Period (Y+Rc), s	5.0	5.0	5.0	5.0	5.0	5.0	5.0	5.0				
Max Green Setting (Gmax), s	7.0	37.0	34.0	22.0	15.0	29.0	10.0	46.0				
Max Q Clear Time (g_c+I1), s	10.0	42.1	36.4	18.8	12.3	17.0	10.3	16.9				
Green Ext Time (p_c), s	0.0	0.0	0.0	1.1	0.3	2.5	0.0	4.2				
Intersection Summary												
HCM 6th Ctrl Delay			43.8									
HCM 6th LOS			D									

HCM 6th Signalized Intersection Summary
 3: Crowfoot Valley Rd & Chambers Rd/Bayou Gulch Rd

2037 Background Traffic
 PM Peak Hour



Movement	EBL	EBT	EBR	WBL	WBT	WBR	NBL	NBT	NBR	SBL	SBT	SBR
Lane Configurations	↖↗	↑↑	↖	↖↗	↑↑	↖	↖↗	↑↑	↖	↖↗	↑↑	↖
Traffic Volume (veh/h)	205	883	1080	22	963	430	925	735	16	524	770	120
Future Volume (veh/h)	205	883	1080	22	963	430	925	735	16	524	770	120
Initial Q (Qb), veh	0	0	0	0	0	0	0	0	0	0	0	0
Ped-Bike Adj(A_pbT)	1.00		1.00	1.00		1.00	1.00		1.00	1.00		1.00
Parking Bus, Adj	1.00	1.00	1.00	1.00	1.00	1.00	1.00	1.00	1.00	1.00	1.00	1.00
Work Zone On Approach		No			No			No			No	
Adj Sat Flow, veh/h/ln	1870	1870	1870	1870	1870	1870	1870	1870	1870	1870	1870	1870
Adj Flow Rate, veh/h	216	929	1080	23	1014	0	925	774	17	552	811	126
Peak Hour Factor	0.95	0.95	1.00	0.95	0.95	0.95	1.00	0.95	0.95	0.95	0.95	0.95
Percent Heavy Veh, %	2	2	2	2	2	2	2	2	2	2	2	2
Cap, veh/h	259	1096	964	173	1036		950	1145	511	643	859	383
Arrive On Green	0.08	0.31	0.32	0.02	0.10	0.00	0.46	0.54	0.54	0.19	0.24	0.24
Sat Flow, veh/h	3456	3554	1585	3456	3554	1585	3456	3554	1585	3456	3554	1585
Grp Volume(v), veh/h	216	929	1080	23	1014	0	925	774	17	552	811	126
Grp Sat Flow(s),veh/h/ln	1728	1777	1585	1728	1777	1585	1728	1777	1585	1728	1777	1585
Q Serve(g_s), s	7.4	29.4	39.0	0.8	34.2	0.0	31.4	19.0	0.6	18.6	26.9	7.9
Cycle Q Clear(g_c), s	7.4	29.4	39.0	0.8	34.2	0.0	31.4	19.0	0.6	18.6	26.9	7.9
Prop In Lane	1.00		1.00	1.00		1.00	1.00		1.00	1.00		1.00
Lane Grp Cap(c), veh/h	259	1096	964	173	1036		950	1145	511	643	859	383
V/C Ratio(X)	0.83	0.85	1.12	0.13	0.98		0.97	0.68	0.03	0.86	0.94	0.33
Avail Cap(c_a), veh/h	259	1096	964	230	1036		950	1145	511	720	859	383
HCM Platoon Ratio	1.00	1.00	1.00	0.33	0.33	0.33	1.67	1.67	1.67	1.00	1.00	1.00
Upstream Filter(I)	1.00	1.00	1.00	1.00	1.00	0.00	0.67	0.67	0.67	1.00	1.00	1.00
Uniform Delay (d), s/veh	54.8	38.9	23.5	56.4	53.8	0.0	32.0	23.2	18.9	47.3	44.7	37.5
Incr Delay (d2), s/veh	20.2	6.4	67.9	0.3	22.7	0.0	17.8	2.2	0.1	9.4	19.8	2.3
Initial Q Delay(d3),s/veh	0.0	0.0	0.0	0.0	0.0	0.0	0.0	0.0	0.0	0.0	0.0	0.0
%ile BackOfQ(50%),veh/ln	8.9	13.6	43.2	0.4	19.6	0.0	13.4	6.8	0.2	8.8	14.1	3.3
Unsig. Movement Delay, s/veh												
LnGrp Delay(d),s/veh	75.0	45.2	91.4	56.8	76.6	0.0	49.9	25.3	19.0	56.7	64.5	39.8
LnGrp LOS	E	D	F	E	E		D	C	B	E	E	D
Approach Vol, veh/h		2225			1037	A		1716			1489	
Approach Delay, s/veh		70.5			76.1			38.5			59.5	
Approach LOS		E			E			D			E	
Timer - Assigned Phs	1	2	3	4	5	6	7	8				
Phs Duration (G+Y+Rc), s	36.3	42.7	10.0	41.0	36.0	33.0	12.0	39.0				
Change Period (Y+Rc), s	5.0	5.0	5.0	5.0	5.0	5.0	5.0	5.0				
Max Green Setting (Gmax), s	21.0	35.0	7.0	34.0	31.0	28.0	7.0	34.0				
Max Q Clear Time (g_c+20), s	20.6	21.0	2.8	41.0	33.4	28.9	9.4	36.2				
Green Ext Time (p_c), s	0.8	4.6	0.0	0.0	0.0	0.0	0.0	0.0				

Intersection Summary

HCM 6th Ctrl Delay	60.4
HCM 6th LOS	E

Notes

Unsignalized Delay for [WBR] is excluded from calculations of the approach delay and intersection delay.

HCM 6th Signalized Intersection Summary
 4: Crowfoot Valley Rd & Pinery Pkwy

2037 Background Traffic
 PM Peak Hour



Movement	WBL	WBR	NBT	NBR	SBL	SBT
Lane Configurations						
Traffic Volume (veh/h)	188	7	1677	161	13	1872
Future Volume (veh/h)	188	7	1677	161	13	1872
Initial Q (Qb), veh	0	0	0	0	0	0
Ped-Bike Adj(A_pbT)	1.00	1.00		1.00	1.00	
Parking Bus, Adj	1.00	1.00	1.00	1.00	1.00	1.00
Work Zone On Approach	No		No		No	
Adj Sat Flow, veh/h/ln	1870	1870	1870	1870	1870	1870
Adj Flow Rate, veh/h	198	0	1765	169	14	1971
Peak Hour Factor	0.95	0.95	0.95	0.95	0.95	0.95
Percent Heavy Veh, %	2	2	2	2	2	2
Cap, veh/h	230		2596	1158	194	2799
Arrive On Green	0.13	0.00	0.73	0.73	0.03	1.00
Sat Flow, veh/h	1781	1585	3647	1585	1781	3647
Grp Volume(v), veh/h	198	0	1765	169	14	1971
Grp Sat Flow(s),veh/h/ln	1781	1585	1777	1585	1781	1777
Q Serve(g_s), s	13.1	0.0	31.9	3.9	0.2	0.0
Cycle Q Clear(g_c), s	13.1	0.0	31.9	3.9	0.2	0.0
Prop In Lane	1.00	1.00		1.00	1.00	
Lane Grp Cap(c), veh/h	230		2596	1158	194	2799
V/C Ratio(X)	0.86		0.68	0.15	0.07	0.70
Avail Cap(c_a), veh/h	445		2596	1158	315	2799
HCM Platoon Ratio	1.00	1.00	1.00	1.00	2.00	2.00
Upstream Filter(I)	1.00	0.00	1.00	1.00	0.17	0.17
Uniform Delay (d), s/veh	51.2	0.0	8.7	4.9	8.4	0.0
Incr Delay (d2), s/veh	9.1	0.0	1.5	0.3	0.0	0.3
Initial Q Delay(d3),s/veh	0.0	0.0	0.0	0.0	0.0	0.0
%ile BackOfQ(50%),veh/ln	6.3	0.0	11.2	1.2	0.1	0.1
Unsig. Movement Delay, s/veh						
LnGrp Delay(d),s/veh	60.3	0.0	10.1	5.1	8.4	0.3
LnGrp LOS	E		B	A	A	A
Approach Vol, veh/h	198	A	1934			1985
Approach Delay, s/veh	60.3		9.7			0.3
Approach LOS	E		A			A
Timer - Assigned Phs	1	2			6	8
Phs Duration (G+Y+Rc), s	6.9	92.6			99.5	20.5
Change Period (Y+Rc), s	5.0	5.0			5.0	5.0
Max Green Setting (Gmax), s	10.0	65.0			80.0	30.0
Max Q Clear Time (g_c+1/2), s	12.2	33.9			2.0	15.1
Green Ext Time (p_c), s	0.0	19.5			35.6	0.4

Intersection Summary

HCM 6th Ctrl Delay		7.6	
HCM 6th LOS		A	

Notes

Unsignalized Delay for [WBR] is excluded from calculations of the approach delay and intersection delay.

HCM 6th Signalized Intersection Summary
5: Crowfoot Valley Rd & Pradera Pkwy

2037 Background Traffic
PM Peak Hour



Movement	WBL	WBR	NBT	NBR	SBL	SBT
Lane Configurations						
Traffic Volume (veh/h)	98	41	1669	144	66	1839
Future Volume (veh/h)	98	41	1669	144	66	1839
Initial Q (Qb), veh	0	0	0	0	0	0
Ped-Bike Adj(A_pbT)	1.00	1.00		1.00	1.00	
Parking Bus, Adj	1.00	1.00	1.00	1.00	1.00	1.00
Work Zone On Approach	No		No		No	
Adj Sat Flow, veh/h/ln	1870	1870	1870	1870	1870	1870
Adj Flow Rate, veh/h	103	43	1757	152	69	1936
Peak Hour Factor	0.95	0.95	0.95	0.95	0.95	0.95
Percent Heavy Veh, %	2	2	2	2	2	2
Cap, veh/h	134	120	2708	1208	251	2989
Arrive On Green	0.08	0.08	0.76	0.76	0.04	0.84
Sat Flow, veh/h	1781	1585	3647	1585	1781	3647
Grp Volume(v), veh/h	103	43	1757	152	69	1936
Grp Sat Flow(s),veh/h/ln	1781	1585	1777	1585	1781	1777
Q Serve(g_s), s	6.8	3.1	27.9	3.0	0.9	22.8
Cycle Q Clear(g_c), s	6.8	3.1	27.9	3.0	0.9	22.8
Prop In Lane	1.00	1.00		1.00	1.00	
Lane Grp Cap(c), veh/h	134	120	2708	1208	251	2989
V/C Ratio(X)	0.77	0.36	0.65	0.13	0.27	0.65
Avail Cap(c_a), veh/h	371	330	2708	1208	333	2989
HCM Platoon Ratio	1.00	1.00	1.00	1.00	1.00	1.00
Upstream Filter(I)	1.00	1.00	1.00	1.00	1.00	1.00
Uniform Delay (d), s/veh	54.4	52.7	6.7	3.8	7.4	3.3
Incr Delay (d2), s/veh	8.7	1.8	1.2	0.2	0.6	1.1
Initial Q Delay(d3),s/veh	0.0	0.0	0.0	0.0	0.0	0.0
%ile BackOfQ(50%),veh/ln	8.3	1.3	7.7	0.8	0.5	3.7
Unsig. Movement Delay, s/veh						
LnGrp Delay(d),s/veh	63.2	54.5	7.9	4.0	8.0	4.4
LnGrp LOS	E	D	A	A	A	A
Approach Vol, veh/h	146		1909			2005
Approach Delay, s/veh	60.6		7.6			4.5
Approach LOS	E		A			A
Timer - Assigned Phs	1	2			6	8
Phs Duration (G+Y+Rc), s	9.5	96.4			105.9	14.1
Change Period (Y+Rc), s	5.0	5.0			5.0	5.0
Max Green Setting (Gmax), s	70.0	70.0			85.0	25.0
Max Q Clear Time (g_c+I), s	29.9	29.9			24.8	8.8
Green Ext Time (p_c), s	0.1	19.2			25.5	0.3

Intersection Summary

HCM 6th Ctrl Delay		8.0				
HCM 6th LOS			A			

HCM 6th Signalized Intersection Summary
7: Parker Rd & Pinery Pkwy

2037 Background Traffic
PM Peak Hour



Movement	EBL	EBT	EBR	WBL	WBT	WBR	NBL	NBT	NBR	SBL	SBT	SBR
Lane Configurations	↙↘	↑	↗	↙	↘		↙↑↑↑			↙↘	↑↑↑	↗
Traffic Volume (veh/h)	35	125	171	50	50	200	67	1175	35	420	1975	60
Future Volume (veh/h)	35	125	171	50	50	200	67	1175	35	420	1975	60
Initial Q (Qb), veh	0	0	0	0	0	0	0	0	0	0	0	0
Ped-Bike Adj(A_pbT)	1.00		1.00	1.00		1.00	1.00		1.00	1.00		1.00
Parking Bus, Adj	1.00	1.00	1.00	1.00	1.00	1.00	1.00	1.00	1.00	1.00	1.00	1.00
Work Zone On Approach		No			No		No		No		No	
Adj Sat Flow, veh/h/ln	1870	1870	1870	1870	1870	1870	1870	1870	1870	1870	1870	1870
Adj Flow Rate, veh/h	37	132	0	53	53	211	71	1237	37	442	2079	0
Peak Hour Factor	0.95	0.95	0.95	0.95	0.95	0.95	0.95	0.95	0.95	0.95	0.95	0.95
Percent Heavy Veh, %	2	2	2	2	2	2	2	2	2	2	2	2
Cap, veh/h	131	340		287	61	244	105	2443	73	475	2850	
Arrive On Green	0.04	0.18	0.00	0.04	0.19	0.19	0.06	0.48	0.47	0.14	0.56	0.00
Sat Flow, veh/h	3456	1870	1585	1781	328	1307	1781	5095	152	3456	5106	1585
Grp Volume(v), veh/h	37	132	0	53	0	264	71	826	448	442	2079	0
Grp Sat Flow(s),veh/h/ln	1728	1870	1585	1781	0	1635	1781	1702	1843	1728	1702	1585
Q Serve(g_s), s	1.2	7.5	0.0	2.9	0.0	18.8	4.7	20.0	20.0	15.2	36.4	0.0
Cycle Q Clear(g_c), s	1.2	7.5	0.0	2.9	0.0	18.8	4.7	20.0	20.0	15.2	36.4	0.0
Prop In Lane	1.00		1.00	1.00		0.80	1.00		0.08	1.00		1.00
Lane Grp Cap(c), veh/h	131	340		287	0	305	105	1633	884	475	2850	
V/C Ratio(X)	0.28	0.39		0.18	0.00	0.86	0.68	0.51	0.51	0.93	0.73	
Avail Cap(c_a), veh/h	302	405		366	0	354	156	1633	884	475	2850	
HCM Platoon Ratio	1.00	1.00	1.00	1.00	1.00	1.00	1.00	1.00	1.00	1.00	1.00	1.00
Upstream Filter(I)	1.00	1.00	0.00	1.00	0.00	1.00	1.00	1.00	1.00	1.00	1.00	0.00
Uniform Delay (d), s/veh	56.1	43.2	0.0	37.4	0.0	47.3	55.3	21.5	21.5	51.2	19.8	0.0
Incr Delay (d2), s/veh	1.2	0.7	0.0	0.3	0.0	17.6	7.3	1.1	2.1	25.0	1.7	0.0
Initial Q Delay(d3),s/veh	0.0	0.0	0.0	0.0	0.0	0.0	0.0	0.0	0.0	0.0	0.0	0.0
%ile BackOfQ(50%),veh/ln	0.6	3.5	0.0	1.3	0.0	9.2	2.2	7.5	8.4	7.9	13.0	0.0
Unsig. Movement Delay, s/veh												
LnGrp Delay(d),s/veh	57.3	44.0	0.0	37.7	0.0	64.9	62.6	22.6	23.6	76.2	21.4	0.0
LnGrp LOS	E	D		D	A	E	E	C	C	E	C	
Approach Vol, veh/h		169	A		317		1345			2521	A	
Approach Delay, s/veh		46.9			60.4		25.0			31.0		
Approach LOS		D			E		C			C		
Timer - Assigned Phs	1	2	3	4	5	6	7	8				
Phs Duration (G+Y+Rc), s	31.0	63.6	9.6	25.8	11.6	73.0	9.0	26.4				
Change Period (Y+Rc), s	5.5	7.0	5.5	5.0	5.5	7.0	5.5	5.0				
Max Green Setting (Gmax), s	15.5	47.0	9.5	25.0	9.5	53.0	9.5	25.0				
Max Q Clear Time (g_c+I), s	17.2	22.0	4.9	9.5	6.7	38.4	3.2	20.8				
Green Ext Time (p_c), s	0.0	8.1	0.0	0.5	0.0	10.8	0.0	0.6				

Intersection Summary

HCM 6th Ctrl Delay	31.9
HCM 6th LOS	C

Notes

Unsignalized Delay for [EBR, SBR] is excluded from calculations of the approach delay and intersection delay.

HCM 6th Signalized Intersection Summary
 8: Bayou Gulch Rd & Pinery Pkwy

2037 Background Traffic
 PM Peak Hour



Movement	EBL	EBT	EBR	WBL	WBT	WBR	NBL	NBT	NBR	SBL	SBT	SBR
Lane Configurations												
Traffic Volume (veh/h)	133	20	21	9	3	78	16	1188	11	412	820	176
Future Volume (veh/h)	133	20	21	9	3	78	16	1188	11	412	820	176
Initial Q (Qb), veh	0	0	0	0	0	0	0	0	0	0	0	0
Ped-Bike Adj(A_pbT)	1.00		1.00	1.00		1.00	1.00		1.00	1.00		1.00
Parking Bus, Adj	1.00	1.00	1.00	1.00	1.00	1.00	1.00	1.00	1.00	1.00	1.00	1.00
Work Zone On Approach		No			No			No			No	
Adj Sat Flow, veh/h/ln	1870	1870	1870	1870	1870	1870	1870	1870	1870	1870	1870	1870
Adj Flow Rate, veh/h	140	21	22	9	3	82	17	1251	12	434	863	185
Peak Hour Factor	0.95	0.95	0.95	0.95	0.95	0.95	0.95	0.95	0.95	0.95	0.95	0.95
Percent Heavy Veh, %	2	2	2	2	2	2	2	2	2	2	2	2
Cap, veh/h	312	249	211	162	114	331	368	1952	858	541	2415	1064
Arrive On Green	0.09	0.13	0.13	0.01	0.06	0.06	0.02	0.55	0.54	0.10	0.46	0.45
Sat Flow, veh/h	1781	1870	1585	1781	1870	1585	1781	3554	1585	3456	3554	1585
Grp Volume(v), veh/h	140	21	22	9	3	82	17	1251	12	434	863	185
Grp Sat Flow(s),veh/h/ln	1781	1870	1585	1781	1870	1585	1781	1777	1585	1728	1777	1585
Q Serve(g_s), s	8.4	1.2	1.5	0.6	0.2	5.2	0.5	29.4	0.4	14.7	19.0	8.4
Cycle Q Clear(g_c), s	8.4	1.2	1.5	0.6	0.2	5.2	0.5	29.4	0.4	14.7	19.0	8.4
Prop In Lane	1.00		1.00	1.00		1.00	1.00		1.00	1.00		1.00
Lane Grp Cap(c), veh/h	312	249	211	162	114	331	368	1952	858	541	2415	1064
V/C Ratio(X)	0.45	0.08	0.10	0.06	0.03	0.25	0.05	0.64	0.01	0.80	0.36	0.17
Avail Cap(c_a), veh/h	312	390	330	291	390	565	485	1952	858	749	2415	1064
HCM Platoon Ratio	1.00	1.00	1.00	1.00	1.00	1.00	1.00	1.00	1.00	0.67	0.67	0.67
Upstream Filter(I)	1.00	1.00	1.00	1.00	1.00	1.00	1.00	1.00	1.00	1.00	1.00	1.00
Uniform Delay (d), s/veh	44.1	45.6	45.7	52.0	53.0	39.6	11.8	18.8	12.7	51.9	15.6	13.2
Incr Delay (d2), s/veh	1.0	0.1	0.2	0.1	0.1	0.4	0.1	1.6	0.0	4.4	0.4	0.4
Initial Q Delay(d3),s/veh	0.0	0.0	0.0	0.0	0.0	0.0	0.0	0.0	0.0	0.0	0.0	0.0
%ile BackOfQ(50%),veh/ln	3.7	0.6	0.6	0.3	0.1	2.0	0.2	12.2	0.2	6.9	8.5	3.0
Unsig. Movement Delay, s/veh												
LnGrp Delay(d),s/veh	45.1	45.7	45.9	52.1	53.1	40.0	11.9	20.4	12.8	56.3	16.0	13.5
LnGrp LOS	D	D	D	D	D	D	B	C	B	E	B	B
Approach Vol, veh/h		183			94			1280			1482	
Approach Delay, s/veh		45.3			41.6			20.2			27.5	
Approach LOS		D			D			C			C	
Timer - Assigned Phs	1	2	3	4	5	6	7	8				
Phs Duration (G+Y+Rc), s	22.8	69.9	6.3	21.0	7.2	85.5	15.0	12.3				
Change Period (Y+Rc), s	5.0	5.0	5.0	5.0	5.0	5.0	5.0	5.0				
Max Green Setting (Gmax), s	25.0	40.0	10.0	25.0	10.0	55.0	10.0	25.0				
Max Q Clear Time (g_c+10), s	11.0	31.4	2.6	3.5	2.5	21.0	10.4	7.2				
Green Ext Time (p_c), s	1.1	5.4	0.0	0.1	0.0	8.1	0.0	0.2				

Intersection Summary

HCM 6th Ctrl Delay	26.0
HCM 6th LOS	C

Intersection						
Int Delay, s/veh	0.6					
Movement	EBT	EBR	WBL	WBT	NBL	NBR
Lane Configurations						
Traffic Vol, veh/h	349	9	6	384	17	12
Future Vol, veh/h	349	9	6	384	17	12
Conflicting Peds, #/hr	0	0	0	0	0	0
Sign Control	Free	Free	Free	Free	Stop	Stop
RT Channelized	-	None	-	None	-	None
Storage Length	-	-	0	-	0	-
Veh in Median Storage, #	0	-	-	0	0	-
Grade, %	0	-	-	0	0	-
Peak Hour Factor	95	95	95	95	95	95
Heavy Vehicles, %	2	2	2	2	2	2
Mvmt Flow	367	9	6	404	18	13

Major/Minor	Major1	Major2	Minor1			
Conflicting Flow All	0	0	376	0	788	372
Stage 1	-	-	-	-	372	-
Stage 2	-	-	-	-	416	-
Critical Hdwy	-	-	4.12	-	6.42	6.22
Critical Hdwy Stg 1	-	-	-	-	5.42	-
Critical Hdwy Stg 2	-	-	-	-	5.42	-
Follow-up Hdwy	-	-	2.218	-	3.518	3.318
Pot Cap-1 Maneuver	-	-	1182	-	360	674
Stage 1	-	-	-	-	697	-
Stage 2	-	-	-	-	666	-
Platoon blocked, %	-	-	-	-	-	-
Mov Cap-1 Maneuver	-	-	1182	-	358	674
Mov Cap-2 Maneuver	-	-	-	-	358	-
Stage 1	-	-	-	-	694	-
Stage 2	-	-	-	-	666	-

Approach	EB	WB	NB
HCM Control Delay, s	0	0.1	13.7
HCM LOS			B

Minor Lane/Major Mvmt	NBLn1	EBT	EBR	WBL	WBT
Capacity (veh/h)	444	-	-	1182	-
HCM Lane V/C Ratio	0.069	-	-	0.005	-
HCM Control Delay (s)	13.7	-	-	8.1	-
HCM Lane LOS	B	-	-	A	-
HCM 95th %tile Q(veh)	0.2	-	-	0	-

HCM 6th Signalized Intersection Summary
 2: Crowfoot Valley Rd/Motsenbocker Rd & Stroh Rd

2037 Total Traffic
 AM Peak Hour

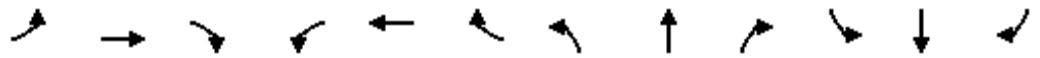

Movement	EBL	EBT	EBR	WBL	WBT	WBR	NBL	NBT	NBR	SBL	SBT	SBR
Lane Configurations												
Traffic Volume (veh/h)	60	380	125	600	215	250	75	403	815	100	223	25
Future Volume (veh/h)	60	380	125	600	215	250	75	403	815	100	223	25
Initial Q (Qb), veh	0	0	0	0	0	0	0	0	0	0	0	0
Ped-Bike Adj(A_pbT)	1.00		1.00	1.00		1.00	1.00		1.00	1.00		1.00
Parking Bus, Adj	1.00	1.00	1.00	1.00	1.00	1.00	1.00	1.00	1.00	1.00	1.00	1.00
Work Zone On Approach		No			No			No			No	
Adj Sat Flow, veh/h/ln	1870	1870	1870	1870	1870	1870	1870	1870	1870	1870	1870	1870
Adj Flow Rate, veh/h	63	400	132	632	226	263	79	424	858	105	235	26
Peak Hour Factor	0.95	0.95	0.95	0.95	0.95	0.95	0.95	0.95	0.95	0.95	0.95	0.95
Percent Heavy Veh, %	2	2	2	2	2	2	2	2	2	2	2	2
Cap, veh/h	286	545	318	736	1129	504	162	1582	1043	318	1611	718
Arrive On Green	0.05	0.15	0.15	0.21	0.32	0.32	0.05	0.45	0.45	0.06	0.45	0.45
Sat Flow, veh/h	1781	3554	1585	3456	3554	1585	3456	3554	1585	1781	3554	1585
Grp Volume(v), veh/h	63	400	132	632	226	263	79	424	858	105	235	26
Grp Sat Flow(s),veh/h/ln	1781	1777	1585	1728	1777	1585	1728	1777	1585	1781	1777	1585
Q Serve(g_s), s	3.5	12.9	8.7	21.1	5.6	16.3	2.7	9.0	48.4	3.8	4.6	1.1
Cycle Q Clear(g_c), s	3.5	12.9	8.7	21.1	5.6	16.3	2.7	9.0	48.4	3.8	4.6	1.1
Prop In Lane	1.00		1.00	1.00		1.00	1.00		1.00	1.00		1.00
Lane Grp Cap(c), veh/h	286	545	318	736	1129	504	162	1582	1043	318	1611	718
V/C Ratio(X)	0.22	0.73	0.42	0.86	0.20	0.52	0.49	0.27	0.82	0.33	0.15	0.04
Avail Cap(c_a), veh/h	318	918	484	893	1599	713	230	1582	1043	338	1611	718
HCM Platoon Ratio	1.00	1.00	1.00	1.00	1.00	1.00	1.00	1.00	1.00	1.00	1.00	1.00
Upstream Filter(I)	1.00	1.00	1.00	1.00	1.00	1.00	1.00	1.00	1.00	1.00	1.00	1.00
Uniform Delay (d), s/veh	39.6	48.5	41.9	45.5	29.8	33.5	55.8	21.0	15.3	16.4	19.2	18.2
Incr Delay (d2), s/veh	0.4	1.9	0.9	7.2	0.1	0.8	2.2	0.4	7.3	0.6	0.2	0.1
Initial Q Delay(d3),s/veh	0.0	0.0	0.0	0.0	0.0	0.0	0.0	0.0	0.0	0.0	0.0	0.0
%ile BackOfQ(50%),veh/ln	1.5	5.8	3.4	9.6	2.4	6.2	1.2	3.8	17.2	1.6	1.9	0.4
Unsig. Movement Delay, s/veh												
LnGrp Delay(d),s/veh	40.0	50.4	42.7	52.7	29.9	34.3	58.0	21.4	22.6	17.0	19.4	18.3
LnGrp LOS	D	D	D	D	C	C	E	C	C	B	B	B
Approach Vol, veh/h		595			1121			1361			366	
Approach Delay, s/veh		47.6			43.8			24.3			18.6	
Approach LOS		D			D			C			B	
Timer - Assigned Phs	1	2	3	4	5	6	7	8				
Phs Duration (G+Y+Rc), s	10.6	57.4	29.6	22.4	9.6	58.4	9.8	42.1				
Change Period (Y+Rc), s	5.0	5.0	5.0	5.0	5.0	5.0	5.0	5.0				
Max Green Setting (Gmax), s	7.0	33.0	30.0	30.0	7.0	33.0	7.0	53.0				
Max Q Clear Time (g_c+I1), s	5.8	50.4	23.1	14.9	4.7	6.6	5.5	18.3				
Green Ext Time (p_c), s	0.0	0.0	1.4	2.5	0.0	1.5	0.0	2.3				

Intersection Summary

HCM 6th Ctrl Delay	34.1
HCM 6th LOS	C

HCM 6th Signalized Intersection Summary
 3: Crowfoot Valley Rd & Chambers Rd/Bayou Gulch Rd

2037 Total Traffic
 AM Peak Hour



Movement	EBL	EBT	EBR	WBL	WBT	WBR	NBL	NBT	NBR	SBL	SBT	SBR
Lane Configurations	↖↗	↑↑	↖	↖↗	↑↑	↖	↖↗	↑↑	↖	↖↗	↑↑	↖
Traffic Volume (veh/h)	110	717	790	100	899	441	982	833	85	372	466	60
Future Volume (veh/h)	110	717	790	100	899	441	982	833	85	372	466	60
Initial Q (Qb), veh	0	0	0	0	0	0	0	0	0	0	0	0
Ped-Bike Adj(A_pbT)	1.00		1.00	1.00		1.00	1.00		1.00	1.00		1.00
Parking Bus, Adj	1.00	1.00	1.00	1.00	1.00	1.00	1.00	1.00	1.00	1.00	1.00	1.00
Work Zone On Approach		No			No			No			No	
Adj Sat Flow, veh/h/ln	1870	1870	1870	1870	1870	1870	1870	1870	1870	1870	1870	1870
Adj Flow Rate, veh/h	116	755	832	105	946	0	1034	877	89	392	491	63
Peak Hour Factor	0.95	0.95	0.95	0.95	0.95	0.95	0.95	0.95	0.95	0.95	0.95	0.95
Percent Heavy Veh, %	2	2	2	2	2	2	2	2	2	2	2	2
Cap, veh/h	199	1066	964	193	1060		1037	1341	598	461	779	347
Arrive On Green	0.06	0.30	0.31	0.02	0.10	0.00	0.50	0.63	0.63	0.13	0.22	0.22
Sat Flow, veh/h	3456	3554	1585	3456	3554	1585	3456	3554	1585	3456	3554	1585
Grp Volume(v), veh/h	116	755	832	105	946	0	1034	877	89	392	491	63
Grp Sat Flow(s),veh/h/ln	1728	1777	1585	1728	1777	1585	1728	1777	1585	1728	1777	1585
Q Serve(g_s), s	3.9	22.7	37.0	3.6	31.6	0.0	35.8	18.6	2.7	13.3	15.0	3.9
Cycle Q Clear(g_c), s	3.9	22.7	37.0	3.6	31.6	0.0	35.8	18.6	2.7	13.3	15.0	3.9
Prop In Lane	1.00		1.00	1.00		1.00	1.00		1.00	1.00		1.00
Lane Grp Cap(c), veh/h	199	1066	964	193	1060		1037	1341	598	461	779	347
V/C Ratio(X)	0.58	0.71	0.86	0.54	0.89		1.00	0.65	0.15	0.85	0.63	0.18
Avail Cap(c_a), veh/h	317	1066	964	317	1066		1037	1341	598	461	779	347
HCM Platoon Ratio	1.00	1.00	1.00	0.33	0.33	0.33	1.67	1.67	1.67	1.00	1.00	1.00
Upstream Filter(I)	1.00	1.00	1.00	1.00	1.00	0.00	0.64	0.64	0.64	1.00	1.00	1.00
Uniform Delay (d), s/veh	55.1	37.3	19.4	57.4	52.2	0.0	29.9	17.3	14.3	50.8	42.5	38.1
Incr Delay (d2), s/veh	2.7	2.2	8.1	2.4	9.6	0.0	21.7	1.6	0.3	14.1	3.9	1.1
Initial Q Delay(d3),s/veh	0.0	0.0	0.0	0.0	0.0	0.0	0.0	0.0	0.0	0.0	0.0	0.0
%ile BackOfQ(50%),veh/ln	1.8	10.1	20.0	1.7	16.5	0.0	15.3	5.9	1.0	6.6	7.0	1.6
Unsig. Movement Delay, s/veh												
LnGrp Delay(d),s/veh	57.8	39.5	27.5	59.7	61.8	0.0	51.6	18.9	14.7	64.9	46.3	39.3
LnGrp LOS	E	D	C	E	E		D	B	B	E	D	D
Approach Vol, veh/h		1703			1051	A		2000			946	
Approach Delay, s/veh		34.9			61.6			35.6			53.6	
Approach LOS		C			E			D			D	
Timer - Assigned Phs	1	2	3	4	5	6	7	8				
Phs Duration (G+Y+Rc), s	30.0	49.3	10.7	40.0	39.0	30.3	10.9	39.8				
Change Period (Y+Rc), s	5.0	5.0	5.0	5.0	5.0	5.0	5.0	5.0				
Max Green Setting (Gmax), s	15.0	40.0	10.0	35.0	34.0	21.0	10.0	35.0				
Max Q Clear Time (g_c+1/3), s	11.3	20.6	5.6	39.0	37.8	17.0	5.9	33.6				
Green Ext Time (p_c), s	0.0	6.5	0.1	0.0	0.0	1.3	0.1	0.9				

Intersection Summary

HCM 6th Ctrl Delay	43.2
HCM 6th LOS	D

Notes

Unsignalized Delay for [WBR] is excluded from calculations of the approach delay and intersection delay.

HCM 6th Signalized Intersection Summary
 4: Crowfoot Valley Rd & Pinery Pkwy

2037 Total Traffic
 AM Peak Hour



Movement	WBL	WBR	NBT	NBR	SBL	SBT
Lane Configurations						
Traffic Volume (veh/h)	127	131	1810	115	30	1430
Future Volume (veh/h)	127	131	1810	115	30	1430
Initial Q (Qb), veh	0	0	0	0	0	0
Ped-Bike Adj(A_pbT)	1.00	1.00		1.00	1.00	
Parking Bus, Adj	1.00	1.00	1.00	1.00	1.00	1.00
Work Zone On Approach	No		No		No	
Adj Sat Flow, veh/h/ln	1870	1870	1870	1870	1870	1870
Adj Flow Rate, veh/h	134	0	1905	121	32	1505
Peak Hour Factor	0.95	0.95	0.95	0.95	0.95	0.95
Percent Heavy Veh, %	2	2	2	2	2	2
Cap, veh/h	163		2687	1198	208	2932
Arrive On Green	0.09	0.00	0.76	0.76	0.05	1.00
Sat Flow, veh/h	1781	1585	3647	1585	1781	3647
Grp Volume(v), veh/h	134	0	1905	121	32	1505
Grp Sat Flow(s),veh/h/ln	1781	1585	1777	1585	1781	1777
Q Serve(g_s), s	8.9	0.0	33.8	2.4	0.4	0.0
Cycle Q Clear(g_c), s	8.9	0.0	33.8	2.4	0.4	0.0
Prop In Lane	1.00	1.00		1.00	1.00	
Lane Grp Cap(c), veh/h	163		2687	1198	208	2932
V/C Ratio(X)	0.82		0.71	0.10	0.15	0.51
Avail Cap(c_a), veh/h	371		2687	1198	263	2932
HCM Platoon Ratio	1.00	1.00	1.00	1.00	2.00	2.00
Upstream Filter(l)	1.00	0.00	1.00	1.00	0.58	0.58
Uniform Delay (d), s/veh	53.5	0.0	7.7	3.9	8.5	0.0
Incr Delay (d2), s/veh	9.7	0.0	1.6	0.2	0.2	0.4
Initial Q Delay(d3),s/veh	0.0	0.0	0.0	0.0	0.0	0.0
%ile BackOfQ(50%),veh/ln	4.3	0.0	11.4	0.7	0.3	0.2
Unsig. Movement Delay, s/veh						
LnGrp Delay(d),s/veh	63.3	0.0	9.3	4.0	8.7	0.4
LnGrp LOS	E		A	A	A	A
Approach Vol, veh/h	134	A	2026			1537
Approach Delay, s/veh	63.3		9.0			0.5
Approach LOS	E		A			A
Timer - Assigned Phs	1	2			6	8
Phs Duration (G+Y+Rc), s	8.3	95.7			104.0	16.0
Change Period (Y+Rc), s	5.0	5.0			5.0	5.0
Max Green Setting (Gmax), s	73.0				85.0	25.0
Max Q Clear Time (g_c+1), s	35.8				2.0	10.9
Green Ext Time (p_c), s	0.0	23.7			20.1	0.3

Intersection Summary

HCM 6th Ctrl Delay		7.5				
HCM 6th LOS			A			

Notes

Unsignalized Delay for [WBR] is excluded from calculations of the approach delay and intersection delay.

HCM 6th Signalized Intersection Summary
5: Crowfoot Valley Rd & Pradera Pkwy

2037 Total Traffic
AM Peak Hour



Movement	WBL	WBR	NBT	NBR	SBL	SBT
Lane Configurations						
Traffic Volume (veh/h)	157	117	1730	64	20	1502
Future Volume (veh/h)	157	117	1730	64	20	1502
Initial Q (Qb), veh	0	0	0	0	0	0
Ped-Bike Adj(A_pbT)	1.00	1.00		1.00	1.00	
Parking Bus, Adj	1.00	1.00	1.00	1.00	1.00	1.00
Work Zone On Approach	No		No		No	
Adj Sat Flow, veh/h/ln	1870	1870	1870	1870	1870	1870
Adj Flow Rate, veh/h	165	123	1821	67	21	1581
Peak Hour Factor	0.95	0.95	0.95	0.95	0.95	0.95
Percent Heavy Veh, %	2	2	2	2	2	2
Cap, veh/h	201	179	2634	1175	210	2857
Arrive On Green	0.11	0.11	0.74	0.74	0.02	0.80
Sat Flow, veh/h	1781	1585	3647	1585	1781	3647
Grp Volume(v), veh/h	165	123	1821	67	21	1581
Grp Sat Flow(s),veh/h/ln	1781	1585	1777	1585	1781	1777
Q Serve(g_s), s	10.9	9.0	32.6	1.4	0.3	18.9
Cycle Q Clear(g_c), s	10.9	9.0	32.6	1.4	0.3	18.9
Prop In Lane	1.00	1.00		1.00	1.00	
Lane Grp Cap(c), veh/h	201	179	2634	1175	210	2857
V/C Ratio(X)	0.82	0.69	0.69	0.06	0.10	0.55
Avail Cap(c_a), veh/h	371	330	2634	1175	277	2857
HCM Platoon Ratio	1.00	1.00	1.00	1.00	1.00	1.00
Upstream Filter(I)	1.00	1.00	1.00	1.00	1.00	1.00
Uniform Delay (d), s/veh	52.1	51.2	8.2	4.2	8.4	4.2
Incr Delay (d2), s/veh	8.1	4.6	1.5	0.1	0.2	0.8
Initial Q Delay(d3),s/veh	0.0	0.0	0.0	0.0	0.0	0.0
%ile BackOfQ(50%),veh/ln	5.2	3.7	9.6	0.4	0.1	4.2
Unsig. Movement Delay, s/veh						
LnGrp Delay(d),s/veh	60.1	55.9	9.8	4.3	8.6	4.9
LnGrp LOS	E	E	A	A	A	A
Approach Vol, veh/h	288		1888			1602
Approach Delay, s/veh	58.3		9.6			5.0
Approach LOS	E		A			A
Timer - Assigned Phs	1	2			6	8
Phs Duration (G+Y+Rc), s	7.5	94.0			101.5	18.5
Change Period (Y+Rc), s	5.0	5.0			5.0	5.0
Max Green Setting (Gmax), s	73.0				85.0	25.0
Max Q Clear Time (g_c+1/2), s	34.6				20.9	12.9
Green Ext Time (p_c), s	0.0	19.4			17.1	0.7

Intersection Summary

HCM 6th Ctrl Delay		11.3				
HCM 6th LOS			B			

HCM 6th Signalized Intersection Summary
7: Parker Rd & Pinery Pkwy

2037 Total Traffic
AM Peak Hour



Movement	EBL	EBT	EBR	WBL	WBT	WBR	NBL	NBT	NBR	SBL	SBT	SBR
Lane Configurations	↔↔	↑	↗	↖	↖		↖↑↑↑			↗↗	↑↑↑	↗
Traffic Volume (veh/h)	136	30	125	75	125	325	151	2180	70	90	800	65
Future Volume (veh/h)	136	30	125	75	125	325	151	2180	70	90	800	65
Initial Q (Qb), veh	0	0	0	0	0	0	0	0	0	0	0	0
Ped-Bike Adj(A_pbT)	1.00		1.00	1.00		1.00	1.00		1.00	1.00		1.00
Parking Bus, Adj	1.00	1.00	1.00	1.00	1.00	1.00	1.00	1.00	1.00	1.00	1.00	1.00
Work Zone On Approach		No			No			No			No	
Adj Sat Flow, veh/h/ln	1870	1870	1870	1870	1870	1870	1870	1870	1870	1870	1870	1870
Adj Flow Rate, veh/h	143	32	0	79	132	342	159	2295	74	95	842	0
Peak Hour Factor	0.95	0.95	0.95	0.95	0.95	0.95	0.95	0.95	0.95	0.95	0.95	0.95
Percent Heavy Veh, %	2	2	2	2	2	2	2	2	2	2	2	2
Cap, veh/h	227	432		457	104	269	200	2629	84	174	2325	
Arrive On Green	0.07	0.23	0.00	0.06	0.22	0.22	0.11	0.52	0.52	0.05	0.46	0.00
Sat Flow, veh/h	3456	1870	1585	1781	461	1194	1781	5082	163	3456	5106	1585
Grp Volume(v), veh/h	143	32	0	79	0	474	159	1534	835	95	842	0
Grp Sat Flow(s),veh/h/ln	1728	1870	1585	1781	0	1655	1781	1702	1841	1728	1702	1585
Q Serve(g_s), s	4.8	1.6	0.0	4.1	0.0	27.0	10.4	47.5	48.1	3.2	12.9	0.0
Cycle Q Clear(g_c), s	4.8	1.6	0.0	4.1	0.0	27.0	10.4	47.5	48.1	3.2	12.9	0.0
Prop In Lane	1.00		1.00	1.00		0.72	1.00		0.09	1.00		1.00
Lane Grp Cap(c), veh/h	227	432		457	0	372	200	1761	952	174	2325	
V/C Ratio(X)	0.63	0.07		0.17	0.00	1.27	0.80	0.87	0.88	0.55	0.36	
Avail Cap(c_a), veh/h	317	432		529	0	372	238	1761	952	230	2325	
HCM Platoon Ratio	1.00	1.00	1.00	1.00	1.00	1.00	1.00	1.00	1.00	1.00	1.00	1.00
Upstream Filter(I)	1.00	1.00	0.00	1.00	0.00	1.00	1.00	1.00	1.00	1.00	1.00	0.00
Uniform Delay (d), s/veh	54.6	36.1	0.0	33.3	0.0	46.9	51.9	25.5	25.6	55.6	21.3	0.0
Incr Delay (d2), s/veh	2.9	0.1	0.0	0.2	0.0	142.2	14.6	6.2	11.2	2.7	0.4	0.0
Initial Q Delay(d3),s/veh	0.0	0.0	0.0	0.0	0.0	0.0	0.0	0.0	0.0	0.0	0.0	0.0
%ile BackOfQ(50%),veh/ln	2.2	0.7	0.0	1.8	0.0	25.9	5.3	18.4	21.4	1.4	4.8	0.0
Unsig. Movement Delay, s/veh												
LnGrp Delay(d),s/veh	57.5	36.2	0.0	33.4	0.0	189.0	66.5	31.7	36.8	58.3	21.8	0.0
LnGrp LOS	E	D		C	A	F	E	C	D	E	C	
Approach Vol, veh/h		175	A		553		2528			937	A	
Approach Delay, s/veh		53.6			166.8		35.6			25.5		
Approach LOS		D			F		D			C		
Timer - Assigned Phs	1	2	3	4	5	6	7	8				
Phs Duration (G+Y+Rc), s	60.0	68.1	10.2	31.7	17.5	60.6	11.9	30.0				
Change Period (Y+Rc), s	5.0	7.0	4.5	5.0	5.0	7.0	5.0	5.0				
Max Green Setting (Gmax), s	56.0	10.5	25.0	15.0	48.0	10.0	25.0					
Max Q Clear Time (g_c+1/2), s	50.1	6.1	3.6	12.4	14.9	6.8	29.0					
Green Ext Time (p_c), s	0.0	5.2	0.1	0.1	0.1	5.6	0.1	0.0				

Intersection Summary

HCM 6th Ctrl Delay	51.4
HCM 6th LOS	D

Notes

Unsignalized Delay for [EBR, SBR] is excluded from calculations of the approach delay and intersection delay.

HCM 6th Signalized Intersection Summary
8: Bayou Gulch Rd & Pinery Pkwy

2037 Total Traffic
AM Peak Hour



Movement	EBL	EBT	EBR	WBL	WBT	WBR	NBL	NBT	NBR	SBL	SBT	SBR
Lane Configurations												
Traffic Volume (veh/h)	130	69	15	14	52	390	23	822	28	353	739	65
Future Volume (veh/h)	130	69	15	14	52	390	23	822	28	353	739	65
Initial Q (Qb), veh	0	0	0	0	0	0	0	0	0	0	0	0
Ped-Bike Adj(A_pbT)	1.00		1.00	1.00		1.00	1.00		1.00	1.00		1.00
Parking Bus, Adj	1.00	1.00	1.00	1.00	1.00	1.00	1.00	1.00	1.00	1.00	1.00	1.00
Work Zone On Approach		No			No			No			No	
Adj Sat Flow, veh/h/ln	1870	1870	1870	1870	1870	1870	1870	1870	1870	1870	1870	1870
Adj Flow Rate, veh/h	137	73	16	15	55	411	24	865	29	372	778	68
Peak Hour Factor	0.95	0.95	0.95	0.95	0.95	0.95	0.95	0.95	0.95	0.95	0.95	0.95
Percent Heavy Veh, %	2	2	2	2	2	2	2	2	2	2	2	2
Cap, veh/h	411	567	481	430	466	612	318	1427	637	473	1803	804
Arrive On Green	0.08	0.30	0.30	0.02	0.25	0.25	0.03	0.40	0.40	0.05	0.17	0.17
Sat Flow, veh/h	1781	1870	1585	1781	1870	1585	1781	3554	1585	3456	3554	1585
Grp Volume(v), veh/h	137	73	16	15	55	411	24	865	29	372	778	68
Grp Sat Flow(s),veh/h/ln	1781	1870	1585	1781	1870	1585	1781	1777	1585	1728	1777	1585
Q Serve(g_s), s	6.6	3.4	0.9	0.7	2.7	25.8	0.9	23.1	1.3	12.8	23.6	4.3
Cycle Q Clear(g_c), s	6.6	3.4	0.9	0.7	2.7	25.8	0.9	23.1	1.3	12.8	23.6	4.3
Prop In Lane	1.00		1.00	1.00		1.00	1.00		1.00	1.00		1.00
Lane Grp Cap(c), veh/h	411	567	481	430	466	612	318	1427	637	473	1803	804
V/C Ratio(X)	0.33	0.13	0.03	0.03	0.12	0.67	0.08	0.61	0.05	0.79	0.43	0.08
Avail Cap(c_a), veh/h	433	567	481	549	561	693	426	1427	637	605	1803	804
HCM Platoon Ratio	1.00	1.00	1.00	1.00	1.00	1.00	1.00	1.00	1.00	0.33	0.33	0.33
Upstream Filter(I)	1.00	1.00	1.00	1.00	1.00	1.00	1.00	1.00	1.00	1.00	1.00	1.00
Uniform Delay (d), s/veh	28.0	30.3	29.4	31.9	34.9	30.6	20.1	28.4	21.9	55.5	34.4	26.4
Incr Delay (d2), s/veh	0.5	0.1	0.0	0.0	0.1	2.2	0.1	1.9	0.1	5.3	0.8	0.2
Initial Q Delay(d3),s/veh	0.0	0.0	0.0	0.0	0.0	0.0	0.0	0.0	0.0	0.0	0.0	0.0
%ile BackOfQ(50%),veh/ln	2.8	1.5	0.3	0.3	1.2	9.9	0.4	10.1	0.5	6.3	11.4	1.7
Unsig. Movement Delay, s/veh												
LnGrp Delay(d),s/veh	28.5	30.4	29.4	32.0	35.0	32.7	20.2	30.3	22.0	60.8	35.2	26.6
LnGrp LOS	C	C	C	C	C	C	C	C	C	E	D	C
Approach Vol, veh/h		226			481			918			1218	
Approach Delay, s/veh		29.2			32.9			29.8			42.5	
Approach LOS		C			C			C			D	
Timer - Assigned Phs	1	2	3	4	5	6	7	8				
Phs Duration (G+Y+Rc), s	30.4	52.2	7.0	40.4	7.8	64.9	13.5	33.9				
Change Period (Y+Rc), s	5.0	5.0	5.0	5.0	5.0	5.0	5.0	5.0				
Max Green Setting (Gmax), s	20.0	35.0	10.0	35.0	10.0	45.0	10.0	35.0				
Max Q Clear Time (g_c+M), s	14.8	25.1	2.7	5.4	2.9	25.6	8.6	27.8				
Green Ext Time (p_c), s	0.6	4.3	0.0	0.4	0.0	5.6	0.0	1.1				

Intersection Summary

HCM 6th Ctrl Delay		35.7										
HCM 6th LOS			D									

HCM 6th TWSC
 25: Bayou Gulch Rd & South Access

2037 Total Traffic
 AM Peak Hour

Intersection						
Int Delay, s/veh	0					
Movement	EBL	EBR	NBL	NBT	SBT	SBR
Lane Configurations		↗		↑↑	↑↑	
Traffic Vol, veh/h	0	3	0	824	764	20
Future Vol, veh/h	0	3	0	824	764	20
Conflicting Peds, #/hr	0	0	0	0	0	0
Sign Control	Stop	Stop	Free	Free	Free	Free
RT Channelized	-	None	-	None	-	None
Storage Length	-	0	-	-	-	-
Veh in Median Storage, #	0	-	-	0	0	-
Grade, %	0	-	-	0	0	-
Peak Hour Factor	95	95	95	96	95	95
Heavy Vehicles, %	2	2	2	2	2	2
Mvmt Flow	0	3	0	858	804	21

Major/Minor	Minor2	Major1	Major2		
Conflicting Flow All	-	413	-	0	-
Stage 1	-	-	-	-	-
Stage 2	-	-	-	-	-
Critical Hdwy	-	6.94	-	-	-
Critical Hdwy Stg 1	-	-	-	-	-
Critical Hdwy Stg 2	-	-	-	-	-
Follow-up Hdwy	-	3.32	-	-	-
Pot Cap-1 Maneuver	0	588	0	-	-
Stage 1	0	-	0	-	-
Stage 2	0	-	0	-	-
Platoon blocked, %				-	-
Mov Cap-1 Maneuver	-	588	-	-	-
Mov Cap-2 Maneuver	-	-	-	-	-
Stage 1	-	-	-	-	-
Stage 2	-	-	-	-	-

Approach	EB	NB	SB
HCM Control Delay, s	11.2	0	0
HCM LOS	B		

Minor Lane/Major Mvmt	NBT	EBLn1	SBT	SBR
Capacity (veh/h)	-	588	-	-
HCM Lane V/C Ratio	-	0.005	-	-
HCM Control Delay (s)	-	11.2	-	-
HCM Lane LOS	-	B	-	-
HCM 95th %tile Q(veh)	-	0	-	-

Intersection												
Int Delay, s/veh	2.7											
Movement	EBL	EBT	EBR	WBL	WBT	WBR	NBL	NBT	NBR	SBL	SBT	SBR
Lane Configurations	↙	↑	↗	↙	↗			↕			↕	
Traffic Vol, veh/h	5	130	10	6	179	3	55	0	13	6	0	23
Future Vol, veh/h	5	130	10	6	179	3	55	0	13	6	0	23
Conflicting Peds, #/hr	0	0	0	0	0	0	0	0	0	0	0	0
Sign Control	Free	Free	Free	Free	Free	Free	Stop	Stop	Stop	Stop	Stop	Stop
RT Channelized	-	-	None	-	-	None	-	-	None	-	-	None
Storage Length	150	-	0	150	-	-	-	-	-	-	-	-
Veh in Median Storage, #	-	0	-	-	0	-	-	0	-	-	0	-
Grade, %	-	0	-	-	0	-	-	0	-	-	0	-
Peak Hour Factor	95	95	95	95	95	95	95	95	95	95	95	95
Heavy Vehicles, %	2	2	2	2	2	2	2	2	2	2	2	2
Mvmt Flow	5	137	11	6	188	3	58	0	14	6	0	24

Major/Minor	Major1			Major2			Minor1			Minor2		
Conflicting Flow All	191	0	0	148	0	0	361	350	137	362	360	190
Stage 1	-	-	-	-	-	-	147	147	-	202	202	-
Stage 2	-	-	-	-	-	-	214	203	-	160	158	-
Critical Hdwy	4.12	-	-	4.12	-	-	7.12	6.52	6.22	7.12	6.52	6.22
Critical Hdwy Stg 1	-	-	-	-	-	-	6.12	5.52	-	6.12	5.52	-
Critical Hdwy Stg 2	-	-	-	-	-	-	6.12	5.52	-	6.12	5.52	-
Follow-up Hdwy	2.218	-	-	2.218	-	-	3.518	4.018	3.318	3.518	4.018	3.318
Pot Cap-1 Maneuver	1383	-	-	1434	-	-	595	574	911	594	567	852
Stage 1	-	-	-	-	-	-	856	775	-	800	734	-
Stage 2	-	-	-	-	-	-	788	733	-	842	767	-
Platoon blocked, %	-	-	-	-	-	-	-	-	-	-	-	-
Mov Cap-1 Maneuver	1383	-	-	1434	-	-	575	569	911	582	562	852
Mov Cap-2 Maneuver	-	-	-	-	-	-	575	569	-	582	562	-
Stage 1	-	-	-	-	-	-	853	772	-	797	731	-
Stage 2	-	-	-	-	-	-	762	730	-	826	764	-

Approach	EB			WB			NB			SB		
HCM Control Delay, s	0.3			0.2			11.6			9.8		
HCM LOS							B			A		

Minor Lane/Major Mvmt	NBLn1	EBL	EBT	EBR	WBL	WBT	WBR	SBLn1
Capacity (veh/h)	619	1383	-	-	1434	-	-	777
HCM Lane V/C Ratio	0.116	0.004	-	-	0.004	-	-	0.039
HCM Control Delay (s)	11.6	7.6	-	-	7.5	-	-	9.8
HCM Lane LOS	B	A	-	-	A	-	-	A
HCM 95th %tile Q(veh)	0.4	0	-	-	0	-	-	0.1

Intersection												
Int Delay, s/veh	3.9											
Movement	EBL	EBT	EBR	WBL	WBT	WBR	NBL	NBT	NBR	SBL	SBT	SBR
Lane Configurations	↖	↗		↖	↗			↕			↕	
Traffic Vol, veh/h	3	140	6	16	120	5	48	0	63	11	0	20
Future Vol, veh/h	3	140	6	16	120	5	48	0	63	11	0	20
Conflicting Peds, #/hr	0	0	0	0	0	0	0	0	0	0	0	0
Sign Control	Free	Free	Free	Free	Free	Free	Stop	Stop	Stop	Stop	Stop	Stop
RT Channelized	-	-	None	-	-	None	-	-	None	-	-	None
Storage Length	150	-	-	150	-	-	-	-	-	-	-	-
Veh in Median Storage, #	-	0	-	-	0	-	-	0	-	-	0	-
Grade, %	-	0	-	-	0	-	-	0	-	-	0	-
Peak Hour Factor	95	95	95	95	95	95	95	95	95	95	95	95
Heavy Vehicles, %	2	2	2	2	2	2	2	2	2	2	2	2
Mvmt Flow	3	147	6	17	126	5	51	0	66	12	0	21

Major/Minor	Major1			Major2			Minor1			Minor2		
Conflicting Flow All	131	0	0	153	0	0	329	321	150	352	322	129
Stage 1	-	-	-	-	-	-	156	156	-	163	163	-
Stage 2	-	-	-	-	-	-	173	165	-	189	159	-
Critical Hdwy	4.12	-	-	4.12	-	-	7.12	6.52	6.22	7.12	6.52	6.22
Critical Hdwy Stg 1	-	-	-	-	-	-	6.12	5.52	-	6.12	5.52	-
Critical Hdwy Stg 2	-	-	-	-	-	-	6.12	5.52	-	6.12	5.52	-
Follow-up Hdwy	2.218	-	-	2.218	-	-	3.518	4.018	3.318	3.518	4.018	3.318
Pot Cap-1 Maneuver	1454	-	-	1428	-	-	624	596	896	603	595	921
Stage 1	-	-	-	-	-	-	846	769	-	839	763	-
Stage 2	-	-	-	-	-	-	829	762	-	813	766	-
Platoon blocked, %	-	-	-	-	-	-	-	-	-	-	-	-
Mov Cap-1 Maneuver	1454	-	-	1428	-	-	603	588	896	552	587	921
Mov Cap-2 Maneuver	-	-	-	-	-	-	603	588	-	552	587	-
Stage 1	-	-	-	-	-	-	844	767	-	837	754	-
Stage 2	-	-	-	-	-	-	800	753	-	751	764	-

Approach	EB			WB			NB			SB		
HCM Control Delay, s	0.2			0.9			10.8			10.1		
HCM LOS							B			B		

Minor Lane/Major Mvmt	NBLn1	EBL	EBT	EBR	WBL	WBT	WBR	SBLn1
Capacity (veh/h)	740	1454	-	-	1428	-	-	744
HCM Lane V/C Ratio	0.158	0.002	-	-	0.012	-	-	0.044
HCM Control Delay (s)	10.8	7.5	-	-	7.6	-	-	10.1
HCM Lane LOS	B	A	-	-	A	-	-	B
HCM 95th %tile Q(veh)	0.6	0	-	-	0	-	-	0.1

Intersection												
Int Delay, s/veh	0.2											
Movement	EBL	EBT	EBR	WBL	WBT	WBR	NBL	NBT	NBR	SBL	SBT	SBR
Lane Configurations	↙	↑	↗	↙	↗				↗			↗
Traffic Vol, veh/h	0	406	44	4	453	0	0	0	11	0	0	3
Future Vol, veh/h	0	406	44	4	453	0	0	0	11	0	0	3
Conflicting Peds, #/hr	0	0	0	0	0	0	0	0	0	0	0	0
Sign Control	Free	Free	Free	Free	Free	Free	Stop	Stop	Stop	Stop	Stop	Stop
RT Channelized	-	-	None	-	-	None	-	-	None	-	-	None
Storage Length	150	-	0	150	-	-	-	-	0	-	-	0
Veh in Median Storage, #	-	0	-	-	0	-	-	0	-	-	0	-
Grade, %	-	0	-	-	0	-	-	0	-	-	0	-
Peak Hour Factor	95	95	95	95	95	95	95	95	95	95	95	95
Heavy Vehicles, %	2	2	2	2	2	2	2	2	2	2	2	2
Mvmt Flow	0	427	46	4	477	0	0	0	12	0	0	3

Major/Minor	Major1			Major2			Minor1			Minor2		
Conflicting Flow All	477	0	0	473	0	0	-	-	427	-	-	477
Stage 1	-	-	-	-	-	-	-	-	-	-	-	-
Stage 2	-	-	-	-	-	-	-	-	-	-	-	-
Critical Hdwy	4.12	-	-	4.12	-	-	-	-	6.22	-	-	6.22
Critical Hdwy Stg 1	-	-	-	-	-	-	-	-	-	-	-	-
Critical Hdwy Stg 2	-	-	-	-	-	-	-	-	-	-	-	-
Follow-up Hdwy	2.218	-	-	2.218	-	-	-	-	3.318	-	-	3.318
Pot Cap-1 Maneuver	1085	-	-	1089	-	-	0	0	628	0	0	588
Stage 1	-	-	-	-	-	-	0	0	-	0	0	-
Stage 2	-	-	-	-	-	-	0	0	-	0	0	-
Platoon blocked, %	-	-	-	-	-	-	-	-	-	-	-	-
Mov Cap-1 Maneuver	1085	-	-	1089	-	-	-	-	628	-	-	588
Mov Cap-2 Maneuver	-	-	-	-	-	-	-	-	-	-	-	-
Stage 1	-	-	-	-	-	-	-	-	-	-	-	-
Stage 2	-	-	-	-	-	-	-	-	-	-	-	-

Approach	EB			WB			NB			SB		
HCM Control Delay, s	0			0.1			10.8			11.2		
HCM LOS							B			B		

Minor Lane/Major Mvmt	NBLn1	EBL	EBT	EBR	WBL	WBT	WBR	SBLn1
Capacity (veh/h)	628	1085	-	-	1089	-	-	588
HCM Lane V/C Ratio	0.018	-	-	-	0.004	-	-	0.005
HCM Control Delay (s)	10.8	0	-	-	8.3	-	-	11.2
HCM Lane LOS	B	A	-	-	A	-	-	B
HCM 95th %tile Q(veh)	0.1	0	-	-	0	-	-	0

Intersection												
Int Delay, s/veh	3.1											
Movement	EBL	EBT	EBR	WBL	WBT	WBR	NBL	NBT	NBR	SBL	SBT	SBR
Lane Configurations	↖	↗		↖	↗			↕			↕	
Traffic Vol, veh/h	1	406	10	17	395	24	56	7	18	41	3	7
Future Vol, veh/h	1	406	10	17	395	24	56	7	18	41	3	7
Conflicting Peds, #/hr	0	0	0	0	0	0	0	0	0	0	0	0
Sign Control	Free	Free	Free	Free	Free	Free	Stop	Stop	Stop	Stop	Stop	Stop
RT Channelized	-	-	None	-	-	None	-	-	None	-	-	None
Storage Length	0	-	-	0	-	-	-	-	-	-	-	-
Veh in Median Storage, #	-	0	-	-	0	-	-	0	-	-	0	-
Grade, %	-	0	-	-	0	-	-	0	-	-	0	-
Peak Hour Factor	95	95	95	95	95	95	95	95	95	95	95	95
Heavy Vehicles, %	2	2	2	2	2	2	2	2	2	2	2	2
Mvmt Flow	1	427	11	18	416	25	59	7	19	43	3	7

Major/Minor	Major1			Major2			Minor1			Minor2		
Conflicting Flow All	441	0	0	438	0	0	905	912	433	913	905	429
Stage 1	-	-	-	-	-	-	435	435	-	465	465	-
Stage 2	-	-	-	-	-	-	470	477	-	448	440	-
Critical Hdwy	4.12	-	-	4.12	-	-	7.12	6.52	6.22	7.12	6.52	6.22
Critical Hdwy Stg 1	-	-	-	-	-	-	6.12	5.52	-	6.12	5.52	-
Critical Hdwy Stg 2	-	-	-	-	-	-	6.12	5.52	-	6.12	5.52	-
Follow-up Hdwy	2.218	-	-	2.218	-	-	3.518	4.018	3.318	3.518	4.018	3.318
Pot Cap-1 Maneuver	1119	-	-	1122	-	-	257	274	623	254	276	626
Stage 1	-	-	-	-	-	-	600	580	-	578	563	-
Stage 2	-	-	-	-	-	-	574	556	-	590	578	-
Platoon blocked, %	-	-	-	-	-	-	-	-	-	-	-	-
Mov Cap-1 Maneuver	1119	-	-	1122	-	-	249	269	623	238	271	626
Mov Cap-2 Maneuver	-	-	-	-	-	-	249	269	-	238	271	-
Stage 1	-	-	-	-	-	-	599	579	-	577	554	-
Stage 2	-	-	-	-	-	-	555	547	-	564	577	-

Approach	EB			WB			NB			SB		
HCM Control Delay, s	0			0.3			22.6			22.2		
HCM LOS							C			C		

Minor Lane/Major Mvmt	NBLn1	EBL	EBT	EBR	WBL	WBT	WBR	SBLn1
Capacity (veh/h)	289	1119	-	-	1122	-	-	262
HCM Lane V/C Ratio	0.295	0.001	-	-	0.016	-	-	0.205
HCM Control Delay (s)	22.6	8.2	-	-	8.3	-	-	22.2
HCM Lane LOS	C	A	-	-	A	-	-	C
HCM 95th %tile Q(veh)	1.2	0	-	-	0	-	-	0.8

Intersection

Int Delay, s/veh 323.8

Movement	EBL	EBT	EBR	WBL	WBT	WBR	NBL	NBT	NBR	SBL	SBT	SBR
Lane Configurations	↖	↗		↖	↗	↖	↖	↗	↖	↖	↗	↖
Traffic Vol, veh/h	37	20	12	53	17	115	2	1288	52	75	1092	7
Future Vol, veh/h	37	20	12	53	17	115	2	1288	52	75	1092	7
Conflicting Peds, #/hr	0	0	0	0	0	0	0	0	0	0	0	0
Sign Control	Stop	Stop	Stop	Stop	Stop	Stop	Free	Free	Free	Free	Free	Free
RT Channelized	-	-	None	-	-	None	-	-	None	-	-	None
Storage Length	0	-	-	0	-	150	150	-	150	150	-	150
Veh in Median Storage, #	-	0	-	-	0	-	-	0	-	-	0	-
Grade, %	-	0	-	-	0	-	-	0	-	-	0	-
Peak Hour Factor	95	95	95	95	95	95	95	95	95	95	95	95
Heavy Vehicles, %	2	2	2	2	2	2	2	2	2	2	2	2
Mvmt Flow	39	21	13	56	18	121	2	1356	55	79	1149	7

Major/Minor	Minor2		Minor1		Major1		Major2					
Conflicting Flow All	1998	2722	575	2103	2674	678	1156	0	0	1411	0	0
Stage 1	1307	1307	-	1360	1360	-	-	-	-	-	-	-
Stage 2	691	1415	-	743	1314	-	-	-	-	-	-	-
Critical Hdwy	7.54	6.54	6.94	7.54	6.54	6.94	4.14	-	-	4.14	-	-
Critical Hdwy Stg 1	6.54	5.54	-	6.54	5.54	-	-	-	-	-	-	-
Critical Hdwy Stg 2	6.54	5.54	-	6.54	5.54	-	-	-	-	-	-	-
Follow-up Hdwy	3.52	4.02	3.32	3.52	4.02	3.32	2.22	-	-	2.22	-	-
Pot Cap-1 Maneuver	~ 35	~ 20	461	~ 29	22	395	600	-	-	479	-	-
Stage 1	169	228	-	156	215	-	-	-	-	-	-	-
Stage 2	401	202	-	373	226	-	-	-	-	-	-	-
Platoon blocked, %								-	-	-	-	-
Mov Cap-1 Maneuver	~ 1	~ 17	461	-	18	395	600	-	-	479	-	-
Mov Cap-2 Maneuver	~ 1	~ 17	-	-	18	-	-	-	-	-	-	-
Stage 1	168	190	-	156	214	-	-	-	-	-	-	-
Stage 2	254	201	-	269	189	-	-	-	-	-	-	-

























Approach	EB	WB	NB	SB
HCM Control Delay	\$ 2984.3		0	0.9
HCM LOS	F	-		

Minor Lane/Major Mvmt	NBL	NBT	NBR	EBLn1	EBLn2	WBLn1	WBLn2	WBLn3	SBL	SBT	SBR
Capacity (veh/h)	600	-	-	1	27	-	18	395	479	-	-
HCM Lane V/C Ratio	0.004	-	-	38.947	1.248	-	0.994	0.306	0.165	-	-
HCM Control Delay (s)	11	-	-	\$ 23804.8	\$ 473.2	-	\$ 502.8	18.1	14	-	-
HCM Lane LOS	B	-	-	F	F	-	F	C	B	-	-
HCM 95th %tile Q(veh)	0	-	-	6.9	4	-	2.6	1.3	0.6	-	-

Notes
 -: Volume exceeds capacity \$: Delay exceeds 300s +: Computation Not Defined *: All major volume in platoon

HCM 6th Signalized Intersection Summary
 2: Crowfoot Valley Rd/Motsenbocker Rd & Stroh Rd

2037 Total Traffic
 PM Peak Hour

												
Movement	EBL	EBT	EBR	WBL	WBT	WBR	NBL	NBT	NBR	SBL	SBT	SBR
Lane Configurations												
Traffic Volume (veh/h)	145	490	95	955	465	250	290	322	825	270	520	225
Future Volume (veh/h)	145	490	95	955	465	250	290	322	825	270	520	225
Initial Q (Qb), veh	0	0	0	0	0	0	0	0	0	0	0	0
Ped-Bike Adj(A_pbT)	1.00		1.00	1.00		1.00	1.00		1.00	1.00		1.00
Parking Bus, Adj	1.00	1.00	1.00	1.00	1.00	1.00	1.00	1.00	1.00	1.00	1.00	1.00
Work Zone On Approach		No			No			No			No	
Adj Sat Flow, veh/h/ln	1870	1870	1870	1870	1870	1870	1870	1870	1870	1870	1870	1870
Adj Flow Rate, veh/h	153	516	100	1005	489	263	305	339	868	284	547	237
Peak Hour Factor	0.95	0.95	0.95	0.95	0.95	0.95	0.95	0.95	0.95	0.95	0.95	0.95
Percent Heavy Veh, %	2	2	2	2	2	2	2	2	2	2	2	2
Cap, veh/h	347	620	276	1037	1330	593	391	1187	992	301	1021	456
Arrive On Green	0.09	0.17	0.17	0.30	0.37	0.37	0.11	0.33	0.33	0.07	0.29	0.29
Sat Flow, veh/h	1781	3554	1585	3456	3554	1585	3456	3554	1585	1781	3554	1585
Grp Volume(v), veh/h	153	516	100	1005	489	263	305	339	868	284	547	237
Grp Sat Flow(s),veh/h/ln	1781	1777	1585	1728	1777	1585	1728	1777	1585	1781	1777	1585
Q Serve(g_s), s	8.3	16.8	6.7	34.4	12.0	14.9	10.3	8.4	40.1	8.0	15.6	15.0
Cycle Q Clear(g_c), s	8.3	16.8	6.7	34.4	12.0	14.9	10.3	8.4	40.1	8.0	15.6	15.0
Prop In Lane	1.00		1.00	1.00		1.00	1.00		1.00	1.00		1.00
Lane Grp Cap(c), veh/h	347	620	276	1037	1330	593	391	1187	992	301	1021	456
V/C Ratio(X)	0.44	0.83	0.36	0.97	0.37	0.44	0.78	0.29	0.88	0.94	0.54	0.52
Avail Cap(c_a), veh/h	347	681	304	1037	1392	621	461	1187	992	301	1021	456
HCM Platoon Ratio	1.00	1.00	1.00	1.00	1.00	1.00	1.00	1.00	1.00	1.00	1.00	1.00
Upstream Filter(I)	1.00	1.00	1.00	1.00	1.00	1.00	1.00	1.00	1.00	1.00	1.00	1.00
Uniform Delay (d), s/veh	35.4	47.8	43.7	41.5	27.2	28.2	51.7	29.4	18.6	37.1	36.0	35.8
Incr Delay (d2), s/veh	0.9	8.1	0.8	20.8	0.2	0.5	7.1	0.6	10.7	37.1	2.0	4.2
Initial Q Delay(d3),s/veh	0.0	0.0	0.0	0.0	0.0	0.0	0.0	0.0	0.0	0.0	0.0	0.0
%ile BackOfQ(50%),veh/ln	3.6	8.0	2.6	17.2	5.0	5.6	4.8	3.7	20.5	7.7	7.0	6.2
Unsig. Movement Delay, s/veh												
LnGrp Delay(d),s/veh	36.2	55.9	44.5	62.3	27.4	28.7	58.9	30.0	29.3	74.2	38.0	40.0
LnGrp LOS	D	E	D	E	C	C	E	C	C	E	D	D
Approach Vol, veh/h		769			1757			1512			1068	
Approach Delay, s/veh		50.5			47.6			35.4			48.1	
Approach LOS		D			D			D			D	
Timer - Assigned Phs	1	2	3	4	5	6	7	8				
Phs Duration (G+Y+Rc), s	12.0	44.1	39.0	24.9	17.6	38.5	15.0	48.9				
Change Period (Y+Rc), s	5.0	5.0	5.0	5.0	5.0	5.0	5.0	5.0				
Max Green Setting (Gmax), s	7.0	37.0	34.0	22.0	15.0	29.0	10.0	46.0				
Max Q Clear Time (g_c+I1), s	10.0	42.1	36.4	18.8	12.3	17.6	10.3	16.9				
Green Ext Time (p_c), s	0.0	0.0	0.0	1.1	0.3	3.4	0.0	4.2				
Intersection Summary												
HCM 6th Ctrl Delay			44.5									
HCM 6th LOS			D									

HCM 6th Signalized Intersection Summary
 3: Crowfoot Valley Rd & Chambers Rd/Bayou Gulch Rd

2037 Total Traffic
 PM Peak Hour



Movement	EBL	EBT	EBR	WBL	WBT	WBR	NBL	NBT	NBR	SBL	SBT	SBR
Lane Configurations	↖↗	↑↑	↖	↖↗	↑↑	↖	↖↗	↑↑	↖	↖↗	↑↑	↖
Traffic Volume (veh/h)	205	999	1132	25	1036	481	958	781	24	621	841	120
Future Volume (veh/h)	205	999	1132	25	1036	481	958	781	24	621	841	120
Initial Q (Qb), veh	0	0	0	0	0	0	0	0	0	0	0	0
Ped-Bike Adj(A_pbT)	1.00		1.00	1.00		1.00	1.00		1.00	1.00		1.00
Parking Bus, Adj	1.00	1.00	1.00	1.00	1.00	1.00	1.00	1.00	1.00	1.00	1.00	1.00
Work Zone On Approach		No			No			No			No	
Adj Sat Flow, veh/h/ln	1870	1870	1870	1870	1870	1870	1870	1870	1870	1870	1870	1870
Adj Flow Rate, veh/h	216	1052	1132	26	1091	0	958	822	25	654	885	126
Peak Hour Factor	0.95	0.95	1.00	0.95	0.95	0.95	1.00	0.95	0.95	0.95	0.95	0.95
Percent Heavy Veh, %	2	2	2	2	2	2	2	2	2	2	2	2
Cap, veh/h	259	1125	964	202	1096		979	1097	489	748	888	396
Arrive On Green	0.08	0.32	0.32	0.02	0.10	0.00	0.47	0.52	0.52	0.22	0.25	0.25
Sat Flow, veh/h	3456	3554	1585	3456	3554	1585	3456	3554	1585	3456	3554	1585
Grp Volume(v), veh/h	216	1052	1132	26	1091	0	958	822	25	654	885	126
Grp Sat Flow(s),veh/h/ln	1728	1777	1585	1728	1777	1585	1728	1777	1585	1728	1777	1585
Q Serve(g_s), s	7.4	34.5	39.0	0.9	36.8	0.0	32.6	21.9	0.9	22.0	29.8	7.8
Cycle Q Clear(g_c), s	7.4	34.5	39.0	0.9	36.8	0.0	32.6	21.9	0.9	22.0	29.8	7.8
Prop In Lane	1.00		1.00	1.00		1.00	1.00		1.00	1.00		1.00
Lane Grp Cap(c), veh/h	259	1125	964	202	1096		979	1097	489	748	888	396
V/C Ratio(X)	0.83	0.93	1.17	0.13	1.00		0.98	0.75	0.05	0.87	1.00	0.32
Avail Cap(c_a), veh/h	259	1125	964	259	1096		979	1097	489	749	888	396
HCM Platoon Ratio	1.00	1.00	1.00	0.33	0.33	0.33	1.67	1.67	1.67	1.00	1.00	1.00
Upstream Filter(I)	1.00	1.00	1.00	1.00	1.00	0.00	0.51	0.51	0.51	1.00	1.00	1.00
Uniform Delay (d), s/veh	54.8	39.8	23.5	55.8	53.8	0.0	31.3	25.4	20.3	45.4	44.9	36.7
Incr Delay (d2), s/veh	20.2	14.0	89.3	0.3	26.1	0.0	15.7	2.5	0.1	11.2	29.3	2.1
Initial Q Delay(d3),s/veh	0.0	0.0	0.0	0.0	0.0	0.0	0.0	0.0	0.0	0.0	0.0	0.0
%ile BackOfQ(50%),veh/ln	8.9	17.0	48.9	0.4	21.6	0.0	13.5	7.9	0.4	10.5	16.6	3.3
Unsig. Movement Delay, s/veh												
LnGrp Delay(d),s/veh	75.0	53.8	112.8	56.1	79.9	0.0	46.9	27.9	20.4	56.7	74.2	38.8
LnGrp LOS	E	D	F	E	E		D	C	C	E	E	D
Approach Vol, veh/h		2400			1117	A		1805			1665	
Approach Delay, s/veh		83.5			79.3			37.9			64.6	
Approach LOS		F			E			D			E	
Timer - Assigned Phs	1	2	3	4	5	6	7	8				
Phs Duration (G+Y+Rc), s	39.0	40.0	10.0	41.0	36.0	33.0	12.0	39.0				
Change Period (Y+Rc), s	5.0	5.0	5.0	5.0	5.0	5.0	5.0	5.0				
Max Green Setting (Gmax), s	24.0	35.0	7.0	34.0	31.0	28.0	7.0	34.0				
Max Q Clear Time (g_c+24.0), s	24.0	23.9	2.9	41.0	34.6	31.8	9.4	38.8				
Green Ext Time (p_c), s	0.0	4.4	0.0	0.0	0.0	0.0	0.0	0.0				

Intersection Summary

HCM 6th Ctrl Delay	66.6
HCM 6th LOS	E

Notes

Unsignalized Delay for [WBR] is excluded from calculations of the approach delay and intersection delay.

HCM 6th Signalized Intersection Summary

4: Crowfoot Valley Rd & Pinery Pkwy

2037 Total Traffic
PM Peak Hour



Movement	WBL	WBR	NBT	NBR	SBL	SBT
Lane Configurations						
Traffic Volume (veh/h)	238	86	1685	237	136	1875
Future Volume (veh/h)	238	86	1685	237	136	1875
Initial Q (Qb), veh	0	0	0	0	0	0
Ped-Bike Adj(A_pbT)	1.00	1.00		1.00	1.00	
Parking Bus, Adj	1.00	1.00	1.00	1.00	1.00	1.00
Work Zone On Approach	No		No		No	
Adj Sat Flow, veh/h/ln	1870	1870	1870	1870	1870	1870
Adj Flow Rate, veh/h	251	0	1774	249	143	1974
Peak Hour Factor	0.95	0.95	0.95	0.95	0.95	0.95
Percent Heavy Veh, %	2	2	2	2	2	2
Cap, veh/h	283		2395	1068	208	2693
Arrive On Green	0.16	0.00	0.67	0.67	0.08	1.00
Sat Flow, veh/h	1781	1585	3647	1585	1781	3647
Grp Volume(v), veh/h	251	0	1774	249	143	1974
Grp Sat Flow(s),veh/h/ln	1781	1585	1777	1585	1781	1777
Q Serve(g_s), s	16.6	0.0	39.0	7.3	2.9	0.0
Cycle Q Clear(g_c), s	16.6	0.0	39.0	7.3	2.9	0.0
Prop In Lane	1.00	1.00		1.00	1.00	
Lane Grp Cap(c), veh/h	283		2395	1068	208	2693
V/C Ratio(X)	0.89		0.74	0.23	0.69	0.73
Avail Cap(c_a), veh/h	445		2395	1068	282	2693
HCM Platoon Ratio	1.00	1.00	1.00	1.00	2.00	2.00
Upstream Filter(I)	1.00	0.00	1.00	1.00	0.09	0.09
Uniform Delay (d), s/veh	49.4	0.0	12.7	7.6	21.1	0.0
Incr Delay (d2), s/veh	12.6	0.0	2.1	0.5	0.4	0.2
Initial Q Delay(d3),s/veh	0.0	0.0	0.0	0.0	0.0	0.0
%ile BackOfQ(50%),veh/ln	8.2	0.0	14.9	2.5	2.8	0.1
Unsig. Movement Delay, s/veh						
LnGrp Delay(d),s/veh	62.0	0.0	14.8	8.1	21.5	0.2
LnGrp LOS	E		B	A	C	A
Approach Vol, veh/h	251	A	2023			2117
Approach Delay, s/veh	62.0		14.0			1.6
Approach LOS	E		B			A
Timer - Assigned Phs	1	2			6	8
Phs Duration (G+Y+Rc), s	10.0	85.9			95.9	24.1
Change Period (Y+Rc), s	5.0	5.0			5.0	5.0
Max Green Setting (Gmax), s	10.0	65.0			80.0	30.0
Max Q Clear Time (g_c+1), s	11.0	41.0			2.0	18.6
Green Ext Time (p_c), s	0.1	16.7			35.7	0.5

Intersection Summary

HCM 6th Ctrl Delay		10.8
HCM 6th LOS		B

Notes

Unsignalized Delay for [WBR] is excluded from calculations of the approach delay and intersection delay.

HCM 6th Signalized Intersection Summary

5: Crowfoot Valley Rd & Pradera Pkwy

2037 Total Traffic
PM Peak Hour



Movement	WBL	WBR	NBT	NBR	SBL	SBT
Lane Configurations						
Traffic Volume (veh/h)	98	41	1753	144	66	1892
Future Volume (veh/h)	98	41	1753	144	66	1892
Initial Q (Qb), veh	0	0	0	0	0	0
Ped-Bike Adj(A_pbT)	1.00	1.00		1.00	1.00	
Parking Bus, Adj	1.00	1.00	1.00	1.00	1.00	1.00
Work Zone On Approach	No		No		No	
Adj Sat Flow, veh/h/ln	1870	1870	1870	1870	1870	1870
Adj Flow Rate, veh/h	103	43	1845	152	69	1992
Peak Hour Factor	0.95	0.95	0.95	0.95	0.95	0.95
Percent Heavy Veh, %	2	2	2	2	2	2
Cap, veh/h	134	120	2708	1208	236	2989
Arrive On Green	0.08	0.08	0.76	0.76	0.04	0.84
Sat Flow, veh/h	1781	1585	3647	1585	1781	3647
Grp Volume(v), veh/h	103	43	1845	152	69	1992
Grp Sat Flow(s),veh/h/ln	1781	1585	1777	1585	1781	1777
Q Serve(g_s), s	6.8	3.1	30.8	3.0	0.9	24.3
Cycle Q Clear(g_c), s	6.8	3.1	30.8	3.0	0.9	24.3
Prop In Lane	1.00	1.00		1.00	1.00	
Lane Grp Cap(c), veh/h	134	120	2708	1208	236	2989
V/C Ratio(X)	0.77	0.36	0.68	0.13	0.29	0.67
Avail Cap(c_a), veh/h	371	330	2708	1208	318	2989
HCM Platoon Ratio	1.00	1.00	1.00	1.00	1.00	1.00
Upstream Filter(I)	1.00	1.00	1.00	1.00	1.00	1.00
Uniform Delay (d), s/veh	54.4	52.7	7.1	3.8	8.7	3.4
Incr Delay (d2), s/veh	8.7	1.8	1.4	0.2	0.7	1.2
Initial Q Delay(d3),s/veh	0.0	0.0	0.0	0.0	0.0	0.0
%ile BackOfQ(50%),veh/ln	3.3	1.3	8.5	0.8	0.6	3.9
Unsig. Movement Delay, s/veh						
LnGrp Delay(d),s/veh	63.2	54.5	8.5	4.0	9.4	4.6
LnGrp LOS	E	D	A	A	A	A
Approach Vol, veh/h	146		1997			2061
Approach Delay, s/veh	60.6		8.1			4.8
Approach LOS	E		A			A
Timer - Assigned Phs	1	2			6	8
Phs Duration (G+Y+Rc), s	9.5	96.4			105.9	14.1
Change Period (Y+Rc), s	5.0	5.0			5.0	5.0
Max Green Setting (Gmax), s	70.0	70.0			85.0	25.0
Max Q Clear Time (g_c+I), s	32.8	32.8			26.3	8.8
Green Ext Time (p_c), s	0.1	20.0			26.7	0.3

Intersection Summary

HCM 6th Ctrl Delay		8.3				
HCM 6th LOS			A			

HCM 6th Signalized Intersection Summary
 7: Parker Rd & Pinery Pkwy

2037 Total Traffic
 PM Peak Hour



Movement	EBL	EBT	EBR	WBL	WBT	WBR	NBL	NBT	NBR	SBL	SBT	SBR
Lane Configurations	↔↔	↑	↔	↔	↔		↔	↑↑↑		↔↔	↑↑↑	↔
Traffic Volume (veh/h)	121	125	178	50	50	200	80	1175	35	420	1975	183
Future Volume (veh/h)	121	125	178	50	50	200	80	1175	35	420	1975	183
Initial Q (Qb), veh	0	0	0	0	0	0	0	0	0	0	0	0
Ped-Bike Adj(A_pbT)	1.00		1.00	1.00		1.00	1.00		1.00	1.00		1.00
Parking Bus, Adj	1.00	1.00	1.00	1.00	1.00	1.00	1.00	1.00	1.00	1.00	1.00	1.00
Work Zone On Approach		No			No			No			No	
Adj Sat Flow, veh/h/ln	1870	1870	1870	1870	1870	1870	1870	1870	1870	1870	1870	1870
Adj Flow Rate, veh/h	127	132	0	53	53	211	84	1237	37	442	2079	0
Peak Hour Factor	0.95	0.95	0.95	0.95	0.95	0.95	0.95	0.95	0.95	0.95	0.95	0.95
Percent Heavy Veh, %	2	2	2	2	2	2	2	2	2	2	2	2
Cap, veh/h	210	383		318	61	244	120	2369	71	475	2689	
Arrive On Green	0.06	0.20	0.00	0.04	0.19	0.19	0.07	0.46	0.46	0.14	0.53	0.00
Sat Flow, veh/h	3456	1870	1585	1781	328	1307	1781	5095	152	3456	5106	1585
Grp Volume(v), veh/h	127	132	0	53	0	264	84	826	448	442	2079	0
Grp Sat Flow(s),veh/h/ln	1728	1870	1585	1781	0	1635	1781	1702	1843	1728	1702	1585
Q Serve(g_s), s	4.3	7.2	0.0	2.8	0.0	18.8	5.5	20.6	20.6	15.2	39.0	0.0
Cycle Q Clear(g_c), s	4.3	7.2	0.0	2.8	0.0	18.8	5.5	20.6	20.6	15.2	39.0	0.0
Prop In Lane	1.00		1.00	1.00		0.80	1.00		0.08	1.00		1.00
Lane Grp Cap(c), veh/h	210	383		318	0	305	120	1583	857	475	2689	
V/C Ratio(X)	0.60	0.34		0.17	0.00	0.86	0.70	0.52	0.52	0.93	0.77	
Avail Cap(c_a), veh/h	302	405		397	0	354	156	1583	857	475	2689	
HCM Platoon Ratio	1.00	1.00	1.00	1.00	1.00	1.00	1.00	1.00	1.00	1.00	1.00	1.00
Upstream Filter(I)	1.00	1.00	0.00	1.00	0.00	1.00	1.00	1.00	1.00	1.00	1.00	0.00
Uniform Delay (d), s/veh	54.9	40.8	0.0	36.8	0.0	47.3	54.8	22.7	22.7	51.2	22.7	0.0
Incr Delay (d2), s/veh	2.8	0.5	0.0	0.2	0.0	17.6	9.0	1.2	2.3	25.0	2.2	0.0
Initial Q Delay(d3),s/veh	0.0	0.0	0.0	0.0	0.0	0.0	0.0	0.0	0.0	0.0	0.0	0.0
%ile BackOfQ(50%),veh/ln	2.0	3.4	0.0	1.3	0.0	9.2	2.7	7.8	8.7	7.9	14.3	0.0
Unsig. Movement Delay, s/veh												
LnGrp Delay(d),s/veh	57.7	41.4	0.0	37.1	0.0	64.9	63.8	23.9	25.0	76.2	24.9	0.0
LnGrp LOS	E	D		D	A	E	E	C	C	E	C	
Approach Vol, veh/h		259	A		317			1358			2521	A
Approach Delay, s/veh		49.4			60.3			26.7			33.9	
Approach LOS		D			E			C			C	
Timer - Assigned Phs	1	2	3	4	5	6	7	8				
Phs Duration (G+Y+Rc), s	30.0	61.8	9.6	28.6	12.6	69.2	11.8	26.4				
Change Period (Y+Rc), s	5.5	7.0	5.5	5.0	5.5	7.0	5.5	5.0				
Max Green Setting (Gmax), s	41.5	48.0	9.5	25.0	9.5	53.0	9.5	25.0				
Max Q Clear Time (g_c+I), s	17.2	22.6	4.8	9.2	7.5	41.0	6.3	20.8				
Green Ext Time (p_c), s	0.0	8.2	0.0	0.5	0.0	9.2	0.1	0.6				

Intersection Summary

HCM 6th Ctrl Delay	34.5
HCM 6th LOS	C

Notes

Unsignalized Delay for [EBR, SBR] is excluded from calculations of the approach delay and intersection delay.

HCM 6th Signalized Intersection Summary
8: Bayou Gulch Rd & Pinery Pkwy

2037 Total Traffic
PM Peak Hour



Movement	EBL	EBT	EBR	WBL	WBT	WBR	NBL	NBT	NBR	SBL	SBT	SBR
Lane Configurations												
Traffic Volume (veh/h)	161	83	25	47	70	169	19	1164	36	502	835	195
Future Volume (veh/h)	161	83	25	47	70	169	19	1164	36	502	835	195
Initial Q (Qb), veh	0	0	0	0	0	0	0	0	0	0	0	0
Ped-Bike Adj(A_pbT)	1.00		1.00	1.00		1.00	1.00		1.00	1.00		1.00
Parking Bus, Adj	1.00	1.00	1.00	1.00	1.00	1.00	1.00	1.00	1.00	1.00	1.00	1.00
Work Zone On Approach		No			No			No			No	
Adj Sat Flow, veh/h/ln	1870	1870	1870	1870	1870	1870	1870	1870	1870	1870	1870	1870
Adj Flow Rate, veh/h	169	87	26	49	74	178	20	1225	38	528	879	205
Peak Hour Factor	0.95	0.95	0.95	0.95	0.95	0.95	0.95	0.95	0.95	0.95	0.95	0.95
Percent Heavy Veh, %	2	2	2	2	2	2	2	2	2	2	2	2
Cap, veh/h	294	304	258	264	211	456	327	1613	733	605	2193	978
Arrive On Green	0.08	0.16	0.16	0.03	0.11	0.11	0.02	0.45	0.46	0.12	0.41	0.41
Sat Flow, veh/h	1781	1870	1585	1781	1870	1585	1781	3554	1585	3456	3554	1585
Grp Volume(v), veh/h	169	87	26	49	74	178	20	1225	38	528	879	205
Grp Sat Flow(s),veh/h/ln	1781	1870	1585	1781	1870	1585	1781	1777	1585	1728	1777	1585
Q Serve(g_s), s	9.9	4.9	1.7	2.9	4.4	10.8	0.7	34.5	1.6	18.0	20.9	10.0
Cycle Q Clear(g_c), s	9.9	4.9	1.7	2.9	4.4	10.8	0.7	34.5	1.6	18.0	20.9	10.0
Prop In Lane	1.00		1.00	1.00		1.00	1.00		1.00	1.00		1.00
Lane Grp Cap(c), veh/h	294	304	258	264	211	456	327	1613	733	605	2193	978
V/C Ratio(X)	0.57	0.29	0.10	0.19	0.35	0.39	0.06	0.76	0.05	0.87	0.40	0.21
Avail Cap(c_a), veh/h	294	390	330	353	390	608	439	1613	733	720	2193	978
HCM Platoon Ratio	1.00	1.00	1.00	1.00	1.00	1.00	1.00	1.00	1.00	0.67	0.67	0.67
Upstream Filter(I)	1.00	1.00	1.00	1.00	1.00	1.00	1.00	1.00	1.00	1.00	1.00	1.00
Uniform Delay (d), s/veh	41.3	44.1	42.8	45.0	49.2	34.3	16.3	27.3	17.8	51.7	19.6	16.4
Incr Delay (d2), s/veh	2.7	0.5	0.2	0.3	1.0	0.5	0.1	3.4	0.1	10.1	0.5	0.5
Initial Q Delay(d3),s/veh	0.0	0.0	0.0	0.0	0.0	0.0	0.0	0.0	0.0	0.0	0.0	0.0
%ile BackOfQ(50%),veh/ln	4.5	2.3	0.7	1.3	2.1	4.2	0.3	15.1	0.6	8.9	9.5	3.8
Unsig. Movement Delay, s/veh												
LnGrp Delay(d),s/veh	44.0	44.7	43.0	45.3	50.2	34.8	16.3	30.7	17.9	61.8	20.1	16.9
LnGrp LOS	D	D	D	D	D	C	B	C	B	E	C	B
Approach Vol, veh/h		282			301			1283			1612	
Approach Delay, s/veh		44.1			40.3			30.1			33.4	
Approach LOS		D			D			C			C	
Timer - Assigned Phs	1	2	3	4	5	6	7	8				
Phs Duration (G+Y+Rc), s	36.0	60.5	9.0	24.5	7.4	79.0	15.0	18.5				
Change Period (Y+Rc), s	5.0	5.0	5.0	5.0	5.0	5.0	5.0	5.0				
Max Green Setting (Gmax), s	25.0	40.0	10.0	25.0	10.0	55.0	10.0	25.0				
Max Q Clear Time (g_c+20), s	20.0	36.5	4.9	6.9	2.7	22.9	11.9	12.8				
Green Ext Time (p_c), s	1.0	2.5	0.0	0.4	0.0	8.2	0.0	0.7				

Intersection Summary

HCM 6th Ctrl Delay	33.6
HCM 6th LOS	C

HCM 6th TWSC
 25: Bayou Gulch Rd & South Access

2037 Total Traffic
 PM Peak Hour

Intersection

Int Delay, s/veh 0

Movement EBL EBR NBL NBT SBT SBR

Lane Configurations		↗		↑↑	↑↑	
Traffic Vol, veh/h	0	2	0	1202	815	55
Future Vol, veh/h	0	2	0	1202	815	55
Conflicting Peds, #/hr	0	0	0	0	0	0
Sign Control	Stop	Stop	Free	Free	Free	Free
RT Channelized	-	None	-	None	-	None
Storage Length	-	0	-	-	-	-
Veh in Median Storage, #	0	-	-	0	0	-
Grade, %	0	-	-	0	0	-
Peak Hour Factor	95	95	95	95	95	95
Heavy Vehicles, %	2	2	2	2	2	2
Mvmt Flow	0	2	0	1265	858	58

Major/Minor Minor2 Major1 Major2

Conflicting Flow All	-	458	-	0	-	0
Stage 1	-	-	-	-	-	-
Stage 2	-	-	-	-	-	-
Critical Hdwy	-	6.94	-	-	-	-
Critical Hdwy Stg 1	-	-	-	-	-	-
Critical Hdwy Stg 2	-	-	-	-	-	-
Follow-up Hdwy	-	3.32	-	-	-	-
Pot Cap-1 Maneuver	0	550	0	-	-	-
Stage 1	0	-	0	-	-	-
Stage 2	0	-	0	-	-	-
Platoon blocked, %				-	-	-
Mov Cap-1 Maneuver	-	550	-	-	-	-
Mov Cap-2 Maneuver	-	-	-	-	-	-
Stage 1	-	-	-	-	-	-
Stage 2	-	-	-	-	-	-

Approach EB NB SB

HCM Control Delay, s	11.6	0	0
HCM LOS	B		

Minor Lane/Major Mvmt NBT EBLn1 SBT SBR

Capacity (veh/h)	-	550	-	-
HCM Lane V/C Ratio	-	0.004	-	-
HCM Control Delay (s)	-	11.6	-	-
HCM Lane LOS	-	B	-	-
HCM 95th %tile Q(veh)	-	0	-	-

HCM 6th TWSC
41: PA 40 West/PA 34 West & Pinery Pkwy

2037 Total Traffic
PM Peak Hour

Intersection												
Int Delay, s/veh	1.7											
Movement	EBL	EBT	EBR	WBL	WBT	WBR	NBL	NBT	NBR	SBL	SBT	SBR
Lane Configurations	↖	↑	↗	↖	↗			↕			↕	
Traffic Vol, veh/h	30	278	65	10	269	7	38	0	8	4	0	16
Future Vol, veh/h	30	278	65	10	269	7	38	0	8	4	0	16
Conflicting Peds, #/hr	0	0	0	0	0	0	0	0	0	0	0	0
Sign Control	Free	Free	Free	Free	Free	Free	Stop	Stop	Stop	Stop	Stop	Stop
RT Channelized	-	-	None	-	-	None	-	-	None	-	-	None
Storage Length	150	-	0	150	-	-	-	-	-	-	-	-
Veh in Median Storage, #	-	0	-	-	0	-	-	0	-	-	0	-
Grade, %	-	0	-	-	0	-	-	0	-	-	0	-
Peak Hour Factor	95	95	95	95	95	95	95	95	95	95	95	95
Heavy Vehicles, %	2	2	2	2	2	2	2	2	2	2	2	2
Mvmt Flow	32	293	68	11	283	7	40	0	8	4	0	17

Major/Minor	Major1			Major2			Minor1			Minor2		
Conflicting Flow All	290	0	0	361	0	0	674	669	293	704	734	287
Stage 1	-	-	-	-	-	-	357	357	-	309	309	-
Stage 2	-	-	-	-	-	-	317	312	-	395	425	-
Critical Hdwy	4.12	-	-	4.12	-	-	7.12	6.52	6.22	7.12	6.52	6.22
Critical Hdwy Stg 1	-	-	-	-	-	-	6.12	5.52	-	6.12	5.52	-
Critical Hdwy Stg 2	-	-	-	-	-	-	6.12	5.52	-	6.12	5.52	-
Follow-up Hdwy	2.218	-	-	2.218	-	-	3.518	4.018	3.318	3.518	4.018	3.318
Pot Cap-1 Maneuver	1272	-	-	1198	-	-	368	379	746	352	347	752
Stage 1	-	-	-	-	-	-	661	628	-	701	660	-
Stage 2	-	-	-	-	-	-	694	658	-	630	586	-
Platoon blocked, %	-	-	-	-	-	-	-	-	-	-	-	-
Mov Cap-1 Maneuver	1272	-	-	1198	-	-	350	366	746	339	335	752
Mov Cap-2 Maneuver	-	-	-	-	-	-	350	366	-	339	335	-
Stage 1	-	-	-	-	-	-	644	612	-	683	654	-
Stage 2	-	-	-	-	-	-	672	652	-	607	571	-

Approach	EB			WB			NB			SB		
HCM Control Delay, s	0.6			0.3			15.7			11.2		
HCM LOS							C			B		

Minor Lane/Major Mvmt	NBLn1	EBL	EBT	EBR	WBL	WBT	WBR	SBLn1
Capacity (veh/h)	386	1272	-	-	1198	-	-	605
HCM Lane V/C Ratio	0.125	0.025	-	-	0.009	-	-	0.035
HCM Control Delay (s)	15.7	7.9	-	-	8	-	-	11.2
HCM Lane LOS	C	A	-	-	A	-	-	B
HCM 95th %tile Q(veh)	0.4	0.1	-	-	0	-	-	0.1

HCM 6th TWSC
42: PA 40 East/PA 34 East & Pinery Pkwy

2037 Total Traffic
PM Peak Hour

Intersection												
Int Delay, s/veh	2.5											
Movement	EBL	EBT	EBR	WBL	WBT	WBR	NBL	NBT	NBR	SBL	SBT	SBR
Lane Configurations	↖	↗		↖	↗			↕			↕	
Traffic Vol, veh/h	25	224	41	31	240	13	33	0	36	8	0	13
Future Vol, veh/h	25	224	41	31	240	13	33	0	36	8	0	13
Conflicting Peds, #/hr	0	0	0	0	0	0	0	0	0	0	0	0
Sign Control	Free	Free	Free	Free	Free	Free	Stop	Stop	Stop	Stop	Stop	Stop
RT Channelized	-	-	None	-	-	None	-	-	None	-	-	None
Storage Length	150	-	-	150	-	-	-	-	-	-	-	-
Veh in Median Storage, #	-	0	-	-	0	-	-	0	-	-	0	-
Grade, %	-	0	-	-	0	-	-	0	-	-	0	-
Peak Hour Factor	95	95	95	95	95	95	95	95	95	95	95	95
Heavy Vehicles, %	2	2	2	2	2	2	2	2	2	2	2	2
Mvmt Flow	26	236	43	33	253	14	35	0	38	8	0	14

Major/Minor	Major1			Major2			Minor1			Minor2		
Conflicting Flow All	267	0	0	279	0	0	643	643	258	655	657	260
Stage 1	-	-	-	-	-	-	310	310	-	326	326	-
Stage 2	-	-	-	-	-	-	333	333	-	329	331	-
Critical Hdwy	4.12	-	-	4.12	-	-	7.12	6.52	6.22	7.12	6.52	6.22
Critical Hdwy Stg 1	-	-	-	-	-	-	6.12	5.52	-	6.12	5.52	-
Critical Hdwy Stg 2	-	-	-	-	-	-	6.12	5.52	-	6.12	5.52	-
Follow-up Hdwy	2.218	-	-	2.218	-	-	3.518	4.018	3.318	3.518	4.018	3.318
Pot Cap-1 Maneuver	1297	-	-	1284	-	-	386	392	781	379	385	779
Stage 1	-	-	-	-	-	-	700	659	-	687	648	-
Stage 2	-	-	-	-	-	-	681	644	-	684	645	-
Platoon blocked, %	-	-	-	-	-	-	-	-	-	-	-	-
Mov Cap-1 Maneuver	1297	-	-	1284	-	-	366	374	781	348	368	779
Mov Cap-2 Maneuver	-	-	-	-	-	-	366	374	-	348	368	-
Stage 1	-	-	-	-	-	-	686	646	-	673	631	-
Stage 2	-	-	-	-	-	-	652	627	-	638	632	-

Approach	EB			WB			NB			SB		
HCM Control Delay, s	0.7			0.9			13.3			12.1		
HCM LOS							B			B		

Minor Lane/Major Mvmt	NBLn1	EBL	EBT	EBR	WBL	WBT	WBR	SBLn1
Capacity (veh/h)	506	1297	-	-	1284	-	-	529
HCM Lane V/C Ratio	0.144	0.02	-	-	0.025	-	-	0.042
HCM Control Delay (s)	13.3	7.8	-	-	7.9	-	-	12.1
HCM Lane LOS	B	A	-	-	A	-	-	B
HCM 95th %tile Q(veh)	0.5	0.1	-	-	0.1	-	-	0.1

HCM 6th TWSC
 43: Three-Quarter Access & Pinery Pkwy

2037 Total Traffic
 PM Peak Hour

Intersection												
Int Delay, s/veh	0.7											
Movement	EBL	EBT	EBR	WBL	WBT	WBR	NBL	NBT	NBR	SBL	SBT	SBR
Lane Configurations	↙	↑	↗	↙	↗				↗			↗
Traffic Vol, veh/h	2	479	140	9	285	4	0	0	49	0	0	1
Future Vol, veh/h	2	479	140	9	285	4	0	0	49	0	0	1
Conflicting Peds, #/hr	0	0	0	0	0	0	0	0	0	0	0	0
Sign Control	Free	Free	Free	Free	Free	Free	Stop	Stop	Stop	Stop	Stop	Stop
RT Channelized	-	-	None	-	-	None	-	-	None	-	-	None
Storage Length	150	-	0	150	-	-	-	-	0	-	-	0
Veh in Median Storage, #	-	0	-	-	0	-	-	0	-	-	0	-
Grade, %	-	0	-	-	0	-	-	0	-	-	0	-
Peak Hour Factor	95	95	95	95	95	95	95	95	95	95	95	95
Heavy Vehicles, %	2	2	2	2	2	2	2	2	2	2	2	2
Mvmt Flow	2	504	147	9	300	4	0	0	52	0	0	1

Major/Minor	Major1			Major2			Minor1			Minor2		
Conflicting Flow All	304	0	0	651	0	0	-	-	504	-	-	302
Stage 1	-	-	-	-	-	-	-	-	-	-	-	-
Stage 2	-	-	-	-	-	-	-	-	-	-	-	-
Critical Hdwy	4.12	-	-	4.12	-	-	-	-	6.22	-	-	6.22
Critical Hdwy Stg 1	-	-	-	-	-	-	-	-	-	-	-	-
Critical Hdwy Stg 2	-	-	-	-	-	-	-	-	-	-	-	-
Follow-up Hdwy	2.218	-	-	2.218	-	-	-	-	3.318	-	-	3.318
Pot Cap-1 Maneuver	1257	-	-	935	-	-	0	0	568	0	0	738
Stage 1	-	-	-	-	-	-	0	0	-	0	0	-
Stage 2	-	-	-	-	-	-	0	0	-	0	0	-
Platoon blocked, %	-	-	-	-	-	-	-	-	-	-	-	-
Mov Cap-1 Maneuver	1257	-	-	935	-	-	-	-	568	-	-	738
Mov Cap-2 Maneuver	-	-	-	-	-	-	-	-	-	-	-	-
Stage 1	-	-	-	-	-	-	-	-	-	-	-	-
Stage 2	-	-	-	-	-	-	-	-	-	-	-	-

Approach	EB			WB			NB			SB		
HCM Control Delay, s	0			0.3			12			9.9		
HCM LOS							B			A		

Minor Lane/Major Mvmt	NBLn1	EBL	EBT	EBR	WBL	WBT	WBR	SBLn1
Capacity (veh/h)	568	1257	-	-	935	-	-	738
HCM Lane V/C Ratio	0.091	0.002	-	-	0.01	-	-	0.001
HCM Control Delay (s)	12	7.9	-	-	8.9	-	-	9.9
HCM Lane LOS	B	A	-	-	A	-	-	A
HCM 95th %tile Q(veh)	0.3	0	-	-	0	-	-	0

Intersection												
Int Delay, s/veh	6.6											
Movement	EBL	EBT	EBR	WBL	WBT	WBR	NBL	NBT	NBR	SBL	SBT	SBR
Lane Configurations	↖	↗		↖	↗			↕			↕	
Traffic Vol, veh/h	8	499	20	44	153	36	138	7	11	24	1	8
Future Vol, veh/h	8	499	20	44	153	36	138	7	11	24	1	8
Conflicting Peds, #/hr	0	0	0	0	0	0	0	0	0	0	0	0
Sign Control	Free	Free	Free	Free	Free	Free	Stop	Stop	Stop	Stop	Stop	Stop
RT Channelized	-	-	None	-	-	None	-	-	None	-	-	None
Storage Length	0	-	-	0	-	-	-	-	-	-	-	-
Veh in Median Storage, #	-	0	-	-	0	-	-	0	-	-	0	-
Grade, %	-	0	-	-	0	-	-	0	-	-	0	-
Peak Hour Factor	95	95	95	95	95	95	95	95	95	95	95	95
Heavy Vehicles, %	2	2	2	2	2	2	2	2	2	2	2	2
Mvmt Flow	8	525	21	46	161	38	145	7	12	25	1	8

Major/Minor	Major1			Major2			Minor1			Minor2		
Conflicting Flow All	199	0	0	546	0	0	829	843	536	833	834	180
Stage 1	-	-	-	-	-	-	552	552	-	272	272	-
Stage 2	-	-	-	-	-	-	277	291	-	561	562	-
Critical Hdwy	4.12	-	-	4.12	-	-	7.12	6.52	6.22	7.12	6.52	6.22
Critical Hdwy Stg 1	-	-	-	-	-	-	6.12	5.52	-	6.12	5.52	-
Critical Hdwy Stg 2	-	-	-	-	-	-	6.12	5.52	-	6.12	5.52	-
Follow-up Hdwy	2.218	-	-	2.218	-	-	3.518	4.018	3.318	3.518	4.018	3.318
Pot Cap-1 Maneuver	1373	-	-	1023	-	-	290	300	545	288	304	863
Stage 1	-	-	-	-	-	-	518	515	-	734	685	-
Stage 2	-	-	-	-	-	-	729	672	-	512	510	-
Platoon blocked, %	-	-	-	-	-	-	-	-	-	-	-	-
Mov Cap-1 Maneuver	1373	-	-	1023	-	-	275	285	545	266	288	863
Mov Cap-2 Maneuver	-	-	-	-	-	-	275	285	-	266	288	-
Stage 1	-	-	-	-	-	-	515	512	-	730	654	-
Stage 2	-	-	-	-	-	-	688	642	-	491	507	-

Approach	EB			WB			NB			SB		
HCM Control Delay, s	0.1			1.6			33.5			17.6		
HCM LOS							D			C		

Minor Lane/Major Mvmt	NBLn1	EBL	EBT	EBR	WBL	WBT	WBR	SBLn1
Capacity (veh/h)	285	1373	-	-	1023	-	-	320
HCM Lane V/C Ratio	0.576	0.006	-	-	0.045	-	-	0.109
HCM Control Delay (s)	33.5	7.6	-	-	8.7	-	-	17.6
HCM Lane LOS	D	A	-	-	A	-	-	C
HCM 95th %tile Q(veh)	3.3	0	-	-	0.1	-	-	0.4

HCM 6th TWSC
 48: Bayou Gulch Rd & PA-36&37/PA 34&35

2037 Total Traffic
 PM Peak Hour

Intersection												
Int Delay, s/veh	0.5											
Movement	EBL	EBT	EBR	WBL	WBT	WBR	NBL	NBT	NBR	SBL	SBT	SBR
Lane Configurations	↖	↗		↖	↗	↖	↖	↗	↖	↖	↗	↖
Traffic Vol, veh/h	24	6	10	23	6	62	14	1456	24	97	1499	48
Future Vol, veh/h	24	6	10	23	6	62	14	1456	24	97	1499	48
Conflicting Peds, #/hr	0	0	0	0	0	0	0	0	0	0	0	0
Sign Control	Stop	Stop	Stop	Stop	Stop	Stop	Free	Free	Free	Free	Free	Free
RT Channelized	-	-	None	-	-	None	-	-	None	-	-	None
Storage Length	0	-	-	0	-	150	150	-	150	150	-	150
Veh in Median Storage, #	-	0	-	-	0	-	-	0	-	-	0	-
Grade, %	-	0	-	-	0	-	-	0	-	-	0	-
Peak Hour Factor	95	95	95	95	95	95	95	95	95	95	95	95
Heavy Vehicles, %	2	2	2	2	2	2	2	2	2	2	2	2
Mvmt Flow	25	6	11	24	6	65	15	1533	25	102	1578	51

Major/Minor	Minor2		Minor1		Major1		Major2					
Conflicting Flow All	2582	3370	789	2559	3396	767	1629	0	0	1558	0	0
Stage 1	1782	1782	-	1563	1563	-	-	-	-	-	-	-
Stage 2	800	1588	-	996	1833	-	-	-	-	-	-	-
Critical Hdwy	7.54	6.54	6.94	7.54	6.54	6.94	4.14	-	-	4.14	-	-
Critical Hdwy Stg 1	6.54	5.54	-	6.54	5.54	-	-	-	-	-	-	-
Critical Hdwy Stg 2	6.54	5.54	-	6.54	5.54	-	-	-	-	-	-	-
Follow-up Hdwy	3.52	4.02	3.32	3.52	4.02	3.32	2.22	-	-	2.22	-	-
Pot Cap-1 Maneuver	~ 13	8	333	~ 13	7	345	395	-	-	421	-	-
Stage 1	85	133	-	117	171	-	-	-	-	-	-	-
Stage 2	345	166	-	262	125	-	-	-	-	-	-	-
Platoon blocked, %								-	-	-	-	-
Mov Cap-1 Maneuver	-	~ 6	333	-	~ 5	345	395	-	-	421	-	-
Mov Cap-2 Maneuver	-	~ 6	-	-	~ 5	-	-	-	-	-	-	-
Stage 1	82	101	-	113	165	-	-	-	-	-	-	-
Stage 2	259	160	-	180	95	-	-	-	-	-	-	-

Approach	EB		WB		NB		SB	
HCM Control Delay, s					0.1		1	
HCM LOS	-		-					

Minor Lane/Major Mvmt	NBL	NBT	NBR	EBLn1	EBLn2	WBLn1	WBLn2	WBLn3	SBL	SBT	SBR
Capacity (veh/h)	395	-	-	-	16	-	5	345	421	-	-
HCM Lane V/C Ratio	0.037	-	-	-	1.053	-	1.263	0.189	0.243	-	-
HCM Control Delay (s)	14.5	-	-	-	\$ 568.5	-	\$ 1426.7	17.9	16.3	-	-
HCM Lane LOS	B	-	-	-	F	-	F	C	C	-	-
HCM 95th %tile Q(veh)	0.1	-	-	-	2.6	-	1.6	0.7	0.9	-	-

Notes
 -: Volume exceeds capacity \$: Delay exceeds 300s +: Computation Not Defined *: All major volume in platoon