

**FINAL DRAINAGE REPORT  
FOR  
CHAMBERS AND HESS FILING NO. 1**

**Job Number: D-1173**

January 25, 2021

RICK ENGINEERING COMPANY

ENGINEERING COMPANY

RICK ENGINEERING CO

**FINAL DRAINAGE REPORT**  
**FOR**  
**CHAMBERS AND HESS FILING NO. 1**  
**PARKER, COLORADO**

**Job Number: D-1173**

*Owner:*

**FIRST GUARDIAN GROUP, INC.**  
2025 Gateway Place, Suite 485  
San Jose, CA 95110

*Applicant/Developer:*

**REPUBLIC INVESTMENT GROUP**  
5750 DTC Parkway, Suite 160  
Greenwood Village, CO 80111

*Engineer:*

**RICK ENGINEERING COMPANY**  
9801 East Easter Avenue  
Centennial, CO 80112  
(303) 537-8020

January 25, 2021

## Certification

### Professional Engineer:

This report for the final design of Chambers and Hess Filing No. 1 was prepared by me or under my direct supervision in accordance with the provisions of the Town of Parker Storm Drainage and Environmental Criteria Manual. I understand that the Town of Parker and its designated town authority do not and will not assume liability for the drainage facilities designed by others.

---

Troy Bales  
Registered Professional Engineer  
State of Colorado No. 50961



## TABLE OF CONTENTS

A.	Hydrologic Computations .....	2
B.	Hydraulic Computations .....	2
C.	Drainage Plan .....	2
I.	GENERAL LOCATION AND DESCRIPTION .....	0
A.	Location.....	0
II.	DRAINAGE BASINS AND SUB-BASINS .....	0
A.	Major Basin Description .....	0
B.	Site Sub-Basin Description .....	1
III.	DRAINAGE DESIGN CRITERIA .....	1
A.	Regulations.....	1
B.	Discussion of compliance with the Town’s Stream Preservation Standards .....	1
C.	Development Criteria and Constraints .....	2
D.	Hydrology Criteria .....	2
E.	Hydraulic Criteria .....	2
F.	Variance from Criteria .....	2
IV.	DRAINAGE FACILITY DESIGN .....	3
A.	General Concept.....	3
B.	Specific Details .....	3
C.	Discussion of Detention Storage Required for Full-Spectrum Detention.....	3
D.	Discussion of Outlet Requirements.....	4
E.	Discussion of Storm Sewer Configuration .....	4
F.	Discussion on Channel Design and Soil Erodibility Within Channel .....	4
G.	Stormwater Utility Eligible Facilities .....	4
V.	ENVIRONMENTAL PROTECTION CRITERIA .....	4
A.	General .....	4
B.	Construction BMP Plan.....	4
C.	Permanent BMP Plan .....	5
VI.	CONCLUSIONS .....	5
A.	Compliance with Standards.....	5

B. Drainage Concept..... 5  
VII. REFERENCES ..... 5

**APPENDICES**

- A. Hydrologic Computations
- B. Hydraulic Computations
- C. Excerpts from Final Drainage Report for the Parker 234 Subdivision
- D. Drainage Plan

## **I. GENERAL LOCATION AND DESCRIPTION**

### **A. Location**

The Chambers and Hess Filing No. 1 development is in the Town of Parker, Douglas County, Colorado. More specifically, the development is located in the southeast one-quarter of Section 29, Township 6 South, Range 66 West of the Sixth Principal Meridian.

The subject site is also known as Block 10, Lot 1 of Douglas 234 Filing No. 1. The site is 13.803 acres in area. Chambers and Hess Filing No. 1 is located entirely within the Douglas 234 Filing No. 1 subdivision.

Bordering the Chambers and Hess Filing No. 1 development to the north is South Red Sky Drive, a residential collector street that transitions to a residential local street east of the existing traffic roundabout. To the south, Chambers and Hess Filing No. 1 development is bordered by existing Hess Road, an arterial roadway. South of Hess Road is the Stroh Ranch Development. West of Chambers and Hess Filing No. 1 development is existing Chambers Road, arterial roadway. East of Chambers and Hess Filing No. 1 development is Block 12, Lots 7-23, of Douglas 234 Filing No. 1, 1<sup>st</sup> Amendment.

Chambers and Hess Filing No. 1 is within the Cherry Creek watershed. Cherry Creek is located about 1.75 miles east of Chambers and Hess Filing No. 1.

A National Resources Conservation Service (NRCS) soils map is in the Appendix. Four distinct soil types are encountered within Chamber and Hess Filing No. 1. Newlin-Satanta (NsE) complex, Hydrologic Soil Group B, described as gravelly sandy clay loam. Kutch clay loam (KuE), Hydrologic Soil Group D, described as clay loam. Manzanola clay loam (Ma), Hydrologic Soil Group C, described as clay loam. Renohill-Buick (RmE) complex, Hydrologic Soil Group D, described as clay loam.

In the existing condition, Chambers and Hess Filing No. 1 is vacant ground composed of native grasses and only a few trees. The site generally slopes from west to east with grades varying between 1% and 28%. Along the western boundary, the land slopes to the west to Chambers Road. Along the southern boundary, land slopes to the south to Hess Road.

Chambers and Hess Filing No. 1 is proposed to be developed for commercial/retail development.

## **II. DRAINAGE BASINS AND SUB-BASINS**

### **A. Major Basin Description**

Chambers and Hess Filing No. 1 is located within two major drainage basins, Cherry Creek and Oak Gulch. Oak Gulch is tributary to Cherry Creek.

Chambers and Hess Filing No. 1 is approximately 2 miles upstream of Cherry Creek. The most recent Flood Hazard Area Delineation for Cherry Creek in 2003 by URS did not include Chambers and Hess Filing No. 1 in the report.

Oak Gulch was studied as part of the “Oak Gulch and Lemon Gulch Flood Hazard Area Delineation” (Reference 4). Chambers and Hess Filing No. 1 is part of sub-basin 109.

Chambers and Hess Filing No.1 is in FEMA Zone X, an area of minimal flood hazard. A FEMA LOMR will not be required.

The Chambers and Hess Filing No. 1 site was originally studied as part of the Parker 234 Subdivision Final Drainage Report (Reference 3). The report identified that the site is part of the Cherry Creek watershed and Oak Gulch watershed. The report assigned historic drainage basin C-3 (area tributary to Cherry Creek) and historic drainage basin D-3 (area tributary to Oak Gulch).

### **B. Site Sub-Basin Description**

Referring to the Historic Drainage Map in Appendix C, the basin designations were adopted from the Parker 234 Final Drainage Report to maintain clarity and continuity.

Historic Basins C1, C2, C3 and C4, tributary to Cherry Creek, drain from west to east. Basin C1 drains to an existing area inlet that was constructed as part of the Parker 234 subdivision improvements. The runoff then travels north and east via storm sewer to existing detention Pond “A”. Basin C2 drains from west to east, ultimately through the residential lots on Block 2 of Douglas 234 Filing No. 1, eventually to the existing Red Sky Drive, then to existing pond “A”. Basin C3 drains from west to east through the residential lots on Block 2 of Douglas 234 Filing No. 1, eventually to existing Detention Pond “A”. Detained runoff from Pond “A” is conveyed under Jordan Road to the east, to an unnamed drainage way that ultimately connects to Cherry Creek. Basin C4 drains to the north to Red Sky Drive, then to the east and ultimately captured by existing storm sewer and routed to Pond “A”.

Historic Basins D1 and D2, tributary to Oak Gulch, drain to the west and south to existing South Chambers Road and Hess Road. Runoff from Historic Basins D1 and D2 travels south on Chambers Road, then east on Hess Road, to Pond F (Reference 5). Runoff from Pond F is conveyed south, under Hess Road to Oak Gulch.

There is no offsite runoff that flows onto Chambers and Hess Filing No. 1.

## **III. DRAINAGE DESIGN CRITERIA**

### **A. Regulations**

Chambers and Hess Filing No. 1 is not located within a regulated flood plain, therefore, Chambers and Hess Filing No. 1 is in compliance with the Town of Parker’s floodplain ordinance.

### **B. Discussion of compliance with the Town’s Stream Preservation Standards**

Chambers and Hess Filing No. 1 is not located within the Town of Parker Stream Preservation Area. Nonetheless, Chambers and Filing No. 1 will implement BMP measures to ensure that no adverse impact to water quality due to land disturbances. There are no Minor or Major Modifications requested. There are no planned improvements that would be eligible for Mile High Flood District’s maintenance eligibility.

### **C. Development Criteria and Constraints**

Chambers and Hess Filing No. 1 will comply with the drainage improvements outlined in the Final Drainage Report for the Parker 234 Subdivision. The report assigned the area of Chambers and Hess Filing No. 1 as future commercial development, 95% impervious. Chambers and Hess Filing No. 1 is using 75% impervious for the commercial lots, according to Mile High Flood District Table 6-3 (see Appendix) Business: Suburban Area. The proposed impervious is 73%. By reducing the impervious area, there will be no adverse impact to the downstream drainage conveyance elements, including the existing storm sewer and existing detention Pond "A".

### **D. Hydrology Criteria**

The minor storm is the 5 year recurrence interval. The major storm is the 100 year recurrence interval.

The site is 13.80 acres. The Rational Method is the method used to determine runoff rates for the minor and major storm. Rational Method runoff coefficients are based on the NRCS Hydrologic Soil Ratings. The predominant soil type (10 acres), Newlin-Satanta, has Hydrologic Soil Group Rating as Type "B". There are also 5 acres of Type "C/D" rated soils. After consulting the Mile High Flood District about how to calculate Rational Method Runoff Coefficients when there are differing types of soils from a Hydrologic Soil Group Rating standpoint, they recommended to evaluate each basin based on where the basin is located with respect to the Hydrologic Soil Group Rating. The Rational Method Runoff Coefficients were calculated assuming the entire site is Type "C/D" soils for simplicity, yielding a more conservative estimate of developed runoff.

There are no detention facilities proposed for Chambers and Hess Filing No. 1. Existing detention pond "A" will receive developed runoff from Chambers and Hess Filing No. 1, as designated in the Final Drainage Report for the Parker 234 Subdivision.

### **E. Hydraulic Criteria**

Sliceroo Drive is a normal crowned roadway, 26' flowline to flowline. Street capacities for Sliceroo Drive are calculated using UD-Inlet Version 4.05. The minor storm flow depth is limited to no curb overtopping. Minor storm runoff can spread to the crown of the street. The major storm flow depth cannot exceed 12 inches. Appendix B contains street capacity calculations. UD-Inlet was also utilized to calculate proposed storm sewer inlet capture rates.

Hydraulic grade lines are calculated using Mile High Flood District's UD Sewer software. The hydraulic grade line for the minor storm must be located below the crown of the pipe. The hydraulic grade line for the major storm must be located at least 12" below finished grade as a maximum condition.

### **F. Variance from Criteria**

There are no variances from criteria being sought.

## **IV. DRAINAGE FACILITY DESIGN**

### **A. General Concept**

Chambers and Hess Filing No. 1 eleven proposed commercial lots. The specific developments within the commercial lots are unknown currently. This report will quantify the runoff tributary from each commercial lot in sizing the storm drainage infrastructure. The proposed storm sewer system will provide a stub to each lot so that when the lot is developed, they can utilize the connection to the storm sewer system to convey runoff from each commercial lot. The commercial lots are designated to be a maximum of 75% impervious.

The drive and commercial lots will convey runoff to proposed storm inlets and ultimately to the existing storm sewer stub constructed in Tract B of Parker 234 subdivision. There is no offsite runoff draining on the Chambers and Hess Filing No. 1. Runoff from Chambers and Hess Filing No. 1 is designated to be collected and conveyed by the proposed storm sewer system. Existing Pond "A" will ultimately receive the developed runoff from Chambers and Hess Filing No. 1.

The appendix contains design charts utilized to quantify developed runoff.

### **B. Specific Details**

The site is 13.80 acres and subdivided into 15 sub-basins to quantify developed storm runoff at various design points. Each sub-basin is evaluated for the proposed impervious improvements. Areas within the sub-basins are assigned land uses, Concrete or Asphalt Pavement, Drives and Walks, Landscape or lawns and Commercial areas. The Proposed Impervious calculation in the Appendix summarizes the percent impervious of each sub basin. Times of Concentrations are either calculated or assumed to be the minimum of 5 minutes. Design points are located to calculate runoff to determine if the drive has the capacity to convey runoff. Design points are also located at proposed inlets and manholes to calculate the cumulative effect of runoff as the runoff conveys downstream.

As previously discussed, each commercial lot will capture developed runoff that is conveyed to the storm sewer system constructed by this proposal. The proposed storm system will convey the major storm from each commercial lot to the existing storm sewer connection.

Referring to the proposed drainage map, sump inlets are located in Sliceroo Drive, near Hess Road at Design Points 9 and 10. The sump inlets are designed to provide 100% capture of the major storm. At no point does runoff ever exceed available street capacities for the minor or major storm.

### **C. Discussion of Detention Storage Required for Full-Spectrum Detention**

As previously discussed, Chambers and Hess Filing No. 1 is not required to have on site detention because the property was included in the tributary area to the existing detention Pond "A", about 1200 feet east of Chambers and Hess Filing No. 1. The appendices contain original design calculations for Pond "A". When Pond "A" was designed, the Chambers and Hess Filing No. 1 property was assigned a percent impervious of 95%. The proposed site impervious for Chambers and Hess Filing No. 1 is 68%. There is no additional drainage area tributary to Pond "A". Therefore, the detention volume requirements for Pond "A" are not adversely impacted by a

developed Chambers and Hess Filing No. 1 property because the pond will receive more pervious drainage area than originally designed.

#### **D. Discussion of Outlet Requirements**

The outlet structure for existing Pond “A” will require no further improvements due to the construction of Chambers and Hess Filing No. 1 as discussed in the previous section.

#### **E. Discussion of Storm Sewer Configuration**

The proposed storm sewer main is located within the commercial lots and Sliceroo Drive. The storm sewer main will have storm sewer inlets in the commercial lots to convey major storm runoff to the existing storm sewer stub in Tract B of Parker 234 Subdivision. The storm sewer main is routed through the site to convey developed runoff to the existing stub. The Final Drainage Report for Parker 234 Subdivision calculated the total developed storm runoff from the Chambers and Hess Filing No. 1 property to be in the minor storm, 34.7 cfs and 88.6 cfs in the major storm. By reducing the amount of impervious area, the total developed storm runoff from Chambers and Hess Filing No. 1 property in the minor and major storm respectively is: 28.7 cfs and 70.8 cfs.

UDSewer was utilized to calculate the Hydraulic Grade Line for the major and minor storm sewer. The major storm model used a tailwater elevation that corresponds to the tailwater elevation of existing manhole SDMH-2 in the Final Drainage Report for Parker 234 Subdivision. The minor storm tailwater elevation was calculated as normal depth pipe flow at Parker 234 SDMH-2. The Hydraulic Grade Line calculations are located in Appendix B.

#### **F. Discussion on Channel Design and Soil Erodibility Within Channel**

There are only minor drainage grass lined swales proposed for Chambers and Hess Filing No. 1. The calculations for these minor drainage grass lined swales are in the appendix. The relatively low developed runoff conveyed by these swales yield velocities less than 5 feet per second, resulting in stable grass swales that do not require grade drops or armoring.

#### **G. Stormwater Utility Eligible Facilities**

### **V. ENVIRONMENTAL PROTECTION CRITERIA**

#### **A. General**

There are no wetlands located in Chambers and Hess Filing No. 1. There are no “Waters of the U.S.” located in Chambers and Hess Filing No. 1.

#### **B. Construction BMP Plan**

Construction BMP’s will be implemented in a three phase schedule, initial, interim and final stabilization.

The initial phase will install construction fencing, perimeter construction BMP’s like Silt Fencing and Sediment Control Logs. Vehicle tracking control to reduce the tracking of soils into the surrounding public streets and subdivision. At existing storm drain inlets on Hess Road and

Red Sky Drive will have Inlet Protections installed to prevent sediments from entering existing storm drain systems.

The interim phase will have the erosion and sediment controls associated with ongoing construction and grading operations. As grading operations bring the ground to finished grade elevations, trenching for proposed utilities, and rough street cuts prior to paving, BMP's like Check Dams, Diversion Ditches are installed to reduce stormwater runoff to non erosive velocities.

The final phase is where the site is to be stabilized by revegetating disturbed areas, installing erosion control blankets or similar on steeper grades.

### **C. Permanent BMP Plan**

Chambers and Hess Filing No. 1 will utilize a regional Permanent BMP by discharging developed runoff to existing Pond "A". Pond "A" acts as the Water Quality Enhancement BMP for Chambers and Hess Filing No. 1.

## **VI. CONCLUSIONS**

### **A. Compliance with Standards**

The drainage plan for Chambers and Hess Filing No. 1 is compliant with Town of Parker's stormwater ordinances. Chambers and Hess Filing No. 1 is compliant with the Town of Parker's Storm Drainage and Environmental Criteria Manual by utilizing the design methods and requirements outlined in the SDECM.

### **B. Drainage Concept**

The drainage design for Chambers and Hess Filing No. 1 effectively controls developed runoff by constructing storm sewer and storm drain inlets that convey developed runoff to the existing storm sewer stub constructed in anticipation of commercial development. By reducing the impervious area from the original drainage concept ensures that there are no adverse downstream impacts to the existing storm drainage infrastructure within the Parker 234 subdivision.

## **VII. REFERENCES**

1. "Urban Storm Drainage Criteria Manual Volumes 1, 2 and 3". Urban Drainage and Flood Control District, 2016.
2. "Storm Drainage and Environmental Criteria Manual". Town of Parker, Colorado. February 2014.
3. "Final Drainage Report for the Parker 234 Subdivision Parker Colorado". CVL Consultants of Colorado, Inc. 2003.
4. "Oak Gulch and Lemon Gulch Flood Hazard Area Delineation". CH2M Hill. 2000.
5. "Addendum #2 to the Final Drainage Report for Douglas 234 Parker Colorado". CVL Consultants of Colorado, Inc. 2004.

## **Appendix A**

### **Hydrologic Computations**

## **Appendix A**

### **Hydrologic Computations**

# National Flood Hazard Layer FIRMette



39°29'52.64"N



## Legend

SEE FIS REPORT FOR DETAILED LEGEND AND INDEX MAP FOR FIRM PANEL LAYOUT

- |                                    |  |   |
|------------------------------------|--|---|
| <b>SPECIAL FLOOD HAZARD AREAS</b>  |  | Without Base Flood Elevation (BFE)<br>Zone A, V, A99  |
|                                    |  | With BFE or Depth Zone AE, AO, AH, VE, AR   |
|                                    |  | Regulatory Floodway   |
| <b>OTHER AREAS OF FLOOD HAZARD</b> |  | 0.2% Annual Chance Flood Hazard, Areas of 1% annual chance flood with average depth less than one foot or with drainage areas of less than one square mile Zone X |
|                                    |  | Future Conditions 1% Annual Chance Flood Hazard Zone X  |
|                                    |  | Area with Reduced Flood Risk due to Levee. See Notes. Zone X  |
|                                    |  | Area with Flood Risk due to Levee Zone D  |
| <b>OTHER AREAS</b>                 |  | NO SCREEN Area of Minimal Flood Hazard Zone X   |
|                                    |  | Effective LOMRs   |
| <b>GENERAL STRUCTURES</b>          |  | Area of Undetermined Flood Hazard Zone D  |
|                                    |  | Channel, Culvert, or Storm Sewer  |
|                                    |  | Levee, Dike, or Floodwall   |
| <b>OTHER FEATURES</b>              |  | 20.2 Cross Sections with 1% Annual Chance Water Surface Elevation   |
|                                    |  | 17.5 Cross Sections with 1% Annual Chance Water Surface Elevation   |
|                                    |  | Coastal Transect  |
|                                    |  | Base Flood Elevation Line (BFE)   |
|                                    |  | Limit of Study  |
| <b>MAP PANELS</b>                  |  | Jurisdiction Boundary   |
|                                    |  | Coastal Transect Baseline   |
|                                    |  | Profile Baseline  |
|                                    |  | Hydrographic Feature  |
|                                    |  | Digital Data Available  |
|                                    |  | No Digital Data Available   |
|                                    |  | Unmapped  |

The pin displayed on the map is an approximate point selected by the user and does not represent an authoritative property location.

This map complies with FEMA's standards for the use of digital flood maps if it is not void as described below. The basemap shown complies with FEMA's basemap accuracy standards

The flood hazard information is derived directly from the authoritative NFHL web services provided by FEMA. This map was exported on **11/25/2019 at 3:59:17 PM** and does not reflect changes or amendments subsequent to this date and time. The NFHL and effective information may change or become superseded by new data over time.

This map image is void if the one or more of the following map elements do not appear: basemap imagery, flood zone labels, legend, scale bar, map creation date, community identifiers, FIRM panel number, and FIRM effective date. Map images for unmapped and unmodernized areas cannot be used for regulatory purposes.

Hydrologic Soil Group—Castle Rock Area, Colorado



Soil Map may not be valid at this scale.

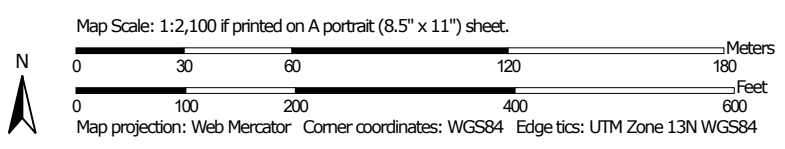

## MAP LEGEND

### Area of Interest (AOI)









 Area of Interest (AOI)

### Soils

#### Soil Rating Polygons





 A  
 A/D  
 B  
 B/D  
 C  
 C/D  
 D  
 Not rated or not available

#### Soil Rating Lines

 A  
 A/D  
 B  
 B/D  
 C  
 C/D  
 D  
 Not rated or not available

#### Soil Rating Points





 A  
 A/D  
 B  
 B/D

 C  
 C/D  
 D  
 Not rated or not available

### Water Features

 Streams and Canals

### Transportation

 Rails  
 Interstate Highways  
 US Routes  
 Major Roads  
 Local Roads

### Background

 Aerial Photography

## MAP INFORMATION

The soil surveys that comprise your AOI were mapped at 1:20,000.

**Warning:** Soil Map may not be valid at this scale.

Enlargement of maps beyond the scale of mapping can cause misunderstanding of the detail of mapping and accuracy of soil line placement. The maps do not show the small areas of contrasting soils that could have been shown at a more detailed scale.

Please rely on the bar scale on each map sheet for map measurements.

Source of Map: Natural Resources Conservation Service  
 Web Soil Survey URL:  
 Coordinate System: Web Mercator (EPSG:3857)

Maps from the Web Soil Survey are based on the Web Mercator projection, which preserves direction and shape but distorts distance and area. A projection that preserves area, such as the Albers equal-area conic projection, should be used if more accurate calculations of distance or area are required.

This product is generated from the USDA-NRCS certified data as of the version date(s) listed below.

Soil Survey Area: Castle Rock Area, Colorado  
 Survey Area Data: Version 12, Sep 13, 2019

Soil map units are labeled (as space allows) for map scales 1:50,000 or larger.

Date(s) aerial images were photographed: Jun 10, 2014—Aug 21, 2014

The orthophoto or other base map on which the soil lines were compiled and digitized probably differs from the background imagery displayed on these maps. As a result, some minor shifting of map unit boundaries may be evident.

## Hydrologic Soil Group

Map unit symbol	Map unit name	Rating	Acres in AOI	Percent of AOI
KuE	Kutch clay loam, 8 to 20 percent slopes	D	0.6	3.8%
Ma	Manzanola clay loam	C	3.5	23.1%
NsE	Newlin-Satanta complex, 5 to 20 percent slopes	B	9.9	64.6%
RmE	Renohill-Buick complex, 5 to 25 percent slopes	D	1.3	8.5%
<b>Totals for Area of Interest</b>			<b>15.3</b>	<b>100.0%</b>

### Description

Hydrologic soil groups are based on estimates of runoff potential. Soils are assigned to one of four groups according to the rate of water infiltration when the soils are not protected by vegetation, are thoroughly wet, and receive precipitation from long-duration storms.

The soils in the United States are assigned to four groups (A, B, C, and D) and three dual classes (A/D, B/D, and C/D). The groups are defined as follows:

Group A. Soils having a high infiltration rate (low runoff potential) when thoroughly wet. These consist mainly of deep, well drained to excessively drained sands or gravelly sands. These soils have a high rate of water transmission.

Group B. Soils having a moderate infiltration rate when thoroughly wet. These consist chiefly of moderately deep or deep, moderately well drained or well drained soils that have moderately fine texture to moderately coarse texture. These soils have a moderate rate of water transmission.

Group C. Soils having a slow infiltration rate when thoroughly wet. These consist chiefly of soils having a layer that impedes the downward movement of water or soils of moderately fine texture or fine texture. These soils have a slow rate of water transmission.

Group D. Soils having a very slow infiltration rate (high runoff potential) when thoroughly wet. These consist chiefly of clays that have a high shrink-swell potential, soils that have a high water table, soils that have a claypan or clay layer at or near the surface, and soils that are shallow over nearly impervious material. These soils have a very slow rate of water transmission.

If a soil is assigned to a dual hydrologic group (A/D, B/D, or C/D), the first letter is for drained areas and the second is for undrained areas. Only the soils that in their natural condition are in group D are assigned to dual classes.

## Rating Options

*Aggregation Method:* Dominant Condition

*Component Percent Cutoff:* None Specified

*Tie-break Rule:* Higher

**Table 6-4. Runoff coefficient equations based on NRCS soil group and storm return period**

NRCS Soil Group	Storm Return Period						
	2-Year	5-Year	10-Year	25-Year	50-Year	100-Year	500-Year
A	$C_A = 0.84i^{1.302}$	$C_A = 0.86i^{1.276}$	$C_A = 0.87i^{1.232}$	$C_A = 0.84i^{1.124}$	$C_A = 0.85i+0.025$	$C_A = 0.78i+0.110$	$C_A = 0.65i+0.254$
B	$C_B = 0.84i^{1.169}$	$C_B = 0.86i^{1.088}$	$C_B = 0.81i+0.057$	$C_B = 0.63i+0.249$	$C_B = 0.56i+0.328$	$C_B = 0.47i+0.426$	$C_B = 0.37i+0.536$
C/D	$C_{C/D} = 0.83i^{1.122}$	$C_{C/D} = 0.82i+0.035$	$C_{C/D} = 0.74i+0.132$	$C_{C/D} = 0.56i+0.319$	$C_{C/D} = 0.49i+0.393$	$C_{C/D} = 0.41i+0.484$	$C_{C/D} = 0.32i+0.588$

Where:

$i$  = % imperviousness (expressed as a decimal)

$C_A$  = Runoff coefficient for Natural Resources Conservation Service (NRCS) HSG A soils

$C_B$  = Runoff coefficient for NRCS HSG B soils

$C_{C/D}$  = Runoff coefficient for NRCS HSG C and D soils.

The values for various catchment imperviousness and storm return periods are presented graphically in Figures 6-1 through 6-3, and are tabulated in Table 6-5. These coefficients were developed for the Denver region to work in conjunction with the time of concentration recommendations in Section 2.4. Use of these coefficients and this procedure outside of the semi-arid climate found in the Denver region may not be valid. The UD-Rational Excel workbook performs all the needed calculations to find the runoff coefficient given the soil type and imperviousness and the reader may want to take advantage of this macro-enabled Excel workbook that is available for download from the UDFCD’s website [www.udfcd.org](http://www.udfcd.org).

See Examples 7.1 and 7.2 that illustrate the Rational Method.

**Table 6-3. Recommended percentage imperviousness values**

Land Use or Surface Characteristics	Percentage Imperviousness (%)
<b>Business:</b>	
Downtown Areas	95
Suburban Areas	75
<b>Residential lots (lot area only):</b>	
Single-family	
2.5 acres or larger	12
0.75 – 2.5 acres	20
0.25 – 0.75 acres	30
0.25 acres or less	45
Apartments	75
<b>Industrial:</b>	
Light areas	80
Heavy areas	90
<b>Parks, cemeteries</b>	10
<b>Playgrounds</b>	25
<b>Schools</b>	55
<b>Railroad yard areas</b>	50
<b>Undeveloped Areas:</b>	
Historic flow analysis	2
Greenbelts, agricultural	2
Off-site flow analysis (when land use not defined)	45
<b>Streets:</b>	
Paved	100
Gravel (packed)	40
Drive and walks	90
Roofs	90
Lawns, sandy soil	2
Lawns, clayey soil	2

PROJECT: CHAMBERS AND HESS FILING NO. 1  
 SUBJECT: HISTORIC IMPERVIOUSNESS

JOB #: D01173  
 DATE: 1/25/2021  
 BY: BHE

Basin Name	Square Footage	Acres	Native Ground (sf)	Native Ground (Acres)	Gravel (sf)	Gravel (Acres)	Roofs (sf)	Roofs (Acres)	Soil Type "C/D" Composite Runoff Factors			
									C <sub>2</sub>	C <sub>5</sub>	C <sub>100</sub>	I %
C1	417,552	9.59	417,552	9.59	0	0.00	0	0.00	0.01	0.05	0.49	2.0
C2	28,133	0.65	28,133	0.65	0	0.00	0	0.00	0.01	0.05	0.49	2.0
C3	8,776	0.20	8,776	0.20	0	0.00	0	0.00	0.01	0.05	0.49	2.0
C4	2,644	0.06	2,644	0.06	0	0.00	0	0.00	0.01	0.05	0.49	2.0
D1	75,297	1.73	75,297	1.73	0	0.00	0	0.00	0.01	0.05	0.49	2.0
D2	68,188	1.57	68,188	1.57	0	0.00	0	0.00	0.01	0.05	0.49	2.0

Land Use	Imp., I %
Native Ground	2%
Gravel	40%
Roofs	90%

PROJECT: CHAMBERS AND HESS FILING NO. 1  
 SUBJECT: TIME OF CONCENTRATION

JOB #: D01173  
 DATE: 1/25/2021  
 BY: BHE

### TIME OF CONCENTRATION

			TIME (Ti) [Max. 300']					TRAVEL TIME (Tt)							Tc CHECK		FINAL	Time to	Remarks
Basin No.	Area (acres)	5Yr. co-eff.	Elevations		Dist. (ft)	Slope (%)	Ti (min)	Elevations		Dist. (ft)	Slope (%)	*	Vel. (fps)	Tt (min)	Tc		Tc (min)	Peak** Flow	
			Upstream	Downstream				Upstream	Downstream						Tc	(min)			
C1	9.59	0.05	6085.1	6074.0	196	5.7	14.9	6074.0	6054.0	408	4.9	3	1.8	3.7	18.6	29.0	18.6	29.0	NON URBANIZED
C2	0.65	0.05																5.0	ASSUME MIN TC
C3	0.20	0.05	6070.0	6064.0	143	4.2	14.1	6064.0	6059.0	172	2.9	3	1.2	2.3	16.4	27.5	16.4	27.5	NON URBANIZED
C4	0.06	0.05																5.0	ASSUME MIN TC
D1	1.73	0.05	6085.4	6084.0	76	1.8	13.6	6084.0	6082.0	64	3.1	3	1.3	0.8	14.4	26.3	14.4	26.3	NON URBANIZED
D2	1.57	0.05	6086.0	6083.1	84	3.5	11.5	6083.1	6054.7	512	5.5	3	2.0	4.4	15.8	29.6	15.8	29.6	NON URBANIZED

\* Type of Land Surface for Overland Travel Time

VELOCITY COEFFICIENTS

- 1 = Heavy Meadow
- 2 = Tillage / Field
- 3 = Short pasture & lawns
- 4 = Nearly bare ground
- 5 = Grassed waterway
- 6 = Paved areas and shallow paved swales

- 1 2.5
- 2 5
- 3 7
- 4 10
- 5 15
- 6 20

**STANDARD FORM SF-3  
STORM DRAINAGE SYSTEM DESIGN  
(RATIONAL METHOD PROCEDURE)**

CALCULATED BY:  
DATE:  
CHECKED BY:

**BHE**  
**1/25/21**

**P1= 1.39**

**JOB NO: D01173**  
**PROJECT: CHAMBERS AND HESS FILING NO. 1**  
**DESIGN STORM: 5 Year**

BASIN	DESIGN POINT	DIRECT RUNOFF							TOTAL RUNOFF				STREET		PIPE			TRAVEL TIME			REMARKS
		AREA DESIG.	AREA (Acres)	RUNOFF COEFF	Tc (min)	C A (Acres)	I (in/hour)	Q (cfs)	Tc (min)	(CA) (Acres)	I (in/hour)	Q (cfs)	SLOPE (%)	STREET FLOW (cfs)	DESIGN FLOW (cfs)	SLOPE (%)	PIPE SIZE (in)	LENGTH (ft)	VELOCITY (fps)	Tt (min)	
C1	1	C1	9.59	0.05	29.0	0.49	2.23	1.1													
C2			0.65	0.05	5.0	0.03	4.71	0.2													
C3			0.20	0.05	27.5	0.01	2.30	0.0													
C4			0.06	0.05	5.0	0.00	4.71	0.0													
D1			1.73	0.05	26.3	0.09	2.35	0.2													
D2			1.57	0.05	29.6	0.08	2.20	0.2													

**STANDARD FORM SF-3  
STORM DRAINAGE SYSTEM DESIGN  
(RATIONAL METHOD PROCEDURE)**

CALCULATED BY:  
DATE:  
CHECKED BY:

**BHE**  
1/25/21

P1= 2.60

JOB NO: D01173  
PROJECT: CHAMBERS AND HESS FILING NO. 1  
DESIGN STORM: 100 YEAR

BASIN	DESIGN POINT	DIRECT RUNOFF							TOTAL RUNOFF				STREET		PIPE			TRAVEL TIME			REMARKS
		AREA DESIG.	AREA (Acres)	RUNOFF COEFF	Tc (min)	C A (Acres)	I (in/hour)	Q (cfs)	Tc (min)	(CA) (Acres)	I (in/hour)	Q (cfs)	SLOPE (%)	STREET FLOW (cfs)	DESIGN FLOW (cfs)	SLOPE (%)	PIPE SIZE (in)	LENGTH (ft)	VELOCITY (fps)	Tt (min)	
C1	1	C1	9.59	0.49	29.0	4.72	4.16	19.6													
C2			0.65	0.49	5.0	0.32	8.82	2.8													
C3			0.20	0.49	27.5	0.10	4.29	0.4													
C4			0.06	0.49	5.0	0.03	8.82	0.3													
D1			1.73	0.49	26.3	0.85	4.40	3.7													
D2			1.57	0.49	29.6	0.77	4.11	3.2													



PROJECT: CHAMBERS AND HESS FILING NO. 1  
 SUBJECT: TIME OF CONCENTRATION

JOB #: D01173  
 DATE: 1/25/2021  
 BY: BHE

### TIME OF CONCENTRATION

			TIME (Ti) [Max. 300']					TRAVEL TIME (Tt)						Tc CHECK		FINAL Tc	Time to Peak**	Remarks	
Basin No.	Area (acres)	5Yr. co-eff.	Elevations		Dist. (ft)	Slope (%)	Ti (min)	Elevations		Dist. (ft)	Slope (%)	*	Vel. (fps)	Tt (min)	Tc		Tc (min)		Peak** Flow
			Upstream	Downstream				Upstream	Downstream						Tc	Tc			
A1	0.91	0.65																5.0	Assume Min Tc
A2	0.65	0.65																5.0	Assume Min Tc
A3	1.18	0.65																5.0	Assume Min Tc
A4	0.88	0.65																5.0	Assume Min Tc
A5	0.81	0.65																5.0	Assume Min Tc
A6	1.72	0.65																5.0	Assume Min Tc
A7	0.79	0.65																5.0	Assume Min Tc
A8	0.61	0.65																5.0	Assume Min Tc
A9	0.96	0.46	6077.8	6076.9	25	3.7	3.8	6076.9	6053.9	1070	2.2	6	2.9	6.2	10.0	24.6	10.0	10.0	
A10	0.84	0.51	6077.4	6076.8	20	2.9	3.4	6076.8	6053.1	1101	2.2	6	2.9	6.4	9.8	23.5	9.8	9.8	
A11	0.72	0.65																5.0	Assume Min Tc
A12	1.38	0.65																5.0	Assume Min Tc
A13	1.59	0.65																5.0	Assume Min Tc
A14	0.41	0.05																5.0	Assume Min Tc
OS1	0.33	0.05																5.0	Assume Min Tc
RSD1	0.26	0.73	6086.2	6084.6	51	3.2	3.2	6084.6	6078.9	237	2.4	6	3.0	1.3	4.5	12.8	4.5	5.0	
HESS1	1.30	0.67	6074.1	6072.7	67	2.1	5.0	6072.7	6055.2	644	2.7	6	3.2	3.4	8.4	16.1	8.4	8.4	Assume Min Tc
HESS2	0.06	0.74																5.0	Assume Min Tc

\* Type of Land Surface for Overland Travel Time

VELOCITY COEFFICIENTS

- 1 = Heavy Meadow
- 2 = Tillage / Field
- 3 = Short pasture & lawns
- 4 = Nearly bare ground
- 5 = Grassed waterway
- 6 = Paved areas and shallow paved swales

1	2.5
2	5
3	7
4	10
5	15
6	20

**STANDARD FORM SF-3  
STORM DRAINAGE SYSTEM DESIGN  
(RATIONAL METHOD PROCEDURE)**

CALCULATED BY:  
DATE:  
CHECKED BY:

**BHE**  
**1/25/21**

**P1= 1.39**

**JOB NO: D01173**  
**PROJECT: CHAMBERS AND HESS FILING NO. 1**  
**DESIGN STORM: 5 Year**

BASIN	DESIGN POINT	DIRECT RUNOFF							TOTAL RUNOFF				STREET		PIPE			TRAVEL TIME			REMARKS
		AREA DESIG.	AREA (Acres)	RUNOFF COEFF	Tc (min)	C A (Acres)	I (in/hour)	Q (cfs)	Tc (min)	(C A) (Acres)	I (in/hour)	Q (cfs)	SLOPE (%)	STREET FLOW (cfs)	DESIGN FLOW (cfs)	SLOPE (%)	PIPE SIZE (in)	LENGTH (ft)	VELOCITY (fps)	Tt (min)	
A1	1	A1	0.91	0.65	5.0	0.59	4.71	<b>2.8</b>							2.8	1.7	18	102	6.1	0.3	INL-10 TO INL-09
A2	2	A2	0.65	0.65	5.0	0.42	4.71	<b>2.0</b>													
	2	A1+A2							5.3	1.02	4.65	<b>4.7</b>			4.7	1.4	18	178	6.5	0.5	INL-09 TO INL-08
A3	3	A3	1.18	0.65	5.0	0.77	4.71	<b>3.6</b>													
	3	A1-A3							5.7	1.78	4.54	<b>8.1</b>			8.1	2.8	24	125	9.5	0.2	INL-08 TO INL-07
A4	4	A4	0.88	0.65	5.0	0.57	4.71	<b>2.7</b>													
	4	A1-A4							6.0	2.36	4.49	<b>10.6</b>			10.6	1.8	24	228	8.7	0.4	INL-07 TO INL-05
A5			0.81	0.65	5.0	0.53	4.71	<b>2.5</b>													
	5	A1-A5							6.4	2.89	4.40	<b>12.7</b>			12.7	7.3	24	132	15.2	0.1	INL-05 TO SDMH-01
A6	6	A6	1.72	0.65	5.0	1.12	4.71	<b>5.3</b>							5.3	3.0	18	142	8.8	0.3	INL-14 TO INL-13
A7	7	A6-A7	0.79	0.65	5.0	0.51	4.71	<b>2.4</b>	5.3	1.63	4.65	<b>7.6</b>			7.6	6.3	24	111	12.3	0.2	INL-13 TO INL-12
A8	8	A6-A8	0.61	0.65	5.0	0.39	4.71	<b>1.9</b>	5.4	2.03	4.61	<b>9.4</b>			9.4	4.6	24	72	11.8	0.1	INL-12 TO INL-11
RSD1			0.26	0.73	5.0	0.19	4.71	<b>0.9</b>					2.3	0.9				1096	2.9	6.2	TO INL-11
HESS2	9		0.06	0.74	5.0	0.05	4.71	<b>0.2</b>													TO INL-11
A9	9	A9+HESS2+RSD1	0.96	0.46	10.0	0.44	3.76	<b>1.7</b>	11.2	0.68	3.59	<b>2.4</b>									INL-11 DESIGN Q
	9	A6-A9+HESS2+RSD1							11.2	2.70	3.59	<b>9.7</b>			9.7	0.5	24	6	5.3	0.0	DP9: RUNOFF LEAVING INL-11 TO SDMH-02
A10	10	A10	0.84	0.51	9.8	0.43	3.79	<b>1.6</b>							1.6	0.5	18	19	3.3	0.1	INL-16 TO SDMH-02
	11	A6-A10+HESS2+RSD1							11.2	3.13	3.59	<b>11.2</b>			11.2	0.5	30	290	5.5	0.9	SDMH-02 TO SDMH-01
	12	A1-A10+HESS2+RSD1							12.1	6.02	3.48	<b>20.9</b>			20.9	0.5	36	194	6.5	0.5	SDMH-01 TO INL-04
A11	13	A1-A11+HESS2+RSD1	0.72	0.65	5.0	0.47	4.71	<b>2.2</b>	12.6	6.49	3.41	<b>22.1</b>			22.1	2.7	36	83	12.1	0.1	INL-04 TO INL-02
A12	14	A12	1.38	0.65	5.0	0.90	4.71	<b>4.2</b>							4.2	8.8	18	174	11.9	0.2	INL-03 TO INL-02
A13	15	A13	1.59	0.65	5.0	1.03	4.71	<b>4.9</b>													
	15	A1-A13+HESS2+RSD1							12.7	8.42	3.40	<b>28.6</b>			28.6	4.3	36	33	15.2	0.0	INL-02 TO INL-01



**STANDARD FORM SF-3  
STORM DRAINAGE SYSTEM DESIGN  
(RATIONAL METHOD PROCEDURE)**

CALCULATED BY:  
DATE:  
CHECKED BY:

**BHE**  
**1/25/21**

**P1= 2.60**

**JOB NO: D01173**  
**PROJECT: CHAMBERS AND HESS FILING NO. 1**  
**DESIGN STORM: 100 YEAR**

BASIN	DESIGN POINT	DIRECT RUNOFF							TOTAL RUNOFF				STREET		PIPE			TRAVEL TIME			REMARKS
		AREA DESIG.	AREA (Acres)	RUNOFF COEFF	Tc (min)	C A (Acres)	I (in/hour)	Q (cfs)	Tc (min)	(C A) (Acres)	I (in/hour)	Q (cfs)	SLOPE (%)	STREET FLOW (cfs)	DESIGN FLOW (cfs)	SLOPE (%)	PIPE SIZE (in)	LENGTH (ft)	VELOCITY (fps)	Tt (min)	
A1	1	A1	0.91	0.79	5.0	0.72	8.82	<b>6.4</b>							6.4	1.7	18	102	7.6	0.2	INL-10 TO INL-09
A2	2		0.65	0.79	5.0	0.52	8.82	<b>4.6</b>													
	2	A1+A2							5.2	1.24	8.72	<b>10.8</b>			10.8	1.4	18	178	7.9	0.4	INL-09 TO INL-08
A3	3		1.18	0.79	5.0	0.93	8.82	<b>8.2</b>													
	3	A1-A3							5.6	2.17	8.55	<b>18.6</b>			18.6	2.8	24	125	11.9	0.2	INL-08 TO INL-07
A4	4		0.88	0.79	5.0	0.70	8.82	<b>6.2</b>													
	4	A1-A4							5.8	2.87	8.48	<b>24.3</b>			24.3	1.8	24	228	11.0	0.3	INL-07 TO INL-05
A5	5		0.81	0.79	5.0	0.64	8.82	<b>5.7</b>													
	5	A1-A5							6.1	3.51	8.33	<b>29.3</b>			29.3	7.3	24	132	19.0	0.1	INL-05 TO SDMH-01
A6	6	A6	1.72	0.79	5.0	1.36	8.82	<b>12.0</b>						12.0	3.0	18	142	11.0	0.2	INL-14 TO INL-13	
A7	7	A6-A7	0.79	0.79	5.0	0.62	8.82	<b>5.5</b>	5.2	1.99	8.72	<b>17.3</b>			17.3	6.3	24	111	15.8	0.1	INL-13 TO INL-12
A8	8	A6-A8	0.61	0.79	5.0	0.48	8.82	<b>4.2</b>	5.3	2.47	8.67	<b>21.4</b>			21.4	4.6	24	72	14.9	0.1	INL-12 TO INL-11
OS1			0.33	0.49	5.0	0.16	8.82	<b>1.4</b>													
HESS1	17	HESS1	1.30	0.80	8.4	1.04	7.52	<b>7.8</b>	8.4	1.21	7.52	<b>9.1</b>									
									8.4	0.92	7.52	<b>6.9</b>									CAPTURED BY INLET INL-15 BYPASSED INLET 16 TO INLET A11
RSD1			0.26	0.83	5.0	0.22	8.82	<b>1.9</b>	8.4	0.29	7.52	<b>2.2</b>	2.3	1.9				1096	2.9	6.2	TO INL-11
HESS2			0.06	0.83	5.0	0.05	8.82	<b>0.5</b>													TO INL-11
A9	9	A9+HESS1+HESS2+RSD1	0.96	0.70	10.0	0.67	7.04	<b>4.7</b>	11.2	1.22	6.72	<b>8.2</b>									INL-11 INLET DESIGN
		A6-A9+HESS1+HESS2+RSD1							11.2	3.69	6.72	<b>24.8</b>			24.8	0.5	24	6	7.9	0.0	DP9: RUNOFF LEAVING INL-11
A10	10	A10	0.84	0.72	9.8	0.61	7.09	<b>4.3</b>						4.3	0.5	18	19	4.4	0.1		INL-10 TO SDMH-02
	11	A6-A10+HESS1+HESS2+RSD1							11.2	4.30	6.71	<b>28.9</b>			28.9	0.5	24	290	9.0	0.5	SDMH-02 TO SDMH-01
	12	A1-A10+HESS1+HESS2+RSD1							11.8	7.81	6.58	<b>51.4</b>			51.4	0.5	36	194	8.3	0.4	SDMH-01 TO INL-04
A11	13	A1-A11+HESS1+HESS2+RSD1	0.72	0.79	5.0	0.57	8.82	<b>5.0</b>	12.2	8.38	6.49	<b>54.4</b>			54.4	2.7	36	83	15.3	0.1	INL-04 TO INL-02



## **Appendix B**

### **Hydraulic Computations**

**ALLOWABLE CAPACITY FOR ONE-HALF OF STREET (Minor & Major Storm)**

(Based on Regulated Criteria for Maximum Allowable Flow Depth and Spread)

Project: **CHAMBERS AND HESS**  
 Inlet ID: **DRIVE A STREET CAPACITY**

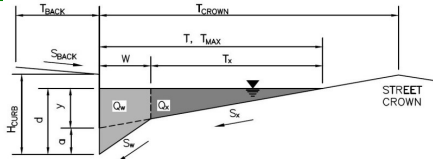

THE DRIVE A STREET CAPACITIES ARE SUMMARIZED IN A RATING CURVE AT VARIOUS STREET LONGITUDINAL SLOPES

<b>Gutter Geometry (Enter data in the blue cells)</b>					
Maximum Allowable Width for Spread Behind Curb	$T_{BACK} = 5.0$ ft				
Side Slope Behind Curb (leave blank for no conveyance credit behind curb)	$S_{BACK} = 0.020$ ft/ft				
Manning's Roughness Behind Curb (typically between 0.012 and 0.020)	$n_{BACK} = 0.020$				
Height of Curb at Gutter Flow Line	$H_{CURB} = 6.00$ inches				
Distance from Curb Face to Street Crown	$T_{CROWN} = 13.0$ ft				
Gutter Width	$W = 2.00$ ft				
Street Transverse Slope	$S_X = 0.020$ ft/ft				
Gutter Cross Slope (typically 2 inches over 24 inches or 0.083 ft/ft)	$S_W = 0.083$ ft/ft				
Street Longitudinal Slope - Enter 0 for sump condition	$S_0 = 0.005$ ft/ft				
Manning's Roughness for Street Section (typically between 0.012 and 0.020)	$n_{STREET} = 0.016$				
Max. Allowable Spread for Minor & Major Storm	<table border="1" style="display: inline-table; border-collapse: collapse;"> <tr> <th style="padding: 2px;">Minor Storm</th> <th style="padding: 2px;">Major Storm</th> </tr> <tr> <td style="text-align: center; padding: 2px;">13.0</td> <td style="text-align: center; padding: 2px;">13.0</td> </tr> </table> ft	Minor Storm	Major Storm	13.0	13.0
Minor Storm	Major Storm				
13.0	13.0				
Max. Allowable Depth at Gutter Flowline for Minor & Major Storm	<table border="1" style="display: inline-table; border-collapse: collapse;"> <tr> <th style="padding: 2px;">Minor Storm</th> <th style="padding: 2px;">Major Storm</th> </tr> <tr> <td style="text-align: center; padding: 2px;">6.0</td> <td style="text-align: center; padding: 2px;">12.0</td> </tr> </table> inches	Minor Storm	Major Storm	6.0	12.0
Minor Storm	Major Storm				
6.0	12.0				
Allow Flow Depth at Street Crown (leave blank for no)	<input type="checkbox"/> Minor Storm <input checked="" type="checkbox"/> Major Storm    check = yes				
<b>Maximum Capacity for 1/2 Street based On Allowable Spread</b>					
Water Depth without Gutter Depression (Eq. ST-2)	$y = 3.12$ inches				
Vertical Depth between Gutter Lip and Gutter Flowline (usually 2")	$d_c = 2.0$ inches				
Gutter Depression ( $d_c - (W * S_x * 12)$ )	$a = 1.51$ inches				
Water Depth at Gutter Flowline	$d = 4.63$ inches				
Allowable Spread for Discharge outside the Gutter Section W (T - W)	$T_X = 11.0$ ft				
Gutter Flow to Design Flow Ratio by FHWA HEC-22 method (Eq. ST-7)	$E_0 = 0.456$				
Discharge outside the Gutter Section W, carried in Section $T_X$	$Q_X = 2.2$ cfs				
Discharge within the Gutter Section W ( $Q_T - Q_X$ )	$Q_W = 1.8$ cfs				
Discharge Behind the Curb (e.g., sidewalk, driveways, & lawns)	$Q_{BACK} = 0.0$ cfs				
<b>Maximum Flow Based On Allowable Spread</b>	$Q_T = 4.0$ cfs				
Flow Velocity within the Gutter Section	$V = 3.0$ fps				
$V*d$ Product: Flow Velocity times Gutter Flowline Depth	$V*d = 1.2$				
<b>Maximum Capacity for 1/2 Street based on Allowable Depth</b>					
Theoretical Water Spread	$T_{TH} = 18.7$ ft				
Theoretical Spread for Discharge outside the Gutter Section W (T - W)	$T_{XTH} = 16.7$ ft				
Gutter Flow to Design Flow Ratio by FHWA HEC-22 method (Eq. ST-7)	$E_0 = 0.318$				
Theoretical Discharge outside the Gutter Section W, carried in Section $T_{XTH}$	$Q_{XTH} = 6.6$ cfs				
Actual Discharge outside the Gutter Section W, (limited by distance $T_{CROWN}$ )	$Q_X = 6.3$ cfs				
Discharge within the Gutter Section W ( $Q_d - Q_X$ )	$Q_W = 3.1$ cfs				
Discharge Behind the Curb (e.g., sidewalk, driveways, & lawns)	$Q_{BACK} = 0.0$ cfs				
Total Discharge for Major & Minor Storm (Pre-Safety Factor)	$Q = 9.4$ cfs				
Average Flow Velocity Within the Gutter Section	$V = 3.7$ fps				
$V*d$ Product: Flow Velocity Times Gutter Flowline Depth	$V*d = 1.9$				
Slope-Based Depth Safety Reduction Factor for Major & Minor ( $d \geq 6"$ ) Storm	$R = 1.00$				
<b>Max Flow Based on Allowable Depth (Safety Factor Applied)</b>	$Q_d = 9.4$ cfs				
Resultant Flow Depth at Gutter Flowline (Safety Factor Applied)	$d = 6.00$ inches				
Resultant Flow Depth at Street Crown (Safety Factor Applied)	$d_{CROWN} = 1.37$ inches				
<b>MINOR STORM Allowable Capacity is based on Spread Criterion</b>					
<b>MAJOR STORM Allowable Capacity is based on Depth Criterion</b>					
<b>Minor storm max. allowable capacity GOOD - greater than the design flow given on sheet 'Inlet Management'</b>					
<b>Major storm max. allowable capacity GOOD - greater than the design flow given on sheet 'Inlet Management'</b>					

**ALLOWABLE CAPACITY FOR ONE-HALF OF STREET (Minor & Major Storm)**

(Based on Regulated Criteria for Maximum Allowable Flow Depth and Spread)

Project: **CHAMBERS AND HESS**  
 Inlet ID: **DRIVE A STREET CAPACITY**

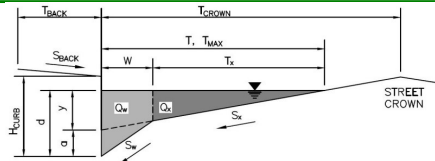

**Gutter Geometry (Enter data in the blue cells)**

Maximum Allowable Width for Spread Behind Curb  
 Side Slope Behind Curb (leave blank for no conveyance credit behind curb)  
 Manning's Roughness Behind Curb (typically between 0.012 and 0.020)

Height of Curb at Gutter Flow Line  
 Distance from Curb Face to Street Crown  
 Gutter Width  
 Street Transverse Slope  
 Gutter Cross Slope (typically 2 inches over 24 inches or 0.083 ft/ft)  
 Street Longitudinal Slope - Enter 0 for sump condition  
 Manning's Roughness for Street Section (typically between 0.012 and 0.020)

Max. Allowable Spread for Minor & Major Storm  
 Max. Allowable Depth at Gutter Flowline for Minor & Major Storm  
 Allow Flow Depth at Street Crown (leave blank for no)

$T_{BACK}$ =	5.0	ft
$S_{BACK}$ =	0.020	ft/ft
$n_{BACK}$ =	0.020	
$H_{CURB}$ =	6.00	inches
$T_{CROWN}$ =	13.0	ft
$W$ =	2.00	ft
$S_x$ =	0.020	ft/ft
$S_w$ =	0.083	ft/ft
$S_0$ =	0.010	ft/ft
$n_{STREET}$ =	0.016	

	Minor Storm	Major Storm	
$T_{MAX}$ =	13.0	13.0	ft
$d_{MAX}$ =	6.0	12.0	inches
	<input type="checkbox"/>	<input checked="" type="checkbox"/>	check = yes

**Maximum Capacity for 1/2 Street based On Allowable Spread**

Water Depth without Gutter Depression (Eq. ST-2)  
 Vertical Depth between Gutter Lip and Gutter Flowline (usually 2")  
 Gutter Depression ( $d_c - (W * S_x * 12)$ )  
 Water Depth at Gutter Flowline  
 Allowable Spread for Discharge outside the Gutter Section W (T - W)  
 Gutter Flow to Design Flow Ratio by FHWA HEC-22 method (Eq. ST-7)  
 Discharge outside the Gutter Section W, carried in Section  $T_x$   
 Discharge within the Gutter Section W ( $Q_T - Q_x$ )  
 Discharge Behind the Curb (e.g., sidewalk, driveways, & lawns)

**Maximum Flow Based On Allowable Spread**

Flow Velocity within the Gutter Section  
 $V*d$  Product: Flow Velocity times Gutter Flowline Depth

	Minor Storm	Major Storm	
$y$ =	3.12	3.12	inches
$d_c$ =	2.0	2.0	inches
$a$ =	1.51	1.51	inches
$d$ =	4.63	4.63	inches
$T_x$ =	11.0	11.0	ft
$E_0$ =	0.456	0.456	
$Q_x$ =	3.1	3.1	cfs
$Q_w$ =	2.6	2.6	cfs
$Q_{BACK}$ =	0.0	0.0	cfs
$Q_T$ =	5.7	5.7	cfs
$V$ =	4.3	4.3	fps
$V*d$ =	1.6	1.6	

**Maximum Capacity for 1/2 Street based on Allowable Depth**

Theoretical Water Spread  
 Theoretical Spread for Discharge outside the Gutter Section W (T - W)  
 Gutter Flow to Design Flow Ratio by FHWA HEC-22 method (Eq. ST-7)  
 Theoretical Discharge outside the Gutter Section W, carried in Section  $T_{XTH}$   
 Actual Discharge outside the Gutter Section W, (limited by distance  $T_{CROWN}$ )  
 Discharge within the Gutter Section W ( $Q_d - Q_x$ )  
 Discharge Behind the Curb (e.g., sidewalk, driveways, & lawns)  
 Total Discharge for Major & Minor Storm (Pre-Safety Factor)  
 Average Flow Velocity Within the Gutter Section  
 $V*d$  Product: Flow Velocity Times Gutter Flowline Depth  
 Slope-Based Depth Safety Reduction Factor for Major & Minor ( $d \geq 6"$ ) Storm

**Max Flow Based on Allowable Depth (Safety Factor Applied)**

Resultant Flow Depth at Gutter Flowline (Safety Factor Applied)  
 Resultant Flow Depth at Street Crown (Safety Factor Applied)

	Minor Storm	Major Storm	
$T_{TH}$ =	18.7	43.7	ft
$T_{XTH}$ =	16.7	41.7	ft
$E_0$ =	0.318	0.130	
$Q_{XTH}$ =	9.4	107.8	cfs
$Q_x$ =	8.9	60.2	cfs
$Q_w$ =	4.4	16.2	cfs
$Q_{BACK}$ =	0.0	9.9	cfs
$Q$ =	13.2	86.3	cfs
$V$ =	5.2	8.8	fps
$V*d$ =	2.6	8.8	
$R$ =	1.00	1.00	
$Q_d$ =	13.2	86.3	cfs
$d$ =	6.00	12.00	inches
$d_{CROWN}$ =	1.37	7.37	inches

**MINOR STORM Allowable Capacity is based on Spread Criterion**  
**MAJOR STORM Allowable Capacity is based on Depth Criterion**

	Minor Storm	Major Storm	
$Q_{allow}$ =	5.7	86.3	cfs

**Minor storm max. allowable capacity GOOD - greater than the design flow given on sheet 'Inlet Management'**  
**Major storm max. allowable capacity GOOD - greater than the design flow given on sheet 'Inlet Management'**

**ALLOWABLE CAPACITY FOR ONE-HALF OF STREET (Minor & Major Storm)**

(Based on Regulated Criteria for Maximum Allowable Flow Depth and Spread)

Project:  
Inlet ID:

**CHAMBERS AND HESS  
DRIVE A STREET CAPACITY**

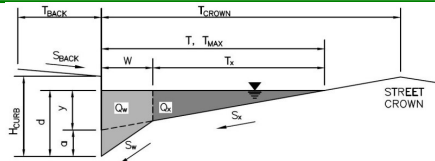

**Gutter Geometry (Enter data in the blue cells)**

Maximum Allowable Width for Spread Behind Curb  
Side Slope Behind Curb (leave blank for no conveyance credit behind curb)  
Manning's Roughness Behind Curb (typically between 0.012 and 0.020)

T <sub>BACK</sub> =	5.0	ft
S <sub>BACK</sub> =	0.020	ft/ft
n <sub>BACK</sub> =	0.020	

Height of Curb at Gutter Flow Line  
Distance from Curb Face to Street Crown  
Gutter Width  
Street Transverse Slope  
Gutter Cross Slope (typically 2 inches over 24 inches or 0.083 ft/ft)  
Street Longitudinal Slope - Enter 0 for sump condition  
Manning's Roughness for Street Section (typically between 0.012 and 0.020)

H <sub>CURB</sub> =	6.00	inches
T <sub>CROWN</sub> =	13.0	ft
W =	2.00	ft
S <sub>x</sub> =	0.020	ft/ft
S <sub>w</sub> =	0.083	ft/ft
S <sub>0</sub> =	0.020	ft/ft
n <sub>STREET</sub> =	0.016	

Max. Allowable Spread for Minor & Major Storm  
Max. Allowable Depth at Gutter Flowline for Minor & Major Storm  
Allow Flow Depth at Street Crown (leave blank for no)

	Minor Storm	Major Storm	
T <sub>MAX</sub> =	13.0	13.0	ft
d <sub>MAX</sub> =	6.0	12.0	inches
	<input type="checkbox"/>	<input checked="" type="checkbox"/>	check = yes

**Maximum Capacity for 1/2 Street based On Allowable Spread**

Water Depth without Gutter Depression (Eq. ST-2)  
Vertical Depth between Gutter Lip and Gutter Flowline (usually 2")  
Gutter Depression (d<sub>c</sub> - (W \* S<sub>x</sub> \* 12))  
Water Depth at Gutter Flowline  
Allowable Spread for Discharge outside the Gutter Section W (T - W)  
Gutter Flow to Design Flow Ratio by FHWA HEC-22 method (Eq. ST-7)  
Discharge outside the Gutter Section W, carried in Section T<sub>x</sub>  
Discharge within the Gutter Section W (Q<sub>T</sub> - Q<sub>x</sub>)  
Discharge Behind the Curb (e.g., sidewalk, driveways, & lawns)

	Minor Storm	Major Storm	
y =	3.12	3.12	inches
d <sub>c</sub> =	2.0	2.0	inches
a =	1.51	1.51	inches
d =	4.63	4.63	inches
T <sub>x</sub> =	11.0	11.0	ft
E <sub>0</sub> =	0.456	0.456	
Q <sub>x</sub> =	4.4	4.4	cfs
Q <sub>w</sub> =	3.7	3.7	cfs
Q <sub>BACK</sub> =	0.0	0.0	cfs
Q <sub>T</sub> =	8.0	8.0	cfs
V =	6.0	6.0	fps
V*d =	2.3	2.3	

**Maximum Flow Based On Allowable Spread**

Flow Velocity within the Gutter Section

V\*d Product: Flow Velocity times Gutter Flowline Depth

**Maximum Capacity for 1/2 Street based on Allowable Depth**

Theoretical Water Spread  
Theoretical Spread for Discharge outside the Gutter Section W (T - W)  
Gutter Flow to Design Flow Ratio by FHWA HEC-22 method (Eq. ST-7)  
Theoretical Discharge outside the Gutter Section W, carried in Section T<sub>xTH</sub>  
Actual Discharge outside the Gutter Section W, (limited by distance T<sub>CROWN</sub>)  
Discharge within the Gutter Section W (Q<sub>d</sub> - Q<sub>x</sub>)  
Discharge Behind the Curb (e.g., sidewalk, driveways, & lawns)  
Total Discharge for Major & Minor Storm (Pre-Safety Factor)  
Average Flow Velocity Within the Gutter Section  
V\*d Product: Flow Velocity Times Gutter Flowline Depth  
Slope-Based Depth Safety Reduction Factor for Major & Minor (d ≥ 6") Storm

	Minor Storm	Major Storm	
T <sub>TH</sub> =	18.7	43.7	ft
T <sub>xTH</sub> =	16.7	41.7	ft
E <sub>0</sub> =	0.318	0.130	
Q <sub>xTH</sub> =	13.3	152.5	cfs
Q <sub>x</sub> =	12.5	85.1	cfs
Q <sub>w</sub> =	6.2	22.9	cfs
Q <sub>BACK</sub> =	0.0	14.0	cfs
Q =	18.7	122.0	cfs
V =	7.4	12.5	fps
V*d =	3.7	12.5	
R =	1.00	0.83	
Q <sub>d</sub> =	18.7	101.8	cfs
d =	6.00	11.13	inches
d <sub>CROWN</sub> =	1.37	6.50	inches

**Max Flow Based on Allowable Depth (Safety Factor Applied)**

Resultant Flow Depth at Gutter Flowline (Safety Factor Applied)

Resultant Flow Depth at Street Crown (Safety Factor Applied)

	Minor Storm	Major Storm	
Q <sub>allow</sub> =	8.0	101.8	cfs

**MINOR STORM Allowable Capacity is based on Spread Criterion**

**MAJOR STORM Allowable Capacity is based on Depth Criterion**

**Minor storm max. allowable capacity GOOD - greater than the design flow given on sheet 'Inlet Management'**

**Major storm max. allowable capacity GOOD - greater than the design flow given on sheet 'Inlet Management'**

**ALLOWABLE CAPACITY FOR ONE-HALF OF STREET (Minor & Major Storm)**

(Based on Regulated Criteria for Maximum Allowable Flow Depth and Spread)

Project: **CHAMBERS AND HESS**  
 Inlet ID: **DRIVE A STREET CAPACITY**

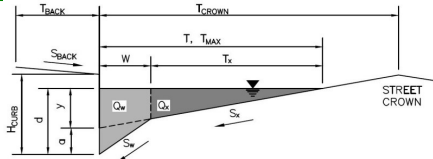

**Gutter Geometry (Enter data in the blue cells)**

Maximum Allowable Width for Spread Behind Curb  
 Side Slope Behind Curb (leave blank for no conveyance credit behind curb)  
 Manning's Roughness Behind Curb (typically between 0.012 and 0.020)

$T_{BACK} = 5.0$  ft  
 $S_{BACK} = 0.020$  ft/ft  
 $n_{BACK} = 0.020$

Height of Curb at Gutter Flow Line  
 Distance from Curb Face to Street Crown  
 Gutter Width  
 Street Transverse Slope  
 Gutter Cross Slope (typically 2 inches over 24 inches or 0.083 ft/ft)  
 Street Longitudinal Slope - Enter 0 for sump condition  
 Manning's Roughness for Street Section (typically between 0.012 and 0.020)

$H_{CURB} = 6.00$  inches  
 $T_{CROWN} = 13.0$  ft  
 $W = 2.00$  ft  
 $S_X = 0.020$  ft/ft  
 $S_W = 0.083$  ft/ft  
 $S_Y = 0.030$  ft/ft  
 $n_{STREET} = 0.016$

Max. Allowable Spread for Minor & Major Storm  
 Max. Allowable Depth at Gutter Flowline for Minor & Major Storm  
 Allow Flow Depth at Street Crown (leave blank for no)

	Minor Storm	Major Storm	
$T_{MAX}$	13.0	13.0	ft
$d_{MAX}$	6.0	12.0	inches
	<input type="checkbox"/>	<input checked="" type="checkbox"/>	check = yes

**Maximum Capacity for 1/2 Street based On Allowable Spread**

Water Depth without Gutter Depression (Eq. ST-2)  
 Vertical Depth between Gutter Lip and Gutter Flowline (usually 2")  
 Gutter Depression ( $d_c - (W * S_x * 12)$ )  
 Water Depth at Gutter Flowline  
 Allowable Spread for Discharge outside the Gutter Section W (T - W)  
 Gutter Flow to Design Flow Ratio by FHWA HEC-22 method (Eq. ST-7)  
 Discharge outside the Gutter Section W, carried in Section  $T_x$   
 Discharge within the Gutter Section W ( $Q_T - Q_x$ )  
 Discharge Behind the Curb (e.g., sidewalk, driveways, & lawns)

	Minor Storm	Major Storm	
y	3.12	3.12	inches
$d_c$	2.0	2.0	inches
a	1.51	1.51	inches
d	4.63	4.63	inches
$T_x$	11.0	11.0	ft
$E_o$	0.456	0.456	
$Q_x$	5.3	5.3	cfs
$Q_W$	4.5	4.5	cfs
$Q_{BACK}$	0.0	0.0	cfs
$Q_T$	9.8	9.8	cfs
V	7.4	7.4	fps
$V*d$	2.9	2.9	

**Maximum Flow Based On Allowable Spread**

Flow Velocity within the Gutter Section  
 $V*d$  Product: Flow Velocity times Gutter Flowline Depth

**Maximum Capacity for 1/2 Street based on Allowable Depth**

Theoretical Water Spread  
 Theoretical Spread for Discharge outside the Gutter Section W (T - W)  
 Gutter Flow to Design Flow Ratio by FHWA HEC-22 method (Eq. ST-7)  
 Theoretical Discharge outside the Gutter Section W, carried in Section  $T_{XTH}$   
 Actual Discharge outside the Gutter Section W, (limited by distance  $T_{CROWN}$ )  
 Discharge within the Gutter Section W ( $Q_d - Q_x$ )  
 Discharge Behind the Curb (e.g., sidewalk, driveways, & lawns)  
 Total Discharge for Major & Minor Storm (Pre-Safety Factor)  
 Average Flow Velocity Within the Gutter Section  
 $V*d$  Product: Flow Velocity Times Gutter Flowline Depth  
 Slope-Based Depth Safety Reduction Factor for Major & Minor ( $d \geq 6"$ ) Storm

	Minor Storm	Major Storm	
$T_{TH}$	18.7	43.7	ft
$T_{XTH}$	16.7	41.7	ft
$E_o$	0.318	0.130	
$Q_{XTH}$	16.3	186.8	cfs
$Q_x$	15.4	104.2	cfs
$Q_W$	7.6	28.0	cfs
$Q_{BACK}$	0.0	17.1	cfs
Q	22.9	149.4	cfs
V	9.1	15.3	fps
$V*d$	4.5	15.3	
R	0.74	0.60	
$Q_d$	17.1	90.1	cfs
d	5.46	9.77	inches
$d_{CROWN}$	0.83	5.14	inches

**Max Flow Based on Allowable Depth (Safety Factor Applied)**

Resultant Flow Depth at Gutter Flowline (Safety Factor Applied)  
 Resultant Flow Depth at Street Crown (Safety Factor Applied)

	Minor Storm	Major Storm	
$Q_{allow}$	9.8	90.1	cfs

**MINOR STORM Allowable Capacity is based on Spread Criterion**

**MAJOR STORM Allowable Capacity is based on Depth Criterion**

**Minor storm max. allowable capacity GOOD - greater than the design flow given on sheet 'Inlet Management'**  
**Major storm max. allowable capacity GOOD - greater than the design flow given on sheet 'Inlet Management'**

**ALLOWABLE CAPACITY FOR ONE-HALF OF STREET (Minor & Major Storm)**

(Based on Regulated Criteria for Maximum Allowable Flow Depth and Spread)

Project:  
Inlet ID:

**CHAMBERS AND HESS  
DRIVE A STREET CAPACITY**

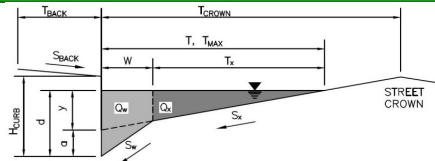

**Gutter Geometry (Enter data in the blue cells)**

Maximum Allowable Width for Spread Behind Curb  
Side Slope Behind Curb (leave blank for no conveyance credit behind curb)  
Manning's Roughness Behind Curb (typically between 0.012 and 0.020)

T<sub>BACK</sub> = 5.0 ft  
S<sub>BACK</sub> = 0.020 ft/ft  
n<sub>BACK</sub> = 0.020

Height of Curb at Gutter Flow Line  
Distance from Curb Face to Street Crown  
Gutter Width  
Street Transverse Slope  
Gutter Cross Slope (typically 2 inches over 24 inches or 0.083 ft/ft)  
Street Longitudinal Slope - Enter 0 for sump condition  
Manning's Roughness for Street Section (typically between 0.012 and 0.020)

H<sub>CURB</sub> = 6.00 inches  
T<sub>CROWN</sub> = 13.0 ft  
W = 2.00 ft  
S<sub>X</sub> = 0.020 ft/ft  
S<sub>W</sub> = 0.083 ft/ft  
S<sub>O</sub> = 0.040 ft/ft  
n<sub>STREET</sub> = 0.016

Max. Allowable Spread for Minor & Major Storm  
Max. Allowable Depth at Gutter Flowline for Minor & Major Storm  
Allow Flow Depth at Street Crown (leave blank for no)

	Minor Storm	Major Storm	
T <sub>MAX</sub>	13.0	13.0	ft
d <sub>MAX</sub>	6.0	12.0	inches
	<input type="checkbox"/>	<input checked="" type="checkbox"/>	check = yes

**Maximum Capacity for 1/2 Street based On Allowable Spread**

Water Depth without Gutter Depression (Eq. ST-2)  
Vertical Depth between Gutter Lip and Gutter Flowline (usually 2")  
Gutter Depression (d<sub>c</sub> - (W \* S<sub>x</sub> \* 12))  
Water Depth at Gutter Flowline  
Allowable Spread for Discharge outside the Gutter Section W (T - W)  
Gutter Flow to Design Flow Ratio by FHWA HEC-22 method (Eq. ST-7)  
Discharge outside the Gutter Section W, carried in Section T<sub>x</sub>  
Discharge within the Gutter Section W (Q<sub>T</sub> - Q<sub>x</sub>)  
Discharge Behind the Curb (e.g., sidewalk, driveways, & lawns)

	Minor Storm	Major Storm	
y	3.12	3.12	inches
d <sub>c</sub>	2.0	2.0	inches
a	1.51	1.51	inches
d	4.63	4.63	inches
T <sub>x</sub>	11.0	11.0	ft
E <sub>0</sub>	0.456	0.456	
Q <sub>x</sub>	6.2	6.2	cfs
Q <sub>w</sub>	5.2	5.2	cfs
Q <sub>BACK</sub>	0.0	0.0	cfs
Q <sub>T</sub>	11.3	11.3	cfs
V	8.5	8.5	fps
V*d	3.3	3.3	

**Maximum Flow Based On Allowable Spread**

Flow Velocity within the Gutter Section  
V\*d Product: Flow Velocity times Gutter Flowline Depth

**Maximum Capacity for 1/2 Street based on Allowable Depth**

Theoretical Water Spread  
Theoretical Spread for Discharge outside the Gutter Section W (T - W)  
Gutter Flow to Design Flow Ratio by FHWA HEC-22 method (Eq. ST-7)  
Theoretical Discharge outside the Gutter Section W, carried in Section T<sub>xTH</sub>  
Actual Discharge outside the Gutter Section W, (limited by distance T<sub>CROWN</sub>)  
Discharge within the Gutter Section W (Q<sub>d</sub> - Q<sub>x</sub>)  
Discharge Behind the Curb (e.g., sidewalk, driveways, & lawns)  
Total Discharge for Major & Minor Storm (Pre-Safety Factor)  
Average Flow Velocity Within the Gutter Section  
V\*d Product: Flow Velocity Times Gutter Flowline Depth  
Slope-Based Depth Safety Reduction Factor for Major & Minor (d ≥ 6") Storm

	Minor Storm	Major Storm	
T <sub>TH</sub>	18.7	43.7	ft
T <sub>xTH</sub>	16.7	41.7	ft
E <sub>0</sub>	0.318	0.130	
Q <sub>xTH</sub>	18.8	215.7	cfs
Q <sub>x</sub>	17.7	120.4	cfs
Q <sub>w</sub>	8.8	32.4	cfs
Q <sub>BACK</sub>	0.0	19.8	cfs
Q	26.5	172.5	cfs
V	10.5	17.6	fps
V*d	5.2	17.6	
R	0.59	0.48	
Q <sub>d</sub>	15.7	82.7	cfs
d	5.09	8.95	inches
d <sub>CROWN</sub>	0.46	4.32	inches

**Max Flow Based on Allowable Depth (Safety Factor Applied)**

Resultant Flow Depth at Gutter Flowline (Safety Factor Applied)  
Resultant Flow Depth at Street Crown (Safety Factor Applied)

MINOR STORM Allowable Capacity is based on Spread Criterion

MAJOR STORM Allowable Capacity is based on Depth Criterion

	Minor Storm	Major Storm	
Q <sub>allow</sub>	11.3	82.7	cfs

Minor storm max. allowable capacity GOOD - greater than the design flow given on sheet 'Inlet Management'  
Major storm max. allowable capacity GOOD - greater than the design flow given on sheet 'Inlet Management'

**ALLOWABLE CAPACITY FOR ONE-HALF OF STREET (Minor & Major Storm)**

(Based on Regulated Criteria for Maximum Allowable Flow Depth and Spread)

Project: **CHAMBERS AND HESS**  
 Inlet ID: **DRIVE A STREET CAPACITY**

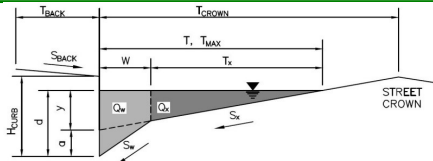

**Gutter Geometry (Enter data in the blue cells)**

Maximum Allowable Width for Spread Behind Curb  
 Side Slope Behind Curb (leave blank for no conveyance credit behind curb)  
 Manning's Roughness Behind Curb (typically between 0.012 and 0.020)

T <sub>BACK</sub> =	5.0	ft
S <sub>BACK</sub> =	0.020	ft/ft
n <sub>BACK</sub> =	0.020	

Height of Curb at Gutter Flow Line  
 Distance from Curb Face to Street Crown  
 Gutter Width  
 Street Transverse Slope  
 Gutter Cross Slope (typically 2 inches over 24 inches or 0.083 ft/ft)  
 Street Longitudinal Slope - Enter 0 for sump condition  
 Manning's Roughness for Street Section (typically between 0.012 and 0.020)

H <sub>CURB</sub> =	6.00	inches
T <sub>CROWN</sub> =	13.0	ft
W =	2.00	ft
S <sub>X</sub> =	0.020	ft/ft
S <sub>W</sub> =	0.083	ft/ft
S <sub>O</sub> =	0.050	ft/ft
n <sub>STREET</sub> =	0.016	

Max. Allowable Spread for Minor & Major Storm  
 Max. Allowable Depth at Gutter Flowline for Minor & Major Storm  
 Allow Flow Depth at Street Crown (leave blank for no)

	Minor Storm	Major Storm	
T <sub>MAX</sub> =	13.0	13.0	ft
d <sub>MAX</sub> =	6.0	12.0	inches
	<input type="checkbox"/>	<input checked="" type="checkbox"/>	check = yes

**Maximum Capacity for 1/2 Street based On Allowable Spread**

Water Depth without Gutter Depression (Eq. ST-2)  
 Vertical Depth between Gutter Lip and Gutter Flowline (usually 2")  
 Gutter Depression (d<sub>c</sub> - (W \* S<sub>x</sub> \* 12))  
 Water Depth at Gutter Flowline  
 Allowable Spread for Discharge outside the Gutter Section W (T - W)  
 Gutter Flow to Design Flow Ratio by FHWA HEC-22 method (Eq. ST-7)  
 Discharge outside the Gutter Section W, carried in Section T<sub>x</sub>  
 Discharge within the Gutter Section W (Q<sub>T</sub> - Q<sub>X</sub>)  
 Discharge Behind the Curb (e.g., sidewalk, driveways, & lawns)

	Minor Storm	Major Storm	
y =	3.12	3.12	inches
d <sub>c</sub> =	2.0	2.0	inches
a =	1.51	1.51	inches
d =	4.63	4.63	inches
T <sub>X</sub> =	11.0	11.0	ft
E <sub>O</sub> =	0.456	0.456	
Q <sub>X</sub> =	6.9	6.9	cfs
Q <sub>W</sub> =	5.8	5.8	cfs
Q <sub>BACK</sub> =	0.0	0.0	cfs
Q <sub>T</sub> =	12.7	12.7	cfs
V =	9.5	9.5	fps
V*d =	3.7	3.7	

**Maximum Flow Based On Allowable Spread**

Flow Velocity within the Gutter Section

V\*d Product: Flow Velocity times Gutter Flowline Depth

**Maximum Capacity for 1/2 Street based on Allowable Depth**

Theoretical Water Spread  
 Theoretical Spread for Discharge outside the Gutter Section W (T - W)  
 Gutter Flow to Design Flow Ratio by FHWA HEC-22 method (Eq. ST-7)  
 Theoretical Discharge outside the Gutter Section W, carried in Section T<sub>XTH</sub>  
 Actual Discharge outside the Gutter Section W, (limited by distance T<sub>CROWN</sub>)  
 Discharge within the Gutter Section W (Q<sub>d</sub> - Q<sub>X</sub>)  
 Discharge Behind the Curb (e.g., sidewalk, driveways, & lawns)  
 Total Discharge for Major & Minor Storm (Pre-Safety Factor)  
 Average Flow Velocity Within the Gutter Section  
 V\*d Product: Flow Velocity Times Gutter Flowline Depth  
 Slope-Based Depth Safety Reduction Factor for Major & Minor (d ≥ 6") Storm

	Minor Storm	Major Storm	
T <sub>TH</sub> =	18.7	43.7	ft
T <sub>XTH</sub> =	16.7	41.7	ft
E <sub>O</sub> =	0.318	0.130	
Q <sub>XTH</sub> =	21.0	241.2	cfs
Q <sub>X</sub> =	19.8	134.6	cfs
Q <sub>W</sub> =	9.8	36.2	cfs
Q <sub>BACK</sub> =	0.0	22.1	cfs
Q =	29.6	192.9	cfs
V =	11.7	19.7	fps
V*d =	5.9	19.7	
R =	0.49	0.40	
Q <sub>d</sub> =	14.6	77.3	cfs
d =	4.83	8.38	inches
d <sub>CROWN</sub> =	0.20	3.75	inches

**Max Flow Based on Allowable Depth (Safety Factor Applied)**

Resultant Flow Depth at Gutter Flowline (Safety Factor Applied)

Resultant Flow Depth at Street Crown (Safety Factor Applied)

	Minor Storm	Major Storm	
Q <sub>allow</sub> =	12.7	77.3	cfs

**MINOR STORM Allowable Capacity is based on Spread Criterion**

**MAJOR STORM Allowable Capacity is based on Depth Criterion**

**Minor storm max. allowable capacity GOOD - greater than the design flow given on sheet 'Inlet Management'**

**Major storm max. allowable capacity GOOD - greater than the design flow given on sheet 'Inlet Management'**

**ALLOWABLE CAPACITY FOR ONE-HALF OF STREET (Minor & Major Storm)**

(Based on Regulated Criteria for Maximum Allowable Flow Depth and Spread)

Project: **CHAMBERS AND HESS**  
 Inlet ID: **DRIVE A AND ALLEY A STREET CAPACITY**

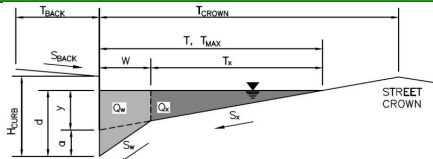

**Gutter Geometry (Enter data in the blue cells)**

Maximum Allowable Width for Spread Behind Curb  
 Side Slope Behind Curb (leave blank for no conveyance credit behind curb)  
 Manning's Roughness Behind Curb (typically between 0.012 and 0.020)

Height of Curb at Gutter Flow Line  
 Distance from Curb Face to Street Crown  
 Gutter Width  
 Street Transverse Slope  
 Gutter Cross Slope (typically 2 inches over 24 inches or 0.083 ft/ft)  
 Street Longitudinal Slope - Enter 0 for sump condition  
 Manning's Roughness for Street Section (typically between 0.012 and 0.020)

Max. Allowable Spread for Minor & Major Storm  
 Max. Allowable Depth at Gutter Flowline for Minor & Major Storm  
 Allow Flow Depth at Street Crown (leave blank for no)

$T_{BACK}$ =	5.0	ft
$S_{BACK}$ =	0.020	ft/ft
$n_{BACK}$ =	0.020	
$H_{CURB}$ =	6.00	inches
$T_{CROWN}$ =	14.0	ft
$W$ =	2.00	ft
$S_x$ =	0.020	ft/ft
$S_w$ =	0.083	ft/ft
$S_0$ =	0.060	ft/ft
$n_{STREET}$ =	0.016	

	Minor Storm	Major Storm	
$T_{MAX}$ =	14.0	14.0	ft
$d_{MAX}$ =	6.0	12.0	inches
	<input type="checkbox"/>	<input checked="" type="checkbox"/>	check = yes

**Maximum Capacity for 1/2 Street based On Allowable Spread**

Water Depth without Gutter Depression (Eq. ST-2)  
 Vertical Depth between Gutter Lip and Gutter Flowline (usually 2")  
 Gutter Depression ( $d_c - (W * S_x * 12)$ )  
 Water Depth at Gutter Flowline  
 Allowable Spread for Discharge outside the Gutter Section W (T - W)  
 Gutter Flow to Design Flow Ratio by FHWA HEC-22 method (Eq. ST-7)  
 Discharge outside the Gutter Section W, carried in Section  $T_x$   
 Discharge within the Gutter Section W ( $Q_T - Q_x$ )  
 Discharge Behind the Curb (e.g., sidewalk, driveways, & lawns)

**Maximum Flow Based On Allowable Spread**

Flow Velocity within the Gutter Section  
 $V*d$  Product: Flow Velocity times Gutter Flowline Depth

	Minor Storm	Major Storm	
$y$ =	3.36	3.36	inches
$d_c$ =	2.0	2.0	inches
$a$ =	1.51	1.51	inches
$d$ =	4.87	4.87	inches
$T_x$ =	12.0	12.0	ft
$E_0$ =	0.425	0.425	
$Q_x$ =	9.5	9.5	cfs
$Q_w$ =	7.0	7.0	cfs
$Q_{BACK}$ =	0.0	0.0	cfs
$Q_T$ =	16.6	16.6	cfs
$V$ =	10.9	10.9	fps
$V*d$ =	4.4	4.4	

**Maximum Capacity for 1/2 Street based on Allowable Depth**

Theoretical Water Spread  
 Theoretical Spread for Discharge outside the Gutter Section W (T - W)  
 Gutter Flow to Design Flow Ratio by FHWA HEC-22 method (Eq. ST-7)  
 Theoretical Discharge outside the Gutter Section W, carried in Section  $T_{XTH}$   
 Actual Discharge outside the Gutter Section W, (limited by distance  $T_{CROWN}$ )  
 Discharge within the Gutter Section W ( $Q_d - Q_x$ )  
 Discharge Behind the Curb (e.g., sidewalk, driveways, & lawns)  
 Total Discharge for Major & Minor Storm (Pre-Safety Factor)  
 Average Flow Velocity Within the Gutter Section  
 $V*d$  Product: Flow Velocity Times Gutter Flowline Depth  
 Slope-Based Depth Safety Reduction Factor for Major & Minor ( $d \geq 6"$ ) Storm

**Max Flow Based on Allowable Depth (Safety Factor Applied)**

Resultant Flow Depth at Gutter Flowline (Safety Factor Applied)  
 Resultant Flow Depth at Street Crown (Safety Factor Applied)

	Minor Storm	Major Storm	
$T_{TH}$ =	18.7	43.7	ft
$T_{XTH}$ =	16.7	41.7	ft
$E_0$ =	0.318	0.130	
$Q_{XTH}$ =	23.0	264.2	cfs
$Q_x$ =	22.2	157.3	cfs
$Q_w$ =	10.7	39.6	cfs
$Q_{BACK}$ =	0.0	24.2	cfs
$Q$ =	33.0	221.2	cfs
$V$ =	12.9	21.6	fps
$V*d$ =	6.4	21.6	
$R$ =	0.43	0.35	
$Q_d$ =	14.1	76.6	cfs
$d$ =	4.65	7.98	inches
$d_{CROWN}$ =	0.00	3.11	inches

**MINOR STORM Allowable Capacity is based on Depth Criterion**  
**MAJOR STORM Allowable Capacity is based on Depth Criterion**

	Minor Storm	Major Storm	
$Q_{allow}$ =	14.1	76.6	cfs

**Minor storm max. allowable capacity GOOD - greater than the design flow given on sheet 'Inlet Management'**  
**Major storm max. allowable capacity GOOD - greater than the design flow given on sheet 'Inlet Management'**

### Drive A Minor Storm Street Capacity

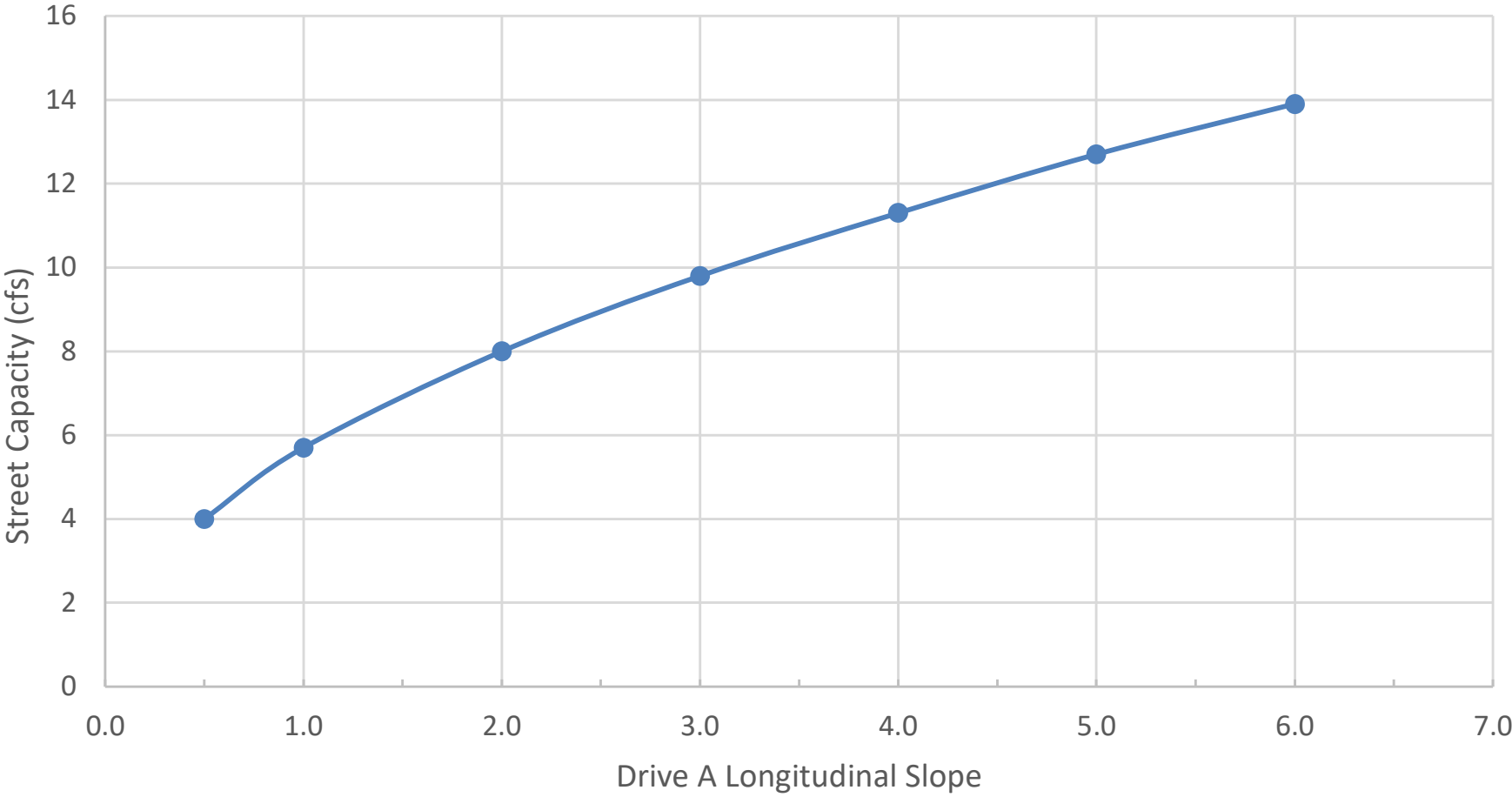

SEE THE PREVIOUS PAGES FOR THE STREET CAPACITY CALCULATIONS AT VARIOUS LONGITUDINAL SLOPES

**ALLOWABLE CAPACITY FOR ONE-HALF OF STREET (Minor & Major Storm)**

(Based on Regulated Criteria for Maximum Allowable Flow Depth and Spread)

Project:

CHAMBERS AND HESS

Inlet ID:

INLET 11 (DP 9)

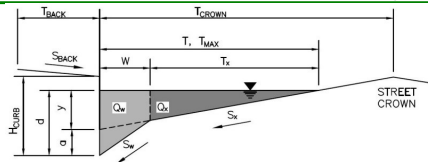

**Gutter Geometry (Enter data in the blue cells)**

Maximum Allowable Width for Spread Behind Curb  
 Side Slope Behind Curb (leave blank for no conveyance credit behind curb)  
 Manning's Roughness Behind Curb (typically between 0.012 and 0.020)

$T_{BACK} = 5.0$  ft  
 $S_{BACK} = 0.020$  ft/ft  
 $n_{BACK} = 0.020$

Height of Curb at Gutter Flow Line  
 Distance from Curb Face to Street Crown  
 Gutter Width  
 Street Transverse Slope  
 Gutter Cross Slope (typically 2 inches over 24 inches or 0.083 ft/ft)  
 Street Longitudinal Slope - Enter 0 for sump condition  
 Manning's Roughness for Street Section (typically between 0.012 and 0.020)

$H_{CURB} = 6.00$  inches  
 $T_{CROWN} = 13.0$  ft  
 $W = 2.00$  ft  
 $S_x = 0.020$  ft/ft  
 $S_w = 0.083$  ft/ft  
 $S_o = 0.000$  ft/ft  
 $n_{STREET} = 0.016$

Max. Allowable Spread for Minor & Major Storm  
 Max. Allowable Depth at Gutter Flowline for Minor & Major Storm  
 Check boxes are not applicable in SUMP conditions

	Minor Storm	Major Storm	
$T_{MAX} =$	13.0	13.0	ft
$d_{MAX} =$	6.0	12.0	inches
	<input type="checkbox"/>	<input type="checkbox"/>	

**MINOR STORM Allowable Capacity is based on Depth Criterion**  
**MAJOR STORM Allowable Capacity is based on Depth Criterion**

$Q_{allow} =$ 

Minor Storm	Major Storm
SUMP	SUMP

 cfs

## INLET IN A SUMP OR SAG LOCATION

Version 4.05 Released March 2017

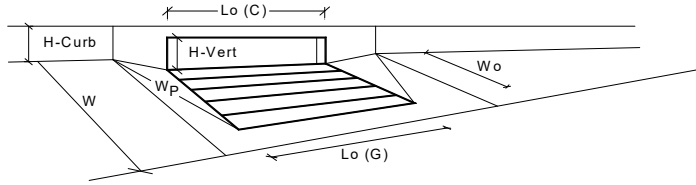

Design Information (Input)	MINOR	MAJOR	
Type of Inlet	CDOT Type R Curb Opening		
Local Depression (additional to continuous gutter depression 'a' from above)	3.00	3.00	inches
Number of Unit Inlets (Grate or Curb Opening)	1	1	
Water Depth at Flowline (outside of local depression)	4.6	9.2	inches
<b>Grate Information</b>	MINOR	MAJOR	<input checked="" type="checkbox"/> Override Depths
Length of a Unit Grate	N/A	N/A	feet
Width of a Unit Grate	N/A	N/A	feet
Area Opening Ratio for a Grate (typical values 0.15-0.90)	N/A	N/A	
Clogging Factor for a Single Grate (typical value 0.50 - 0.70)	N/A	N/A	
Grate Weir Coefficient (typical value 2.15 - 3.60)	N/A	N/A	
Grate Orifice Coefficient (typical value 0.60 - 0.80)	N/A	N/A	
<b>Curb Opening Information</b>	MINOR	MAJOR	
Length of a Unit Curb Opening	5.00	5.00	feet
Height of Vertical Curb Opening in Inches	6.00	6.00	inches
Height of Curb Orifice Throat in Inches	6.00	6.00	inches
Angle of Throat (see USDCM Figure ST-5)	63.40	63.40	degrees
Side Width for Depression Pan (typically the gutter width of 2 feet)	2.00	2.00	feet
Clogging Factor for a Single Curb Opening (typical value 0.10)	0.10	0.10	
Curb Opening Weir Coefficient (typical value 2.3-3.7)	3.60	3.60	
Curb Opening Orifice Coefficient (typical value 0.60 - 0.70)	0.67	0.67	
<b>Grate Flow Analysis (Calculated)</b>	MINOR	MAJOR	
Clogging Coefficient for Multiple Units	N/A	N/A	
Clogging Factor for Multiple Units	N/A	N/A	
<b>Grate Capacity as a Weir (based on Modified HEC22 Method)</b>	MINOR	MAJOR	
Interception without Clogging	N/A	N/A	cfs
Interception with Clogging	N/A	N/A	cfs
<b>Grate Capacity as an Orifice (based on Modified HEC22 Method)</b>	MINOR	MAJOR	
Interception without Clogging	N/A	N/A	cfs
Interception with Clogging	N/A	N/A	cfs
<b>Grate Capacity as Mixed Flow</b>	MINOR	MAJOR	
Interception without Clogging	N/A	N/A	cfs
Interception with Clogging	N/A	N/A	cfs
<b>Resulting Grate Capacity (assumes clogged condition)</b>	N/A	N/A	cfs
<b>Curb Opening Flow Analysis (Calculated)</b>	MINOR	MAJOR	
Clogging Coefficient for Multiple Units	1.00	1.00	
Clogging Factor for Multiple Units	0.10	0.10	
<b>Curb Opening as a Weir (based on Modified HEC22 Method)</b>	MINOR	MAJOR	
Interception without Clogging	3.1	14.4	cfs
Interception with Clogging	2.8	13.0	cfs
<b>Curb Opening as an Orifice (based on Modified HEC22 Method)</b>	MINOR	MAJOR	
Interception without Clogging	8.6	12.0	cfs
Interception with Clogging	7.7	10.8	cfs
<b>Curb Opening Capacity as Mixed Flow</b>	MINOR	MAJOR	
Interception without Clogging	4.8	12.2	cfs
Interception with Clogging	4.3	11.0	cfs
<b>Resulting Curb Opening Capacity (assumes clogged condition)</b>	2.8	10.8	cfs
<b>Resultant Street Conditions</b>	MINOR	MAJOR	
Total Inlet Length	5.00	5.00	feet
Resultant Street Flow Spread (based on street geometry from above)	12.9	32.0	ft.>T-Crown
Resultant Flow Depth at Street Crown	0.0	4.6	inches
<b>Low Head Performance Reduction (Calculated)</b>	MINOR	MAJOR	
Depth for Grate Midwidth	N/A	N/A	ft
Depth for Curb Opening Weir Equation	0.22	0.60	ft
Combination Inlet Performance Reduction Factor for Long Inlets	0.59	1.00	
Curb Opening Performance Reduction Factor for Long Inlets	1.00	1.00	
Grated Inlet Performance Reduction Factor for Long Inlets	N/A	N/A	
<b>Total Inlet Interception Capacity (assumes clogged condition)</b>	2.8	10.8	cfs
<b>Inlet Capacity IS GOOD for Minor and Major Storms(&gt;Q PEAK)</b>	2.4	8.2	cfs

**ALLOWABLE CAPACITY FOR ONE-HALF OF STREET (Minor & Major Storm)**

(Based on Regulated Criteria for Maximum Allowable Flow Depth and Spread)

Project:

CHAMBERS AND HESS

Inlet ID:

INLET 16 (DP10)

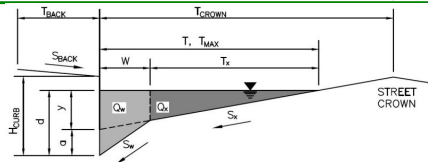

**Gutter Geometry (Enter data in the blue cells)**

Maximum Allowable Width for Spread Behind Curb  
 Side Slope Behind Curb (leave blank for no conveyance credit behind curb)  
 Manning's Roughness Behind Curb (typically between 0.012 and 0.020)

$T_{BACK} = 5.0$  ft  
 $S_{BACK} = 0.020$  ft/ft  
 $n_{BACK} = 0.020$

Height of Curb at Gutter Flow Line  
 Distance from Curb Face to Street Crown  
 Gutter Width  
 Street Transverse Slope  
 Gutter Cross Slope (typically 2 inches over 24 inches or 0.083 ft/ft)  
 Street Longitudinal Slope - Enter 0 for sump condition  
 Manning's Roughness for Street Section (typically between 0.012 and 0.020)

$H_{CURB} = 6.00$  inches  
 $T_{CROWN} = 13.0$  ft  
 $W = 2.00$  ft  
 $S_X = 0.020$  ft/ft  
 $S_W = 0.083$  ft/ft  
 $S_O = 0.000$  ft/ft  
 $n_{STREET} = 0.016$

Max. Allowable Spread for Minor & Major Storm  
 Max. Allowable Depth at Gutter Flowline for Minor & Major Storm  
 Check boxes are not applicable in SUMP conditions

	Minor Storm	Major Storm	
$T_{MAX} =$	13.0	13.0	ft
$d_{MAX} =$	6.0	12.0	inches
	<input type="checkbox"/>	<input type="checkbox"/>	

MINOR STORM Allowable Capacity is based on Depth Criterion  
 MAJOR STORM Allowable Capacity is based on Depth Criterion

$Q_{allow} =$ 

Minor Storm	Major Storm	
SUMP	SUMP	cfs

## INLET IN A SUMP OR SAG LOCATION

Version 4.05 Released March 2017

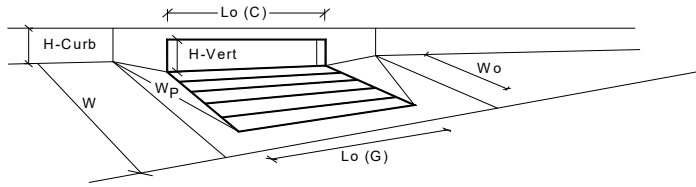

		MINOR	MAJOR	
<b>Design Information (Input)</b>				
Type of Inlet	<input type="text" value="CDOT Type R Curb Opening"/>			
Local Depression (additional to continuous gutter depression 'a' from above)		Type =	CDOT Type R Curb Opening	
Number of Unit Inlets (Grate or Curb Opening)		$a_{local}$ =	3.00	3.00 inches
Water Depth at Flowline (outside of local depression)		No =	3	3
<b>Grate Information</b>		Ponding Depth =	3.6	9.0 inches
Length of a Unit Grate				<input checked="" type="checkbox"/> Override Depths
Width of a Unit Grate		$L_o$ (G) =	N/A	N/A feet
Area Opening Ratio for a Grate (typical values 0.15-0.90)		$W_o$ =	N/A	N/A feet
Clogging Factor for a Single Grate (typical value 0.50 - 0.70)		$A_{ratio}$ =	N/A	N/A
Grate Weir Coefficient (typical value 2.15 - 3.60)		$C_r$ (G) =	N/A	N/A
Grate Orifice Coefficient (typical value 0.60 - 0.80)		$C_w$ (G) =	N/A	N/A
<b>Curb Opening Information</b>		$C_o$ (G) =	N/A	N/A
Length of a Unit Curb Opening				
Height of Vertical Curb Opening in Inches		$L_o$ (C) =	5.00	5.00 feet
Height of Curb Orifice Throat in Inches		$H_{vert}$ =	6.00	6.00 inches
Angle of Throat (see USDCM Figure ST-5)		$H_{throat}$ =	6.00	6.00 inches
Side Width for Depression Pan (typically the gutter width of 2 feet)		Throat =	63.40	63.40 degrees
Clogging Factor for a Single Curb Opening (typical value 0.10)		$W_p$ =	2.00	2.00 feet
Curb Opening Weir Coefficient (typical value 2.3-3.7)		$C_r$ (C) =	0.10	0.10
Curb Opening Orifice Coefficient (typical value 0.60 - 0.70)		$C_w$ (C) =	3.60	3.60
		$C_o$ (C) =	0.67	0.67
<b>Grate Flow Analysis (Calculated)</b>				
Clogging Coefficient for Multiple Units		Coef =	N/A	N/A
Clogging Factor for Multiple Units		Clog =	N/A	N/A
<b>Grate Capacity as a Weir (based on Modified HEC22 Method)</b>				
Interception without Clogging		$Q_{wi}$ =	N/A	N/A cfs
Interception with Clogging		$Q_{wa}$ =	N/A	N/A cfs
<b>Grate Capacity as an Orifice (based on Modified HEC22 Method)</b>				
Interception without Clogging		$Q_{oi}$ =	N/A	N/A cfs
Interception with Clogging		$Q_{oa}$ =	N/A	N/A cfs
<b>Grate Capacity as Mixed Flow</b>				
Interception without Clogging		$Q_{mi}$ =	N/A	N/A cfs
Interception with Clogging		$Q_{ma}$ =	N/A	N/A cfs
<b>Resulting Grate Capacity (assumes clogged condition)</b>		$Q_{Grate}$ =	N/A	N/A cfs
<b>Curb Opening Flow Analysis (Calculated)</b>				
Clogging Coefficient for Multiple Units		Coef =	1.31	1.31
Clogging Factor for Multiple Units		Clog =	0.04	0.04
<b>Curb Opening as a Weir (based on Modified HEC22 Method)</b>				
Interception without Clogging		$Q_{wi}$ =	2.7	38.7 cfs
Interception with Clogging		$Q_{wa}$ =	2.6	37.0 cfs
<b>Curb Opening as an Orifice (based on Modified HEC22 Method)</b>				
Interception without Clogging		$Q_{oi}$ =	23.0	35.5 cfs
Interception with Clogging		$Q_{oa}$ =	22.0	34.0 cfs
<b>Curb Opening Capacity as Mixed Flow</b>				
Interception without Clogging		$Q_{mi}$ =	7.4	34.5 cfs
Interception with Clogging		$Q_{ma}$ =	7.1	33.0 cfs
<b>Resulting Curb Opening Capacity (assumes clogged condition)</b>		$Q_{Curb}$ =	2.6	33.0 cfs
<b>Resultant Street Conditions</b>				
Total Inlet Length		L =	15.00	15.00 feet
Resultant Street Flow Spread (based on street geometry from above)		T =	8.7	31.2 ft.>T-Crown
Resultant Flow Depth at Street Crown		$d_{crown}$ =	0.0	4.4 inches
<b>Low Head Performance Reduction (Calculated)</b>				
Depth for Grate Midwidth		$d_{Grate}$ =	N/A	N/A ft
Depth for Curb Opening Weir Equation		$d_{Curb}$ =	0.13	0.58 ft
Combination Inlet Performance Reduction Factor for Long Inlets		$RF_{Combination}$ =	0.34	0.85
Curb Opening Performance Reduction Factor for Long Inlets		$RF_{Curb}$ =	0.60	0.93
Grated Inlet Performance Reduction Factor for Long Inlets		$RF_{Grate}$ =	N/A	N/A
<b>Total Inlet Interception Capacity (assumes clogged condition)</b>				
		$Q_s$ =	2.6	33.0 cfs
<b>Inlet Capacity IS GOOD for Minor and Major Storms(&gt;Q PEAK)</b>		$Q_{PEAK REQUIRED}$ =	1.6	4.3 cfs



**PROJECT: CHAMBERS AND HESS FILING NO. 1**  
**SUBJECT: INLET DESIGNS**

**JOB #: D01173**  
**DATE: 10/22/2020**  
**BY: BHE**

Determine Head Required to capture the runoff

Commercial Lot 1

Design Q= 6.4 cfs  
CDOT Type C  
Area= 3.15 ft<sup>2</sup>  
Perimeter= 6 ft

Orifice Equation=> solve for H (Eq 2)  
h (ft)= 0.18

Weir Equation=> solve for H (Eq 4)  
h (ft)= 0.50

Larger h Controls: 0.50 ft of Head required to capture 100% of runoff

---

Commercial Lot 2

Design Q= 4.6 cfs  
CDOT Type C  
Area= 3.15 ft<sup>2</sup>  
Perimeter= 6 ft

Orifice Equation=> solve for H (Eq 2)  
h (ft)= 0.09

Weir Equation=> solve for H (Eq 4)  
h (ft)= 0.40

Larger h Controls: 0.40 ft of Head required to capture 100% of runoff

---

Commercial Lot 3

Design Q= 8.2 cfs  
CDOT Type C  
Area= 3.15 ft<sup>2</sup>  
Perimeter= 6 ft

Orifice Equation=> solve for H (Eq 2)  
h (ft)= 0.29

Weir Equation=> solve for H (Eq 4)  
h (ft)= 0.59

Larger h Controls: 0.59 ft of Head required to capture 100% of runoff

---

Commercial Lot 4

Design Q= 6.2 cfs  
CDOT Type C  
Area= 3.15 ft<sup>2</sup>  
Perimeter= 6 ft

Orifice Equation=> solve for H (Eq 2)  
h (ft)= 0.17

Weir Equation=> solve for H (Eq 4)  
h (ft)= 0.49

Larger h Controls: 0.49 ft of Head required to capture 100% of runoff

---

**PROJECT: CHAMBERS AND HESS FILING NO. 1**  
**SUBJECT: INLET DESIGNS**

**JOB #: D01173**  
**DATE: 10/22/2020**  
**BY: BHE**

Commercial Lot 5  
Design Q= 12.0 cfs  
CDOT Type C  
Area= 3.15 ft<sup>2</sup>  
Perimeter= 6 ft

Orifice Equation=> solve for H (Eq 2)  
h (ft)= 0.63

Weir Equation=> solve for H (Eq 4)  
h (ft)= 0.76

Larger h Controls: 0.76 ft of Head required to capture 100% of runoff

---

Commercial Lot 6  
Design Q= 5.5 cfs  
CDOT Type C  
Area= 3.15 ft<sup>2</sup>  
Perimeter= 6 ft

Orifice Equation=> solve for H (Eq 2)  
h (ft)= 0.13

Weir Equation=> solve for H (Eq 4)  
h (ft)= 0.45

Larger h Controls: 0.45 ft of Head required to capture 100% of runoff

---

Commercial Lot 7  
Design Q= 4.2 cfs  
CDOT Type C  
Area= 3.15 ft<sup>2</sup>  
Perimeter= 6 ft

Orifice Equation=> solve for H (Eq 2)  
h (ft)= 0.08

Weir Equation=> solve for H (Eq 4)  
h (ft)= 0.38

Larger h Controls: 0.38 ft of Head required to capture 100% of runoff

---

Commercial Lot 8  
Design Q= 5.0 cfs  
CDOT Type D  
Area= 6.30 ft<sup>2</sup>  
Perimeter= 9 ft

Orifice Equation=> solve for H (Eq 2)  
h (ft)= 0.03

Weir Equation=> solve for H (Eq 4)  
h (ft)= 0.33

Larger h Controls: 0.33 ft of Head required to capture 100% of runoff

---

**PROJECT: CHAMBERS AND HESS FILING NO. 1**  
**SUBJECT: INLET DESIGNS**

**JOB #: D01173**  
**DATE: 10/22/2020**  
**BY: BHE**

Commercial Lot 9

Design Q= 5.7 cfs

CDOT Type C

Area= 3.15 ft<sup>2</sup>

Perimeter= 6 ft

Orifice Equation=> solve for H (Eq 2)

h (ft)= 0.14

Weir Equation=> solve for H (Eq 4)

h (ft)= 0.46

Larger h Controls: 0.46 ft of Head required to capture 100% of runoff

---

Commercial Lot 10

Design Q= 11.1 cfs

CDOT Type D

Area= 6.30 ft<sup>2</sup>

Perimeter= 9 ft

Orifice Equation=> solve for H (Eq 2)

h (ft)= 0.13

Weir Equation=> solve for H (Eq 4)

h (ft)= 0.55

Larger h Controls: 0.55 ft of Head required to capture 100% of runoff

---

Commercial Lot 11

Design Q= 9.6 cfs

CDOT Type C

Area= 3.15 ft<sup>2</sup>

Perimeter= 6 ft

Orifice Equation=> solve for H (Eq 2)

h (ft)= 0.40

Weir Equation=> solve for H (Eq 4)

h (ft)= 0.66

Larger h Controls: 0.66 ft of Head required to capture 100% of runoff

---

Basin A14

Design Q= 1.8 cfs

CDOT Type D

Area= 6.30 ft<sup>2</sup>

Perimeter= 9 ft

Orifice Equation=> solve for H (Eq 2)

h (ft)= 0.00

Weir Equation=> solve for H (Eq 4)

h (ft)= 0.16

Larger h Controls: 0.16 ft of Head required to capture 100% of runoff

---

**ALLOWABLE CAPACITY FOR ONE-HALF OF STREET (Minor & Major Storm)**

(Based on Regulated Criteria for Maximum Allowable Flow Depth and Spread)

Project:  
Inlet ID:

**CHAMBERS AND HESS  
INLET 15 HESS ROAD**

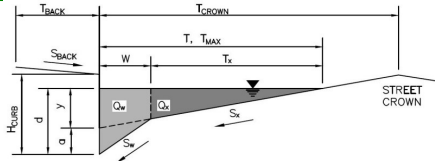

**Gutter Geometry (Enter data in the blue cells)**

Maximum Allowable Width for Spread Behind Curb  
 Side Slope Behind Curb (leave blank for no conveyance credit behind curb)  
 Manning's Roughness Behind Curb (typically between 0.012 and 0.020)  
 Height of Curb at Gutter Flow Line  
 Distance from Curb Face to Street Crown  
 Gutter Width  
 Street Transverse Slope  
 Gutter Cross Slope (typically 2 inches over 24 inches or 0.083 ft/ft)  
 Street Longitudinal Slope - Enter 0 for sump condition  
 Manning's Roughness for Street Section (typically between 0.012 and 0.020)

$T_{BACK} = 10.0$  ft  
 $S_{BACK} = 0.020$  ft/ft  
 $n_{BACK} = 0.020$   
 $H_{CURB} = 6.00$  inches  
 $T_{CROWN} = 62.0$  ft  
 $W = 2.00$  ft  
 $S_X = 0.021$  ft/ft  
 $S_W = 0.083$  ft/ft  
 $S_D = 0.030$  ft/ft  
 $n_{STREET} = 0.016$

Max. Allowable Spread for Minor & Major Storm  
 Max. Allowable Depth at Gutter Flowline for Minor & Major Storm  
 Allow Flow Depth at Street Crown (leave blank for no)

	Minor Storm	Major Storm	
$T_{MAX} =$	62.0	62.0	ft
$d_{MAX} =$	6.0	12.0	inches
	<input type="checkbox"/>	<input type="checkbox"/>	check = yes

**MINOR STORM Allowable Capacity is based on Depth Criterion**  
**MAJOR STORM Allowable Capacity is based on Depth Criterion**

	Minor Storm	Major Storm	
$Q_{allow} =$	17.2	141.3	cfs

**Minor storm max. allowable capacity GOOD - greater than the design flow given on sheet 'Inlet Management'**  
**Major storm max. allowable capacity GOOD - greater than the design flow given on sheet 'Inlet Management'**

## INLET ON A CONTINUOUS GRADE

Version 4.05 Released March 2017

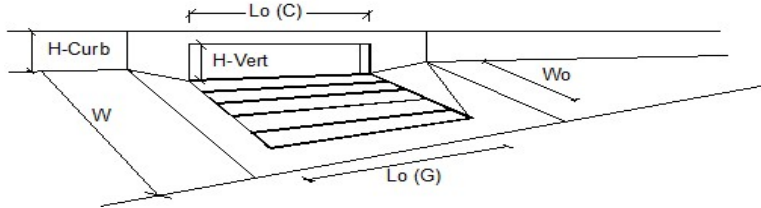

Design Information (Input)	MINOR	MAJOR	
Type of Inlet	CDOT Type R Curb Opening		
Local Depression (additional to continuous gutter depression 'a')	3.0	3.0	inches
Total Number of Units in the Inlet (Grate or Curb Opening)	2	2	
Length of a Single Unit Inlet (Grate or Curb Opening)	5.00	5.00	ft
Width of a Unit Grate (cannot be greater than W, Gutter Width)	N/A	N/A	ft
Clogging Factor for a Single Unit Grate (typical min. value = 0.5)	N/A	N/A	
Clogging Factor for a Single Unit Curb Opening (typical min. value = 0.1)	0.10	0.10	
<b>Street Hydraulics: OK - Q &lt; Allowable Street Capacity*</b>			
Design Discharge for Half of Street (from Sheet Inlet Management)	3.6	9.1	cfs
Water Spread Width	8.0	12.2	ft
Water Depth at Flowline (outside of local depression)	3.5	4.6	inches
Water Depth at Street Crown (or at T <sub>MAX</sub> )	0.0	0.0	inches
Ratio of Gutter Flow to Design Flow	0.680	0.478	
Discharge outside the Gutter Section W, carried in Section T <sub>x</sub>	1.2	4.8	cfs
Discharge within the Gutter Section W	2.4	4.3	cfs
Discharge Behind the Curb Face	0.0	0.0	cfs
Flow Area within the Gutter Section W	0.42	0.59	sq ft
Velocity within the Gutter Section W	5.9	7.3	fps
Water Depth for Design Condition	6.5	7.6	inches
<b>Grate Analysis (Calculated)</b>			
Total Length of Inlet Grate Opening	N/A	N/A	ft
Ratio of Grate Flow to Design Flow	N/A	N/A	
<b>Under No-Clogging Condition</b>			
Minimum Velocity Where Grate Splash-Over Begins	N/A	N/A	fps
Interception Rate of Frontal Flow	N/A	N/A	
Interception Rate of Side Flow	N/A	N/A	
Interception Capacity	N/A	N/A	cfs
<b>Under Clogging Condition</b>			
Clogging Coefficient for Multiple-unit Grate Inlet	N/A	N/A	
Clogging Factor for Multiple-unit Grate Inlet	N/A	N/A	
Effective (unclogged) Length of Multiple-unit Grate Inlet	N/A	N/A	ft
Minimum Velocity Where Grate Splash-Over Begins	N/A	N/A	fps
Interception Rate of Frontal Flow	N/A	N/A	
Interception Rate of Side Flow	N/A	N/A	
<b>Actual Interception Capacity</b>	N/A	N/A	cfs
<b>Carry-Over Flow = Q<sub>c</sub> - Q<sub>a</sub></b> (to be applied to curb opening or next d/s inlet)	N/A	N/A	cfs
<b>Curb or Slotted Inlet Opening Analysis (Calculated)</b>			
Equivalent Slope S <sub>e</sub> (based on grate carry-over)	0.148	0.110	ft/ft
Required Length L <sub>T</sub> to Have 100% Interception	9.61	17.66	ft
<b>Under No-Clogging Condition</b>			
Effective Length of Curb Opening or Slotted Inlet (minimum of L, L <sub>T</sub> )	9.61	10.00	ft
Interception Capacity	3.6	7.1	cfs
<b>Under Clogging Condition</b>			
Clogging Coefficient	1.25	1.25	
Clogging Factor for Multiple-unit Curb Opening or Slotted Inlet	0.06	0.06	
Effective (Unclogged) Length	9.37	9.37	ft
<b>Actual Interception Capacity</b>	3.6	6.9	cfs
<b>Carry-Over Flow = Q<sub>b</sub>(GRATE) - Q<sub>a</sub></b>	0.0	2.2	cfs
<b>Summary</b>			
Total Inlet Interception Capacity	3.6	6.9	cfs
Total Inlet Carry-Over Flow (flow bypassing inlet)	0.0	2.2	cfs
Capture Percentage = Q <sub>a</sub> /Q <sub>c</sub> =	100	76	%

P-7	161.00	36 inch	65.75	6,014.39	6,008.53
P-8	54.00	36 inch	47.96	6,008.92	6,006.13
P-11	84.00	36 inch	53.22	6,003.64	6,002.39
P-12	90.00	36 inch	53.13	6,001.66	5,999.07
P-13	28.00	36 inch	62.50	5,999.73	5,998.71
P-20	77.00	36 inch	88.60	6,048.89	6,035.91
P-21	102.00	36 inch	88.34	6,035.19	6,030.38
P-22	29.00	36 inch	87.89	6,031.03	6,028.72
P-23	184.00	18 inch	5.50	6,033.31	6,029.02
P-25	141.00	36 inch	53.37	6,006.83	6,004.38
P-26	22.00	18 inch	5.87	6,008.95	6,008.92
P-27	47.00	18 inch	5.91	6,010.48	6,009.07
P-28	94.00	18 inch	5.95	6,014.07	6,010.30
P-31	226.00	18 inch	3.80	6,025.90	6,021.91
P-32	212.00	18 inch	6.04	6,021.91	6,013.90
P-35	108.00	36 inch	67.21	5,999.04	5,994.01
P-36	119.00	36 inch	67.09	5,993.03	5,986.62

----- Elevations -----				
Label	Discharge	Ground	Upstream HGL	Downstream HGL
SDIN-1	88.60	6,062.42	6,048.89	6,048.89
SDMH-2	87.89	6,037.20	6,031.03	6,031.03
SDIN-3	66.84	6,036.51	6,029.02	6,029.02
SDMH-3	66.72	6,036.20	6,028.17	6,028.17
SDMH-4	66.05	6,030.00	6,019.72	6,018.84
SDMH-5	65.75	6,024.40	6,015.26	6,014.39
SDIN-4	47.96	6,017.37	6,008.92	6,008.92
SDIN-7	53.37	6,015.70	6,006.83	6,006.83
SDMH-9	53.22	6,012.30	6,004.38	6,003.64
SDMH-10	53.13	6,010.00	6,002.39	6,001.66
SDIN-8	62.50	6,008.42	5,999.73	5,999.73
SDIN-9	67.21	6,008.42	5,999.04	5,999.04
SDIN-2	5.50	6,041.41	6,033.31	6,033.31
SDMH-1	88.34	6,040.80	6,035.19	6,035.19
SDMH-8	5.87	6,018.30	6,009.07	6,008.95
SDMH-7	5.91	6,020.00	6,010.68	6,010.48
SDMH-6	5.95	6,023.40	6,014.27	6,014.07
SDIN-5	3.80	6,034.15	6,025.90	6,025.90
SDIN-6	6.04	6,030.16	6,021.91	6,021.91
Outlet	66.96	5,990.00	5,986.62	5,986.62

100 YEAR  
TAILWATER  
ELEVATION  
FOR UDSEWER

----- Elevations -----				
Label	Discharge	Ground	Upstream HGL	Downstream HGL
SDMH-11	67.09	6,006.00	5,994.01	5,993.03

Elapsed: 0 minute(s) 1 second(s)

<b>Program:</b> UDSEWER Math Model Interface 2.1.1.4 <b>Run Date:</b> 1/21/2021 4:40:13 PM	<h2 style="margin: 0;">UDSewer Results Summary</h2> <p><b>Project Title:</b> CHAMBERS AND HESS MAJOR STORM  <b>Project Description:</b> Default system</p>
---	--

## System Input Summary

### Rainfall Parameters

**Rainfall Return Period:** 100  
**Rainfall Calculation Method:** Formula

**One Hour Depth (in):**  
**Rainfall Constant "A":** 28.5  
**Rainfall Constant "B":** 10  
**Rainfall Constant "C":** 0.786

### Rational Method Constraints

**Minimum Urban Runoff Coeff.:** 0.20  
**Maximum Rural Overland Len. (ft):** 500  
**Maximum Urban Overland Len. (ft):** 300  
**Used UDFCD Tc. Maximum:** Yes

### Sizer Constraints

**Minimum Sewer Size (in):** 18.00  
**Maximum Depth to Rise Ratio:** 0.90  
**Maximum Flow Velocity (fps):** 20.0  
**Minimum Flow Velocity (fps):** 2.0

### Backwater Calculations:

**Tailwater Elevation (ft):** 6031.03 ←

## Manhole Input Summary:

		Given Flow		Sub Basin Information						
Element Name	Ground Elevation (ft)	Total Known Flow (cfs)	Local Contribution (cfs)	Drainage Area (Ac.)	Runoff Coefficient	5yr Coefficient	Overland Length (ft)	Overland Slope (%)	Gutter Length (ft)	Gutter Velocity (fps)
OUTFALL 1 S(99)	6038.00	0.00	0.00	0.00	0.00	0.00	0.00	0.00	0.00	0.00
EXISTING	6042.20	70.70	0.00	1.00	0.50	0.50	100.00	2.00	100.00	2.83

PARKER 234										
INL-01	6055.00	70.70	0.00	1.00	0.50	0.50	100.00	1.00	100.00	2.00
INL-02	6060.00	69.40	0.00	1.00	0.50	0.50	100.00	2.00	200.00	2.83
INL-04	6061.50	54.40	0.00	1.00	0.50	0.50	100.00	2.00	100.00	2.83
SDMH-01	6063.79	51.40	0.00	1.00	0.50	0.50	100.00	2.00	100.00	2.83
SDMH-02	6053.58	28.80	0.00	1.00	0.50	0.50	100.00	2.00	100.00	2.83
INL-11	6053.86	24.80	0.00	1.00	0.50	0.50	100.00	2.00	100.00	2.83
INL-12	6061.71	21.40	0.00	1.00	0.50	0.50	100.00	2.00	100.00	2.83
INL-13	6065.02	17.30	0.00	1.00	0.50	0.50	100.00	2.00	100.00	2.83
INL-14	6068.43	12.00	0.00	1.00	0.50	0.50	100.00	2.00	100.00	2.83
INL-16	6053.77	12.50	0.00	1.00	0.50	0.50	100.00	2.00	100.00	2.83
INL-05	6065.83	29.20	0.00	1.00	0.50	0.50	100.00	2.00	100.00	2.83
SDMH-03	6073.43	24.30	0.00	1.00	0.50	0.50	100.00	2.00	100.00	2.83
INL-07	6072.13	24.30	0.00	1.00	0.50	0.50	100.00	2.00	100.00	2.83
INL-08	6074.28	18.60	0.00	1.00	0.50	0.50	100.00	2.00	100.00	2.83
INL-09	6076.97	10.80	0.00	1.00	0.50	0.50	100.00	2.00	100.00	2.83
INL-10	6078.04	6.40	0.00	1.00	0.50	0.50	100.00	1.00	100.00	2.00
INL-03	6063.62	9.60	0.00	1.00	0.50	0.50	100.00	2.00	100.00	2.83

## Manhole Output Summary:

Element Name	Local Contribution					Total Design Flow				Comment
	Overland Time (min)	Gutter Time (min)	Basin Tc (min)	Intensity (in/hr)	Local Contrib (cfs)	Coeff. Area	Intensity (in/hr)	Manhole Tc (min)	Peak Flow (cfs)	
OUTFALL 1 S(99)	0.00	0.00	0.00	0.00	0.00	0.00	0.00	0.00	0.00	
EXISTING PARKER 234	8.62	0.59	9.21	NaN	NaN	9.00	7.86	NaN	70.70	
INL-01	10.83	0.83	11.11	NaN	NaN	8.50	8.32	NaN	70.70	Used UDFCD Tc Maximum
INL-02	8.62	1.18	9.80	NaN	NaN	8.00	8.68	NaN	69.40	
INL-04	8.62	0.59	9.21	NaN	NaN	7.00	7.77	NaN	54.40	
SDMH-01	8.62	0.59	9.21	NaN	NaN	6.50	7.91	NaN	51.40	
SDMH-02	8.62	0.59	9.21	NaN	NaN	3.00	9.60	NaN	28.80	
INL-11	8.62	0.59	9.21	NaN	NaN	2.00	12.40	NaN	24.80	
INL-12	8.62	0.59	9.21	NaN	NaN	1.50	14.27	NaN	21.40	
INL-13	8.62	0.59	9.21	NaN	NaN	1.00	17.30	NaN	17.30	
INL-14	8.62	0.59	9.21	NaN	NaN	0.50	24.00	NaN	12.00	
INL-16	8.62	0.59	9.21	NaN	NaN	0.50	25.00	NaN	12.50	
INL-05	8.62	0.59	9.21	NaN	NaN	3.00	9.73	NaN	29.20	
SDMH-03	8.62	0.59	9.21	NaN	NaN	2.50	9.72	NaN	24.30	
INL-07	8.62	0.59	9.21	NaN	NaN	2.00	12.15	NaN	24.30	
INL-08	8.62	0.59	9.21	NaN	NaN	1.50	12.40	NaN	18.60	
INL-09	8.62	0.59	9.21	NaN	NaN	1.00	10.80	NaN	10.80	

INL-10	10.83	0.83	11.11	NaN	NaN	0.50	12.80	NaN	6.40	Used UDFCD Tc Maximum
INL-03	8.62	0.59	9.21	NaN	NaN	0.50	19.20	NaN	9.60	

## Sewer Input Summary:

Element Name	Sewer Length (ft)	Elevation			Loss Coefficients			Given Dimensions		
		Downstream Invert (ft)	Slope (%)	Upstream Invert (ft)	Mannings n	Bend Loss	Lateral Loss	Cross Section	Rise (ft or in)	Span (ft or in)
EXISTING PARKER 234	104.00	6027.93	4.3	6032.40	0.013	0.09	0.00	CIRCULAR	36.00 in	36.00 in
INL-01	41.82	6034.06	4.6	6035.98	0.013	0.05	0.00	CIRCULAR	36.00 in	36.00 in
INL-02	33.00	6036.19	4.8	6037.77	0.013	0.05	0.00	CIRCULAR	36.00 in	36.00 in
INL-04	82.83	6041.80	2.8	6044.12	0.013	1.00	0.00	CIRCULAR	36.00 in	36.00 in
SDMH-01	194.39	6044.35	0.5	6045.32	0.013	0.05	0.00	CIRCULAR	36.00 in	36.00 in
SDMH-02	289.68	6045.84	0.5	6047.29	0.013	0.05	0.00	CIRCULAR	30.00 in	30.00 in
INL-11	5.77	6047.79	0.9	6047.84	0.013	0.81	0.00	CIRCULAR	24.00 in	24.00 in
INL-12	72.14	6048.03	4.9	6051.56	0.013	0.16	0.00	CIRCULAR	24.00 in	24.00 in
INL-13	111.22	6051.78	6.5	6059.01	0.013	0.05	0.00	CIRCULAR	18.00 in	18.00 in
INL-14	146.30	6059.49	3.0	6063.90	0.013	0.05	0.00	CIRCULAR	18.00 in	18.00 in
INL-16	18.67	6048.30	0.5	6048.39	0.013	1.00	0.00	CIRCULAR	18.00 in	18.00 in
INL-05	131.63	6046.32	7.5	6056.19	0.013	1.00	0.00	CIRCULAR	24.00 in	24.00 in
SDMH-03	213.67	6060.15	1.8	6064.00	0.013	0.05	0.00	CIRCULAR	24.00 in	24.00 in
INL-07	14.18	6064.21	3.7	6064.73	0.013	0.66	0.00	CIRCULAR	24.00 in	24.00 in
INL-08	125.44	6064.89	2.9	6068.53	0.013	0.05	0.00	CIRCULAR	24.00 in	24.00 in
INL-09	177.86	6069.08	1.4	6071.57	0.013	0.05	0.00	CIRCULAR	18.00 in	18.00 in
INL-10	102.16	6071.80	1.7	6073.54	0.013	0.05	0.00	CIRCULAR	18.00 in	18.00 in
INL-03	174.08	6043.33	9.0	6059.00	0.013	1.00	0.00	CIRCULAR	18.00 in	18.00 in

## Sewer Flow Summary:

Element Name	Full Flow Capacity		Critical Flow		Normal Flow				Flow Condition	Flow (cfs)	Surcharged Length (ft)	Comment
	Flow (cfs)	Velocity (fps)	Depth (in)	Velocity (fps)	Depth (in)	Velocity (fps)	Froude Number					
EXISTING PARKER 234	138.68	19.62	32.00	10.65	18.21	19.71	3.18	Supercritical Jump	70.70	3.21		
INL-01	143.30	20.27	32.00	10.65	17.86	20.20	3.30	Supercritical	70.70	0.00	Velocity is Too High	
INL-02	146.34	20.70	31.79	10.51	17.45	20.43	3.38	Pressurized	69.40	33.00	Velocity is Too High	
INL-04	111.93	15.84	28.73	8.99	17.70	15.72	2.58	Supercritical	54.40	0.00		
SDMH-01	47.24	6.68	36.00	7.27	36.00	7.27	0.00	Pressurized	51.40	194.39		
SDMH-02	29.10	5.93	21.96	7.48	24.31	6.76	0.81	Pressurized	28.80	289.68		
INL-11	21.07	6.71	24.00	7.89	24.00	7.89	0.00	Pressurized	24.80	5.77		
INL-12	50.18	15.97	19.86	7.70	10.95	15.34	3.23	Supercritical Jump	21.40	35.41		
INL-13	26.85	15.20	17.32	9.91	10.51	16.15	3.34	Supercritical Jump	17.30	0.25		
INL-14	18.29	10.35	15.77	7.31	10.64	11.04	2.27	Supercritical	12.00	0.00		
INL-16	7.33	4.15	18.00	7.07	18.00	7.07	0.00	Pressurized	12.50	18.67		
INL-05	62.11	19.77	22.20	9.62	11.58	19.47	3.96	Supercritical Jump	29.20	26.02		
SDMH-03	30.45	9.69	20.92	8.36	16.21	10.76	1.73	Supercritical	24.30	0.00		
INL-07	43.44	13.83	20.92	8.36	12.83	14.21	2.71	Supercritical Jump	24.30	12.03		
INL-08	38.64	12.30	18.63	7.11	11.74	12.18	2.46	Supercritical	18.60	0.00		
INL-09	12.46	7.05	15.12	6.81	12.94	7.94	1.39	Supercritical	10.80	0.00		
INL-10	13.75	7.78	11.74	5.24	8.63	7.64	1.80	Supercritical Jump	6.40	4.35		
INL-03	31.60	17.88	14.36	6.35	6.81	15.69	4.26	Supercritical	9.60	0.00		

- A Froude number of 0 indicates that pressured flow occurs (adverse slope or undersized pipe).
- If the sewer is not pressurized, full flow represents the maximum gravity flow in the sewer.
- If the sewer is pressurized, full flow represents the pressurized flow conditions.

## Sewer Sizing Summary:

Element Name	Peak Flow (cfs)	Cross Section	Existing		Calculated		Used			Comment
			Rise	Span	Rise	Span	Rise	Span	Area (ft <sup>2</sup> )	
EXISTING PARKER 234	70.70	CIRCULAR	36.00 in	36.00 in	30.00 in	30.00 in	36.00 in	36.00 in	7.07	
INL-01	70.70	CIRCULAR	36.00 in	36.00 in	30.00 in	30.00 in	36.00 in	36.00 in	7.07	
INL-02	69.40	CIRCULAR	36.00 in	36.00 in	30.00 in	30.00 in	36.00 in	36.00 in	7.07	

INL-04	54.40	CIRCULAR	36.00 in	36.00 in	30.00 in	30.00 in	36.00 in	36.00 in	7.07	
SDMH-01	51.40	CIRCULAR	36.00 in	36.00 in	42.00 in	42.00 in	36.00 in	36.00 in	7.07	Existing height is smaller than the suggested height. Existing width is smaller than the suggested width. Exceeds max. Depth/Rise
SDMH-02	28.80	CIRCULAR	30.00 in	30.00 in	30.00 in	30.00 in	30.00 in	30.00 in	4.91	
INL-11	24.80	CIRCULAR	24.00 in	24.00 in	27.00 in	27.00 in	24.00 in	24.00 in	3.14	Existing height is smaller than the suggested height. Existing width is smaller than the suggested width. Exceeds max. Depth/Rise
INL-12	21.40	CIRCULAR	24.00 in	24.00 in	18.00 in	18.00 in	24.00 in	24.00 in	3.14	
INL-13	17.30	CIRCULAR	18.00 in	18.00 in	18.00 in	18.00 in	18.00 in	18.00 in	1.77	
INL-14	12.00	CIRCULAR	18.00 in	18.00 in	18.00 in	18.00 in	18.00 in	18.00 in	1.77	
INL-16	12.50	CIRCULAR	18.00 in	18.00 in	24.00 in	24.00 in	18.00 in	18.00 in	1.77	Existing height is smaller than the suggested height. Existing width is smaller than the suggested width. Exceeds max. Depth/Rise
INL-05	29.20	CIRCULAR	24.00 in	24.00 in	21.00 in	21.00 in	24.00 in	24.00 in	3.14	
SDMH-03	24.30	CIRCULAR	24.00 in	24.00 in	24.00 in	24.00 in	24.00 in	24.00 in	3.14	
INL-07	24.30	CIRCULAR	24.00 in	24.00 in	21.00 in	21.00 in	24.00 in	24.00 in	3.14	
INL-08	18.60	CIRCULAR	24.00 in	24.00 in	21.00 in	21.00 in	24.00 in	24.00 in	3.14	
INL-09	10.80	CIRCULAR	18.00 in	18.00 in	18.00 in	18.00 in	18.00 in	18.00 in	1.77	
INL-10	6.40	CIRCULAR	18.00 in	18.00 in	18.00 in	18.00 in	18.00 in	18.00 in	1.77	
INL-03	9.60	CIRCULAR	18.00	18.00	18.00	18.00	18.00	18.00	1.77	

			in	in	in	in	in	in		
--	--	--	----	----	----	----	----	----	--	--

- Calculated diameter was determined by sewer hydraulic capacity rounded up to the nearest commercially available size.
- Sewer sizes should not decrease downstream.
- All hydraulics were calculated using the 'Used' parameters.

## Grade Line Summary:

Tailwater Elevation (ft): 6031.03

Element Name	Invert Elev.		Downstream Manhole Losses		HGL		EGL		
	Downstream (ft)	Upstream (ft)	Bend Loss (ft)	Lateral Loss (ft)	Downstream (ft)	Upstream (ft)	Downstream (ft)	Friction Loss (ft)	Upstream (ft)
EXISTING PARKER 234	6027.93	6032.40	0.00	0.00	6031.03	6035.07	6032.58	4.24	6036.83
INL-01	6034.06	6035.98	0.08	0.00	6035.55	6040.33	6041.89	0.00	6041.89
INL-02	6036.19	6037.77	0.07	0.00	6040.47	6040.82	6041.96	0.36	6042.32
INL-04	6041.80	6044.12	0.92	0.00	6043.27	6046.51	6047.11	0.66	6047.77
SDMH-01	6044.35	6045.32	0.04	0.00	6047.35	6048.50	6048.17	1.15	6049.32
SDMH-02	6045.84	6047.29	0.03	0.00	6048.81	6050.23	6049.35	1.42	6050.77
INL-11	6047.79	6047.84	0.78	0.00	6051.02	6051.09	6051.98	0.07	6052.05
INL-12	6048.03	6051.56	0.12	0.00	6051.45	6053.22	6052.17	1.97	6054.14
INL-13	6051.78	6059.01	0.07	0.00	6053.29	6060.45	6054.77	7.21	6061.98
INL-14	6059.49	6063.90	0.04	0.00	6060.49	6065.21	6062.27	3.78	6066.04
INL-16	6048.30	6048.39	0.78	0.00	6051.01	6051.27	6051.79	0.26	6052.05
INL-05	6046.32	6056.19	1.34	0.00	6049.84	6058.04	6051.18	8.30	6059.48
SDMH-03	6060.15	6064.00	0.05	0.00	6061.50	6065.74	6063.30	3.53	6066.83
INL-07	6064.21	6064.73	0.61	0.00	6066.51	6066.59	6067.44	0.14	6067.58
INL-08	6064.89	6068.53	0.03	0.00	6066.62	6070.08	6068.17	2.69	6070.87
INL-09	6069.08	6071.57	0.03	0.00	6070.16	6072.83	6071.14	2.41	6073.55
INL-10	6071.80	6073.54	0.01	0.00	6073.36	6074.52	6073.56	1.38	6074.95
INL-03	6043.33	6059.00	0.46	0.00	6043.90	6060.20	6047.72	13.11	6060.82

- Bend and Lateral losses only apply when there is an outgoing sewer. The system outfall, sewer #0, is not considered a sewer.
- Bend loss = Bend K \* V<sub>fi</sub><sup>2</sup> / (2 \* g)
- Lateral loss = V<sub>fo</sub><sup>2</sup> / (2 \* g) - Junction Loss K \* V<sub>fi</sub><sup>2</sup> / (2 \* g).
- Friction loss is always Upstream EGL - Downstream EGL.

## Excavation Estimate:

The trench side slope is 1.0 ft/ft

The minimum trench width is 2.00 ft

Element Name	Length (ft)	Wall (in)	Bedding (in)	Bottom Width (ft)	Downstream			Upstream			Volume (cu. yd)	Comment
					Top Width (ft)	Trench Depth (ft)	Cover (ft)	Top Width (ft)	Trench Depth (ft)	Cover (ft)		
EXISTING PARKER 234	104.00	4.00	6.00	6.67	18.14	10.91	6.74	17.60	10.63	6.47	397.53	
INL-01	41.82	4.00	6.00	6.67	14.28	8.97	4.81	36.04	19.85	15.69	327.10	
INL-02	33.00	4.00	6.00	6.67	35.62	19.64	15.48	42.46	23.06	18.90	497.80	
INL-04	82.83	4.00	6.00	6.67	34.40	19.03	14.87	32.76	18.21	14.05	936.93	
SDMH-01	194.39	4.00	6.00	6.67	32.30	17.98	13.82	34.94	19.30	15.14	2205.54	
SDMH-02	289.68	3.50	6.00	6.08	34.40	18.74	15.16	11.08	7.08	3.50	1951.58	
INL-11	5.77	3.00	4.00	5.50	10.58	6.37	3.54	11.04	6.60	3.77	9.14	
INL-12	72.14	3.00	4.00	5.50	10.66	6.41	3.58	19.30	10.73	7.90	198.49	
INL-13	111.22	2.50	4.00	4.92	19.36	10.47	8.22	11.52	6.55	4.30	302.25	
INL-14	146.30	2.50	4.00	4.92	10.56	6.07	3.82	8.56	5.07	2.82	178.99	
INL-16	18.67	2.50	4.00	4.92	10.06	5.82	3.57	10.26	5.92	3.67	24.72	
INL-05	131.63	3.00	4.00	5.50	33.94	18.05	15.22	18.28	10.22	7.39	971.54	
SDMH-03	213.67	3.00	4.00	5.50	10.36	6.26	3.43	17.86	10.01	7.18	528.71	
INL-07	14.18	3.00	4.00	5.50	17.44	9.80	6.97	13.80	7.98	5.15	39.57	
INL-08	125.44	3.00	4.00	5.50	13.48	7.82	4.99	10.50	6.33	3.50	232.36	
INL-09	177.86	2.50	4.00	4.92	9.90	5.74	3.49	10.30	5.94	3.69	233.50	
INL-10	102.16	2.50	4.00	4.92	9.84	5.71	3.46	8.50	5.04	2.79	117.56	
INL-03	174.08	2.50	4.00	4.92	32.84	17.21	14.96	8.74	5.16	2.91	994.78	

**Total earth volume for sewer trenches = 10148 cubic yards.**

- The trench was estimated to have a bottom width equal to the outer pipe diameter plus 36 inches.
- If the calculated width of the trench bottom is less than the minimum acceptable width, the minimum acceptable width was used.
- The sewer wall thickness is equal to: (equivalent diameter in inches/12)+1 inches
- The sewer bedding thickness is equal to:
  - Four inches for pipes less than 33 inches.
  - Six inches for pipes less than 60 inches.
  - Eight inches for all larger sizes.

# Channel Report

## MINOR STORM TAIL WATER CALCULATION FOR UD SEWER

### Circular

Diameter (ft) = 3.00

Invert Elev (ft) = 6027.92

Slope (%) = 4.30

N-Value = 0.013

### Calculations

Compute by: Known Q

Known Q (cfs) = 28.70

### Highlighted

Depth (ft) = 0.93

Q (cfs) = 28.70

Area (sqft) = 1.88

Velocity (ft/s) = 15.25

Wetted Perim (ft) = 3.55

Crit Depth, Yc (ft) = 1.74

Top Width (ft) = 2.78

EGL (ft) = 4.55

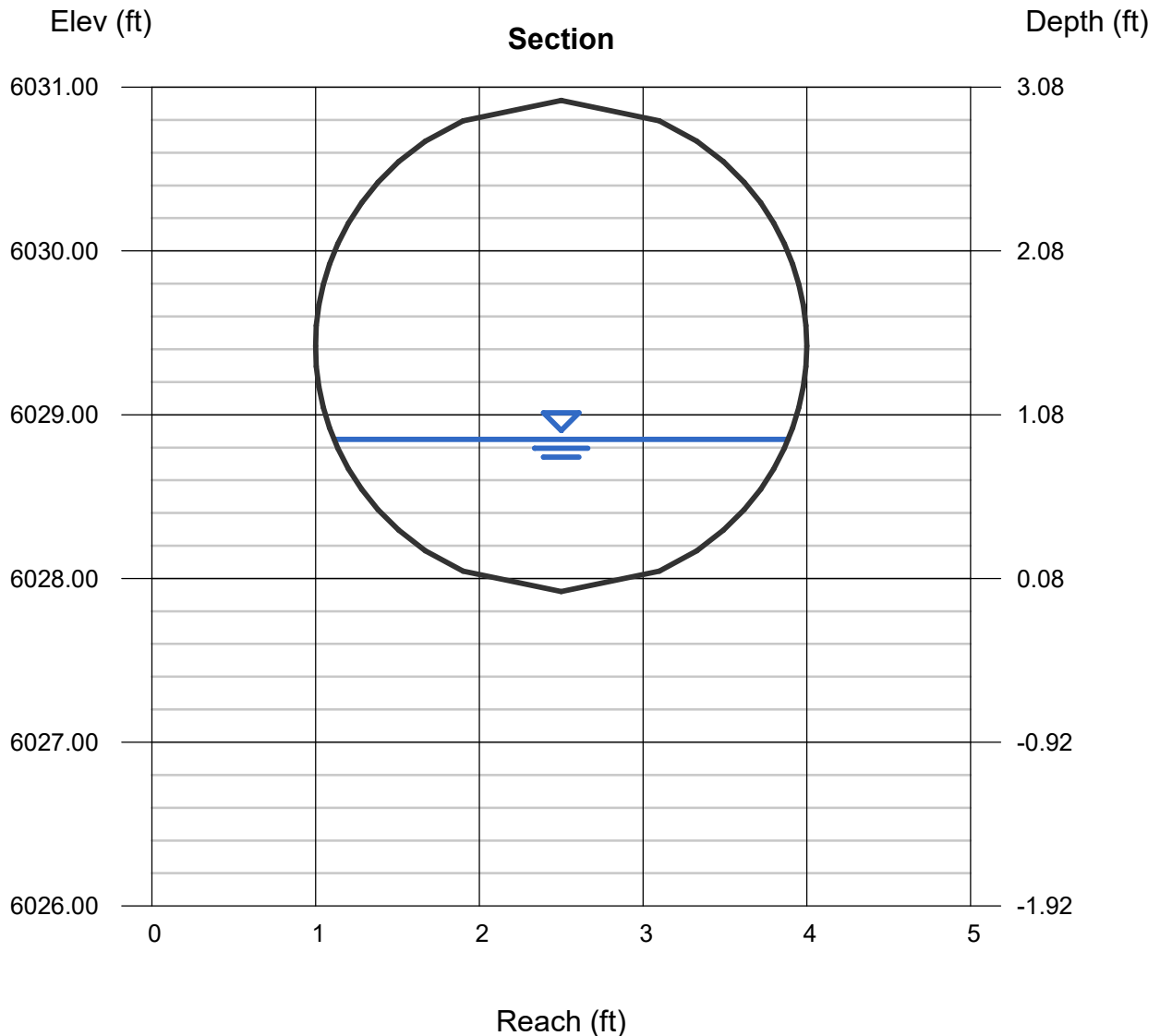

<b>Program:</b> UDSEWER Math Model Interface 2.1.1.4 <b>Run Date:</b> 1/21/2021 2:20:55 PM	<h2>UDSewer Results Summary</h2> <p><b>Project Title:</b> CHAMBERS AND HESS MINOR STORM  <b>Project Description:</b> Default system</p>
---	---

## System Input Summary

### Rainfall Parameters

**Rainfall Return Period:** 5  
**Rainfall Calculation Method:** Formula

**One Hour Depth (in):**  
**Rainfall Constant "A":** 28.5  
**Rainfall Constant "B":** 10  
**Rainfall Constant "C":** 0.786

### Rational Method Constraints

**Minimum Urban Runoff Coeff.:** 0.20  
**Maximum Rural Overland Len. (ft):** 500  
**Maximum Urban Overland Len. (ft):** 300  
**Used UDFCD Tc. Maximum:** Yes

### Sizer Constraints

**Minimum Sewer Size (in):** 18.00  
**Maximum Depth to Rise Ratio:** 0.90  
**Maximum Flow Velocity (fps):** 18.0  
**Minimum Flow Velocity (fps):** 2.0

### Backwater Calculations:

**Tailwater Elevation (ft):** 6028.85

## Manhole Input Summary:

		Given Flow		Sub Basin Information						
Element Name	Ground Elevation (ft)	Total Known Flow (cfs)	Local Contribution (cfs)	Drainage Area (Ac.)	Runoff Coefficient	5yr Coefficient	Overland Length (ft)	Overland Slope (%)	Gutter Length (ft)	Gutter Velocity (fps)
OUTFALL 1 S(99)	6038.00	0.00	0.00	0.00	0.00	0.00	0.00	0.00	0.00	0.00
EXISTING	6042.20	28.70	0.00	1.00	0.50	0.50	100.00	2.00	100.00	2.83

PARKER 234										
INL-01	6055.00	28.70	0.00	1.00	0.50	0.50	100.00	1.00	100.00	2.00
INL-02	6060.00	28.60	0.00	1.00	0.50	0.50	100.00	2.00	200.00	2.83
INL-04	6061.50	22.10	0.00	1.00	0.50	0.50	100.00	2.00	100.00	2.83
SDMH-01	6063.79	20.90	0.00	1.00	0.50	0.50	100.00	2.00	100.00	2.83
SDMH-02	6053.58	11.20	0.00	1.00	0.50	0.50	100.00	2.00	100.00	2.83
INL-11	6053.86	9.70	0.00	1.00	0.50	0.50	100.00	2.00	100.00	2.83
INL-12	6061.71	9.40	0.00	1.00	0.50	0.50	100.00	2.00	100.00	2.83
INL-13	6065.02	7.60	0.00	1.00	0.50	0.50	100.00	2.00	100.00	2.83
INL-14	6068.43	5.30	0.00	1.00	0.50	0.50	100.00	2.00	100.00	2.83
INL-16	6053.77	1.60	0.00	1.00	0.50	0.50	100.00	2.00	100.00	2.83
INL-05	6065.83	12.70	0.00	1.00	0.50	0.50	100.00	2.00	100.00	2.83
SDMH-03	6073.43	10.60	0.00	1.00	0.50	0.50	100.00	2.00	100.00	2.83
INL-07	6072.13	10.60	0.00	1.00	0.50	0.50	100.00	2.00	100.00	2.83
INL-08	6074.28	8.10	0.00	1.00	0.50	0.50	100.00	2.00	100.00	2.83
INL-09	6076.97	4.70	0.00	1.00	0.50	0.50	100.00	2.00	100.00	2.83
INL-10	6078.04	2.80	0.00	1.00	0.50	0.50	100.00	1.00	100.00	2.00
INL-03	6063.62	4.20	0.00	1.00	0.50	0.50	100.00	2.00	100.00	2.83

## Manhole Output Summary:

Element Name	Local Contribution					Total Design Flow				Comment
	Overland Time (min)	Gutter Time (min)	Basin Tc (min)	Intensity (in/hr)	Local Contrib (cfs)	Coeff. Area	Intensity (in/hr)	Manhole Tc (min)	Peak Flow (cfs)	
OUTFALL 1 S(99)	0.00	0.00	0.00	0.00	0.00	0.00	0.00	0.00	0.00	
EXISTING PARKER 234	8.62	0.59	9.21	NaN	NaN	9.00	3.19	NaN	28.70	
INL-01	10.83	0.83	11.11	NaN	NaN	8.50	3.38	NaN	28.70	Used UDFCD Tc Maximum
INL-02	8.62	1.18	9.80	NaN	NaN	8.00	3.58	NaN	28.60	
INL-04	8.62	0.59	9.21	NaN	NaN	7.00	3.16	NaN	22.10	
SDMH-01	8.62	0.59	9.21	NaN	NaN	6.50	3.22	NaN	20.90	
SDMH-02	8.62	0.59	9.21	NaN	NaN	3.00	3.73	NaN	11.20	
INL-11	8.62	0.59	9.21	NaN	NaN	2.00	4.85	NaN	9.70	
INL-12	8.62	0.59	9.21	NaN	NaN	1.50	6.27	NaN	9.40	
INL-13	8.62	0.59	9.21	NaN	NaN	1.00	7.60	NaN	7.60	
INL-14	8.62	0.59	9.21	NaN	NaN	0.50	10.60	NaN	5.30	
INL-16	8.62	0.59	9.21	NaN	NaN	0.50	3.20	NaN	1.60	
INL-05	8.62	0.59	9.21	NaN	NaN	3.00	4.23	NaN	12.70	
SDMH-03	8.62	0.59	9.21	NaN	NaN	2.50	4.24	NaN	10.60	
INL-07	8.62	0.59	9.21	NaN	NaN	2.00	5.30	NaN	10.60	
INL-08	8.62	0.59	9.21	NaN	NaN	1.50	5.40	NaN	8.10	
INL-09	8.62	0.59	9.21	NaN	NaN	1.00	4.70	NaN	4.70	

INL-10	10.83	0.83	11.11	NaN	NaN	0.50	5.60	NaN	2.80	Used UDFCD Tc Maximum
INL-03	8.62	0.59	9.21	NaN	NaN	0.50	8.40	NaN	4.20	

## Sewer Input Summary:

Element Name	Sewer Length (ft)	Elevation			Loss Coefficients			Given Dimensions		
		Downstream Invert (ft)	Slope (%)	Upstream Invert (ft)	Mannings n	Bend Loss	Lateral Loss	Cross Section	Rise (ft or in)	Span (ft or in)
EXISTING PARKER 234	104.00	6027.93	4.3	6032.40	0.013	0.09	0.00	CIRCULAR	36.00 in	36.00 in
INL-01	41.82	6034.06	4.6	6035.98	0.013	0.05	0.00	CIRCULAR	36.00 in	36.00 in
INL-02	33.00	6036.19	4.8	6037.77	0.013	0.05	0.00	CIRCULAR	36.00 in	36.00 in
INL-04	82.83	6041.80	2.8	6044.12	0.013	1.00	0.00	CIRCULAR	36.00 in	36.00 in
SDMH-01	194.39	6044.35	0.5	6045.32	0.013	0.05	0.00	CIRCULAR	36.00 in	36.00 in
SDMH-02	289.68	6045.84	0.5	6047.29	0.013	0.05	0.00	CIRCULAR	30.00 in	30.00 in
INL-11	5.77	6047.79	0.9	6047.84	0.013	0.81	0.00	CIRCULAR	24.00 in	24.00 in
INL-12	72.14	6048.03	4.9	6051.56	0.013	0.16	0.00	CIRCULAR	24.00 in	24.00 in
INL-13	111.22	6051.78	6.5	6059.01	0.013	0.05	0.00	CIRCULAR	24.00 in	24.00 in
INL-14	142.26	6059.49	3.1	6063.90	0.013	0.05	0.00	CIRCULAR	18.00 in	18.00 in
INL-16	18.67	6048.30	0.5	6048.39	0.013	1.00	0.00	CIRCULAR	18.00 in	18.00 in
INL-05	131.63	6046.32	7.5	6056.19	0.013	1.00	0.00	CIRCULAR	24.00 in	24.00 in
SDMH-03	213.67	6060.15	1.8	6064.00	0.013	0.05	0.00	CIRCULAR	24.00 in	24.00 in
INL-07	14.18	6064.21	3.7	6064.73	0.013	0.66	0.00	CIRCULAR	24.00 in	24.00 in
INL-08	125.44	6064.89	2.9	6068.53	0.013	0.05	0.00	CIRCULAR	24.00 in	24.00 in
INL-09	177.86	6069.08	1.4	6071.57	0.013	0.05	0.00	CIRCULAR	18.00 in	18.00 in
INL-10	102.16	6071.80	1.7	6073.54	0.013	0.05	0.00	CIRCULAR	18.00 in	18.00 in
INL-03	174.08	6043.33	9.0	6059.00	0.013	1.00	0.00	CIRCULAR	18.00 in	18.00 in

## Sewer Flow Summary:

Element Name	Full Flow Capacity		Critical Flow		Normal Flow				Flow (cfs)	Surcharged Length (ft)	Comment
	Flow (cfs)	Velocity (fps)	Depth (in)	Velocity (fps)	Depth (in)	Velocity (fps)	Froude Number	Flow Condition			
EXISTING PARKER 234	138.68	19.62	20.80	6.78	11.11	15.47	3.33	Supercritical	28.70	0.00	
INL-01	143.44	20.29	20.80	6.78	10.92	15.85	3.45	Supercritical	28.70	0.00	
INL-02	146.52	20.73	20.77	6.77	10.78	16.07	3.52	Supercritical	28.60	0.00	
INL-04	111.91	15.83	18.14	6.19	10.85	12.32	2.69	Supercritical	22.10	0.00	
SDMH-01	47.29	6.69	17.62	6.08	16.76	6.48	1.10	Supercritical	20.90	0.00	
SDMH-02	29.08	5.92	13.45	5.25	12.92	5.54	1.08	Supercritical	11.20	0.00	
INL-11	21.52	6.85	13.36	5.40	11.30	6.67	1.38	Supercritical	9.70	0.00	
INL-12	50.21	15.98	13.14	5.34	7.03	12.25	3.32	Supercritical	9.40	0.00	
INL-13	57.83	18.41	11.76	4.96	5.88	12.74	3.81	Supercritical	7.60	0.00	
INL-14	18.54	10.49	10.64	4.87	6.59	9.05	2.51	Supercritical	5.30	0.00	
INL-16	7.45	4.21	5.70	3.33	5.67	3.36	1.01	Supercritical	1.60	0.00	
INL-05	62.12	19.77	15.38	5.97	7.36	15.53	4.11	Supercritical	12.70	0.00	
SDMH-03	30.43	9.69	14.00	5.57	9.78	8.82	1.99	Supercritical	10.60	0.00	
INL-07	43.63	13.89	14.00	5.57	8.06	11.45	2.88	Supercritical	10.60	0.00	
INL-08	38.63	12.30	12.16	5.07	7.46	9.73	2.56	Supercritical	8.10	0.00	
INL-09	12.46	7.05	9.99	4.66	7.66	6.56	1.66	Supercritical	4.70	0.00	
INL-10	13.73	7.77	7.62	3.93	5.51	6.10	1.87	Supercritical	2.80	0.00	
INL-03	31.60	17.88	9.42	4.49	4.43	12.42	4.28	Supercritical	4.20	0.00	

- A Froude number of 0 indicates that pressured flow occurs (adverse slope or undersized pipe).
- If the sewer is not pressurized, full flow represents the maximum gravity flow in the sewer.
- If the sewer is pressurized, full flow represents the pressurized flow conditions.

## Sewer Sizing Summary:

Element Name	Peak Flow (cfs)	Cross Section	Existing		Calculated		Used			Comment
			Rise	Span	Rise	Span	Rise	Span	Area (ft <sup>2</sup> )	
EXISTING PARKER 234	28.70	CIRCULAR	36.00 in	36.00 in	21.00 in	21.00 in	36.00 in	36.00 in	7.07	
INL-01	28.70	CIRCULAR	36.00 in	36.00 in	21.00 in	21.00 in	36.00 in	36.00 in	7.07	
INL-02	28.60	CIRCULAR	36.00 in	36.00 in	21.00 in	21.00 in	36.00 in	36.00 in	7.07	
INL-04	22.10	CIRCULAR	36.00 in	36.00 in	21.00 in	21.00 in	36.00 in	36.00 in	7.07	
SDMH-01	20.90	CIRCULAR	36.00 in	36.00 in	27.00 in	27.00 in	36.00 in	36.00 in	7.07	
SDMH-02	11.20	CIRCULAR	30.00 in	30.00 in	24.00 in	24.00 in	30.00 in	30.00 in	4.91	
INL-11	9.70	CIRCULAR	24.00 in	24.00 in	18.00 in	18.00 in	24.00 in	24.00 in	3.14	
INL-12	9.40	CIRCULAR	24.00 in	24.00 in	18.00 in	18.00 in	24.00 in	24.00 in	3.14	
INL-13	7.60	CIRCULAR	24.00 in	24.00 in	18.00 in	18.00 in	24.00 in	24.00 in	3.14	
INL-14	5.30	CIRCULAR	18.00 in	18.00 in	18.00 in	18.00 in	18.00 in	18.00 in	1.77	

INL-16	1.60	CIRCULAR	18.00 in	18.00 in	18.00 in	18.00 in	18.00 in	18.00 in	18.00 in	1.77	
INL-05	12.70	CIRCULAR	24.00 in	24.00 in	18.00 in	18.00 in	24.00 in	24.00 in	24.00 in	3.14	
SDMH-03	10.60	CIRCULAR	24.00 in	24.00 in	18.00 in	18.00 in	24.00 in	24.00 in	24.00 in	3.14	
INL-07	10.60	CIRCULAR	24.00 in	24.00 in	18.00 in	18.00 in	24.00 in	24.00 in	24.00 in	3.14	
INL-08	8.10	CIRCULAR	24.00 in	24.00 in	18.00 in	18.00 in	24.00 in	24.00 in	24.00 in	3.14	
INL-09	4.70	CIRCULAR	18.00 in	18.00 in	18.00 in	18.00 in	18.00 in	18.00 in	18.00 in	1.77	
INL-10	2.80	CIRCULAR	18.00 in	18.00 in	18.00 in	18.00 in	18.00 in	18.00 in	18.00 in	1.77	
INL-03	4.20	CIRCULAR	18.00 in	18.00 in	18.00 in	18.00 in	18.00 in	18.00 in	18.00 in	1.77	

- Calculated diameter was determined by sewer hydraulic capacity rounded up to the nearest commercially available size.
- Sewer sizes should not decrease downstream.
- All hydraulics were calculated using the 'Used' parameters.

## Grade Line Summary:

Tailwater Elevation (ft): 6028.85

Element Name	Invert Elev.		Downstream Manhole Losses		HGL		EGL		
	Downstream (ft)	Upstream (ft)	Bend Loss (ft)	Lateral Loss (ft)	Downstream (ft)	Upstream (ft)	Downstream (ft)	Friction Loss (ft)	Upstream (ft)
EXISTING PARKER 234	6027.93	6032.40	0.00	0.00	6028.85	6034.13	6032.57	2.28	6034.85
INL-01	6034.06	6035.98	0.01	0.00	6034.97	6038.56	6038.87	0.00	6038.87
INL-02	6036.19	6037.77	0.01	0.00	6038.57	6040.84	6041.10	0.00	6041.10
INL-04	6041.80	6044.12	0.15	0.00	6042.70	6045.63	6045.06	1.17	6046.23
SDMH-01	6044.35	6045.32	0.01	0.00	6045.74	6046.79	6046.40	0.96	6047.36
SDMH-02	6045.84	6047.29	0.00	0.00	6046.92	6048.41	6047.39	1.44	6048.84
INL-11	6047.79	6047.84	0.12	0.00	6048.81	6048.95	6049.37	0.04	6049.41
INL-12	6048.03	6051.56	0.02	0.00	6048.98	6052.66	6050.94	2.16	6053.10
INL-13	6051.78	6059.01	0.00	0.00	6052.66	6059.99	6054.79	5.58	6060.37
INL-14	6059.49	6063.90	0.01	0.00	6060.04	6064.79	6061.31	3.84	6065.16
INL-16	6048.30	6048.39	0.01	0.00	6048.77	6048.87	6048.94	0.09	6049.04
INL-05	6046.32	6056.19	0.25	0.00	6047.04	6057.47	6050.68	7.35	6058.03
SDMH-03	6060.15	6064.00	0.01	0.00	6060.97	6065.17	6062.18	3.47	6065.65
INL-07	6064.21	6064.73	0.12	0.00	6065.28	6066.74	6066.91	0.00	6066.91
INL-08	6064.89	6068.53	0.01	0.00	6066.74	6069.54	6066.98	2.96	6069.94
INL-09	6069.08	6071.57	0.01	0.00	6069.72	6072.40	6070.39	2.35	6072.74
INL-10	6071.80	6073.54	0.00	0.00	6072.40	6074.18	6072.84	1.57	6074.42
INL-03	6043.33	6059.00	0.09	0.00	6043.70	6059.79	6046.10	14.00	6060.10

- Bend and Lateral losses only apply when there is an outgoing sewer. The system outfall, sewer #0, is not considered a sewer.
- Bend loss = Bend K \* V<sub>fi</sub><sup>2</sup> / (2 \* g)

- Lateral loss =  $V_{fo}^2 / (2 * g) - \text{Junction Loss } K * V_{fi}^2 / (2 * g)$ .
- Friction loss is always Upstream EGL - Downstream EGL.

## Excavation Estimate:

The trench side slope is 1.0 ft/ft

The minimum trench width is 2.00 ft

Element Name	Length (ft)	Wall (in)	Bedding (in)	Downstream				Upstream			Volume (cu. yd)	Comment
				Bottom Width (ft)	Top Width (ft)	Trench Depth (ft)	Cover (ft)	Top Width (ft)	Trench Depth (ft)	Cover (ft)		
EXISTING PARKER 234	104.00	4.00	6.00	6.67	18.14	10.91	6.74	17.60	10.63	6.47	397.53	
INL-01	41.82	4.00	6.00	6.67	14.29	8.98	4.81	36.04	19.85	15.69	327.14	
INL-02	33.00	4.00	6.00	6.67	35.63	19.65	15.48	42.46	23.06	18.90	497.88	
INL-04	82.83	4.00	6.00	6.67	34.40	19.03	14.87	32.76	18.21	14.05	936.88	
SDMH-01	194.39	4.00	6.00	6.67	32.30	17.99	13.82	34.94	19.30	15.14	2205.80	
SDMH-02	289.68	3.50	6.00	6.08	34.40	18.74	15.16	11.08	7.08	3.50	1951.25	
INL-11	5.77	3.00	4.00	5.50	10.58	6.38	3.54	11.04	6.60	3.77	9.14	
INL-12	72.14	3.00	4.00	5.50	10.67	6.42	3.58	19.30	10.73	7.90	198.55	
INL-13	111.22	3.00	4.00	5.50	18.86	10.51	7.68	11.02	6.59	3.76	301.35	
INL-14	142.26	2.50	4.00	4.92	10.56	6.07	3.82	8.56	5.07	2.82	174.06	
INL-16	18.67	2.50	4.00	4.92	10.07	5.83	3.58	10.26	5.92	3.67	24.73	
INL-05	131.63	3.00	4.00	5.50	33.94	18.06	15.22	18.28	10.22	7.39	971.72	
SDMH-03	213.67	3.00	4.00	5.50	10.35	6.26	3.43	17.86	10.01	7.18	528.55	
INL-07	14.18	3.00	4.00	5.50	17.45	9.81	6.97	13.80	7.98	5.15	39.59	
INL-08	125.44	3.00	4.00	5.50	13.48	7.82	4.99	10.50	6.33	3.50	232.30	
INL-09	177.86	2.50	4.00	4.92	9.90	5.74	3.49	10.30	5.94	3.69	233.51	
INL-10	102.16	2.50	4.00	4.92	9.83	5.71	3.46	8.50	5.04	2.79	117.50	
INL-03	174.08	2.50	4.00	4.92	32.83	17.21	14.96	8.74	5.16	2.91	994.49	

**Total earth volume for sewer trenches = 10142 cubic yards.**

- The trench was estimated to have a bottom width equal to the outer pipe diameter plus 36 inches.
- If the calculated width of the trench bottom is less than the minimum acceptable width, the minimum acceptable width was used.
- The sewer wall thickness is equal to:  $(\text{equivalent diameter in inches} / 12) + 1$  inches
- The sewer bedding thickness is equal to:
  - Four inches for pipes less than 33 inches.
  - Six inches for pipes less than 60 inches.
  - Eight inches for all larger sizes.

# Channel Report

## INLET 16 NORMAL DEPTH CALCULATION

### Circular

Diameter (ft) = 1.50

Invert Elev (ft) = 6046.78

Slope (%) = 2.41

N-Value = 0.013

### Calculations

Compute by: Known Q

Known Q (cfs) = 2.30

### Highlighted

Depth (ft) = 0.39

Q (cfs) = 2.300

Area (sqft) = 0.37

Velocity (ft/s) = 6.23

Wetted Perim (ft) = 1.61

Crit Depth,  $Y_c$  (ft) = 0.58

Top Width (ft) = 1.32

EGL (ft) = 0.99

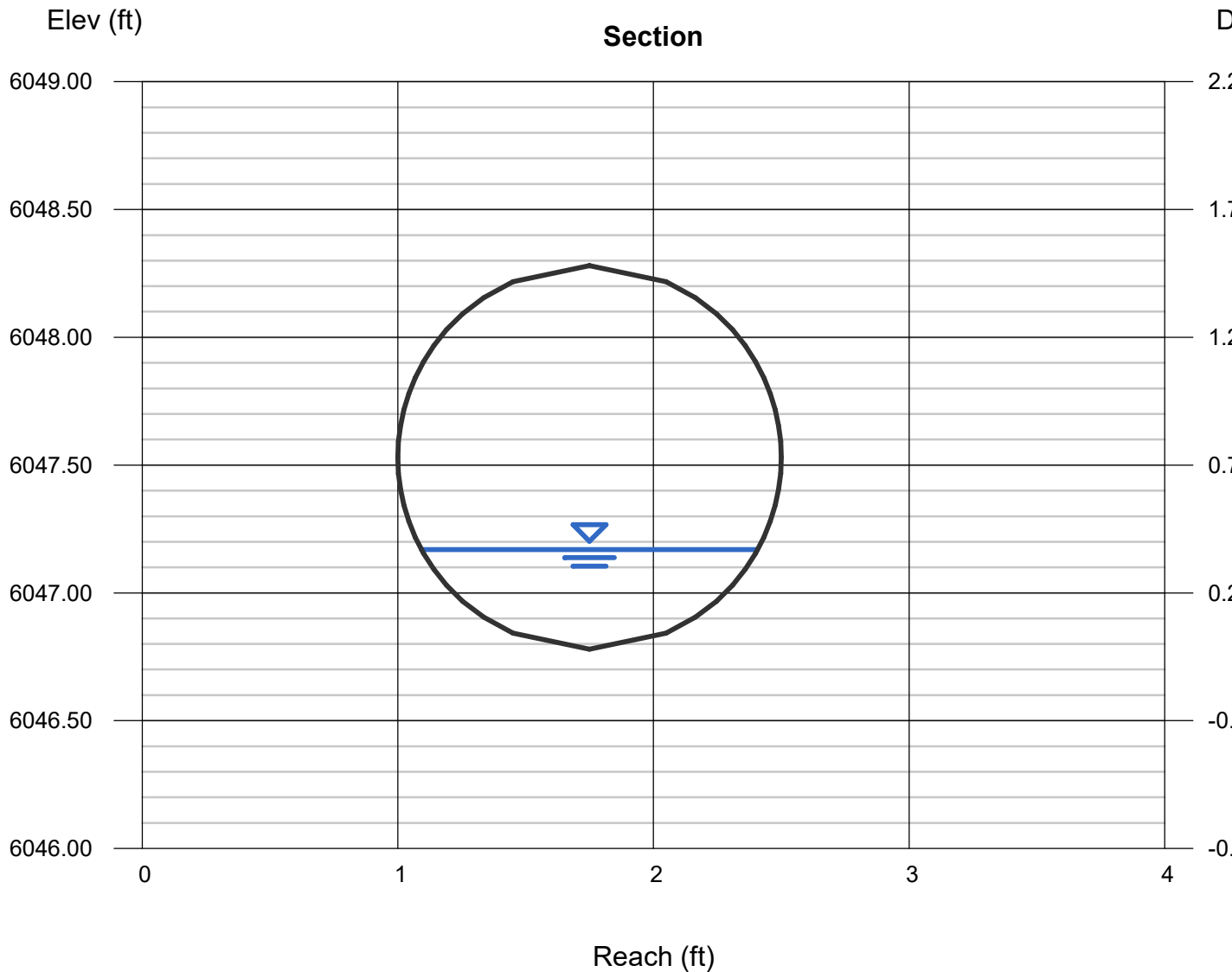

**Program:**  
UDSEWER Math  
Model Interface  
2.1.1.4  
**Run Date:**  
1/25/2021 11:55:56  
AM

## UDSewer Results Summary

**Project Title:** HESS ROAD STORM SEWER  
**Project Description:** Default system

## System Input Summary

### Rainfall Parameters

**Rainfall Return Period:** 5  
**Rainfall Calculation Method:** Formula

**One Hour Depth (in):**  
**Rainfall Constant "A":** 28.5  
**Rainfall Constant "B":** 10  
**Rainfall Constant "C":** 0.786

### Rational Method Constraints

**Minimum Urban Runoff Coeff.:** 0.20  
**Maximum Rural Overland Len. (ft):** 500  
**Maximum Urban Overland Len. (ft):** 300  
**Used UDFCD Tc. Maximum:** Yes

### Sizer Constraints

**Minimum Sewer Size (in):** 18.00  
**Maximum Depth to Rise Ratio:** 0.90  
**Maximum Flow Velocity (fps):** 18.0  
**Minimum Flow Velocity (fps):** 2.0

### Backwater Calculations:

**Tailwater Elevation (ft):** 6047.17

## Manhole Input Summary:

		Given Flow		Sub Basin Information						
Element Name	Ground Elevation (ft)	Total Known Flow (cfs)	Local Contribution (cfs)	Drainage Area (Ac.)	Runoff Coefficient	5yr Coefficient	Overland Length (ft)	Overland Slope (%)	Gutter Length (ft)	Gutter Velocity (fps)
OUTFALL 1	6050.83	0.00	0.00	0.00	0.00	0.00	0.00	0.00	0.00	0.00
INL-15	6055.82	3.60	0.00	1.00	0.50	0.50	100.00	2.00	100.00	2.83

## Manhole Output Summary:

Element Name	Local Contribution					Total Design Flow				Comment
	Overland Time (min)	Gutter Time (min)	Basin Tc (min)	Intensity (in/hr)	Local Contrib (cfs)	Coeff. Area	Intensity (in/hr)	Manhole Tc (min)	Peak Flow (cfs)	
OUTFALL 1	0.00	0.00	0.00	0.00	0.00	0.00	0.00	0.00	0.00	
INL-15	8.62	0.59	9.21	NaN	NaN	0.50	7.20	NaN	3.60	

## Sewer Input Summary:

Element Name	Sewer Length (ft)	Elevation			Loss Coefficients			Given Dimensions		
		Downstream Invert (ft)	Slope (%)	Upstream Invert (ft)	Mannings n	Bend Loss	Lateral Loss	Cross Section	Rise (ft or in)	Span (ft or in)
INL-15	135.37	6046.78	2.4	6050.04	0.013	0.03	0.00	CIRCULAR	18.00 in	18.00 in

## Sewer Flow Summary:

Element Name	Full Flow Capacity		Critical Flow		Normal Flow				Flow (cfs)	Surcharged Length (ft)	Comment
	Flow (cfs)	Velocity (fps)	Depth (in)	Velocity (fps)	Depth (in)	Velocity (fps)	Froude Number	Flow Condition			
INL-15	16.35	9.25	8.69	4.26	5.74	7.42	2.22	Supercritical	3.60	0.00	

- A Froude number of 0 indicates that pressured flow occurs (adverse slope or undersized pipe).
- If the sewer is not pressurized, full flow represents the maximum gravity flow in the sewer.
- If the sewer is pressurized, full flow represents the pressurized flow conditions.

## Sewer Sizing Summary:

Element Name	Peak Flow (cfs)	Cross Section	Existing		Calculated		Used			Comment
			Rise	Span	Rise	Span	Rise	Span	Area (ft <sup>2</sup> )	
INL-15	3.60	CIRCULAR	18.00 in	18.00 in	18.00 in	18.00 in	18.00 in	18.00 in	1.77	

- Calculated diameter was determined by sewer hydraulic capacity rounded up to the nearest commercially available size.
- Sewer sizes should not decrease downstream.
- All hydraulics were calculated using the 'Used' parameters.

## Grade Line Summary:

Tailwater Elevation (ft): 6047.17

Element Name	Invert Elev.		Downstream Manhole Losses		HGL		EGL		
	Downstream (ft)	Upstream (ft)	Bend Loss (ft)	Lateral Loss (ft)	Downstream (ft)	Upstream (ft)	Downstream (ft)	Friction Loss (ft)	Upstream (ft)
INL-15	6046.78	6050.04	0.00	0.00	6047.26	6050.76	6048.11	2.93	6051.05

- Bend and Lateral losses only apply when there is an outgoing sewer. The system outfall, sewer #0, is not considered a sewer.
- Bend loss = Bend K \* V<sub>fi</sub> ^ 2/(2\*g)
- Lateral loss = V<sub>fo</sub> ^ 2/(2\*g)- Junction Loss K \* V<sub>fi</sub> ^ 2/(2\*g).
- Friction loss is always Upstream EGL - Downstream EGL.

## Excavation Estimate:

The trench side slope is 1.0 ft/ft

The minimum trench width is 2.00 ft

Element Name	Length (ft)	Wall (in)	Bedding (in)	Bottom Width (ft)	Downstream			Upstream			Volume (cu. yd)	Comment
					Top Width (ft)	Trench Depth (ft)	Cover (ft)	Top Width (ft)	Trench Depth (ft)	Cover (ft)		
INL-15	135.37	2.50	4.00	4.92	7.60	4.59	2.34	11.06	6.32	4.07	162.68	

**Total earth volume for sewer trenches = 163 cubic yards.**

- The trench was estimated to have a bottom width equal to the outer pipe diameter plus 36 inches.
- If the calculated width of the trench bottom is less than the minimum acceptable width, the minimum acceptable width was used.
- The sewer wall thickness is equal to: (equivalent diameter in inches/12)+1 inches
- The sewer bedding thickness is equal to:
  - Four inches for pipes less than 33 inches.
  - Six inches for pipes less than 60 inches.
  - Eight inches for all larger sizes.

<b>Program:</b> UDSEWER Math Model Interface 2.1.1.4 <b>Run Date:</b> 10/26/2020 11:35:00 AM	<h2 style="text-align: center;">UDSewer Results Summary</h2> <p><b>Project Title:</b> HESS ROAD STORM SEWER MAJOR STORM  <b>Project Description:</b> Default system</p>
--	---

## System Input Summary

### Rainfall Parameters

**Rainfall Return Period:** 100  
**Rainfall Calculation Method:** Formula

**One Hour Depth (in):**  
**Rainfall Constant "A":** 28.5  
**Rainfall Constant "B":** 10  
**Rainfall Constant "C":** 0.786

### Rational Method Constraints

**Minimum Urban Runoff Coeff.:** 0.20  
**Maximum Rural Overland Len. (ft):** 500  
**Maximum Urban Overland Len. (ft):** 300  
**Used UDFCD Tc. Maximum:** Yes

### Sizer Constraints

**Minimum Sewer Size (in):** 18.00  
**Maximum Depth to Rise Ratio:** 0.90  
**Maximum Flow Velocity (fps):** 18.0  
**Minimum Flow Velocity (fps):** 2.0

### Backwater Calculations:

**Tailwater Elevation (ft):** 6048.28

## Manhole Input Summary:

		Given Flow		Sub Basin Information						
Element Name	Ground Elevation (ft)	Total Known Flow (cfs)	Local Contribution (cfs)	Drainage Area (Ac.)	Runoff Coefficient	5yr Coefficient	Overland Length (ft)	Overland Slope (%)	Gutter Length (ft)	Gutter Velocity (fps)
OUTFALL 1	6050.83	0.00	0.00	0.00	0.00	0.00	0.00	0.00	0.00	0.00
INL-15	6055.82	6.90	0.00	1.00	0.50	0.50	100.00	2.00	100.00	2.83

## Manhole Output Summary:

Element Name	Local Contribution					Total Design Flow				Comment
	Overland Time (min)	Gutter Time (min)	Basin Tc (min)	Intensity (in/hr)	Local Contrib (cfs)	Coeff. Area	Intensity (in/hr)	Manhole Tc (min)	Peak Flow (cfs)	
OUTFALL 1	0.00	0.00	0.00	0.00	0.00	0.00	0.00	0.00	0.00	
INL-15	8.62	0.59	9.21	NaN	NaN	0.50	13.80	NaN	6.90	

## Sewer Input Summary:

Element Name	Sewer Length (ft)	Elevation			Loss Coefficients			Given Dimensions		
		Downstream Invert (ft)	Slope (%)	Upstream Invert (ft)	Mannings n	Bend Loss	Lateral Loss	Cross Section	Rise (ft or in)	Span (ft or in)
INL-15	135.37	6046.79	2.4	6050.04	0.013	0.03	0.00	CIRCULAR	18.00 in	18.00 in

## Sewer Flow Summary:

Element Name	Full Flow Capacity		Critical Flow		Normal Flow				Flow (cfs)	Surcharged Length (ft)	Comment
	Flow (cfs)	Velocity (fps)	Depth (in)	Velocity (fps)	Depth (in)	Velocity (fps)	Froude Number	Flow Condition			
INL-15	16.32	9.23	12.20	5.41	8.17	8.85	2.16	Supercritical	6.90	0.00	

- A Froude number of 0 indicates that pressured flow occurs (adverse slope or undersized pipe).
- If the sewer is not pressurized, full flow represents the maximum gravity flow in the sewer.
- If the sewer is pressurized, full flow represents the pressurized flow conditions.

## Sewer Sizing Summary:

Element Name	Peak Flow (cfs)	Cross Section	Existing		Calculated		Used			Comment
			Rise	Span	Rise	Span	Rise	Span	Area (ft <sup>2</sup> )	
INL-15	6.90	CIRCULAR	18.00 in	18.00 in	18.00 in	18.00 in	18.00 in	18.00 in	1.77	

- Calculated diameter was determined by sewer hydraulic capacity rounded up to the nearest commercially available size.
- Sewer sizes should not decrease downstream.
- All hydraulics were calculated using the 'Used' parameters.

## Grade Line Summary:

Tailwater Elevation (ft): 6048.28

Element Name	Invert Elev.		Downstream Manhole Losses		HGL		EGL		
	Downstream (ft)	Upstream (ft)	Bend Loss (ft)	Lateral Loss (ft)	Downstream (ft)	Upstream (ft)	Downstream (ft)	Friction Loss (ft)	Upstream (ft)
INL-15	6046.79	6050.04	0.00	0.00	6048.28	6051.06	6048.69	2.82	6051.51

- Bend and Lateral losses only apply when there is an outgoing sewer. The system outfall, sewer #0, is not considered a sewer.
- Bend loss = Bend K \* V<sub>fi</sub> ^ 2/(2\*g)
- Lateral loss = V<sub>fo</sub> ^ 2/(2\*g)- Junction Loss K \* V<sub>fi</sub> ^ 2/(2\*g).
- Friction loss is always Upstream EGL - Downstream EGL.

## Excavation Estimate:

The trench side slope is 1.0 ft/ft

The minimum trench width is 2.00 ft

Element Name	Length (ft)	Wall (in)	Bedding (in)	Bottom Width (ft)	Downstream			Upstream			Volume (cu. yd)	Comment
					Top Width (ft)	Trench Depth (ft)	Cover (ft)	Top Width (ft)	Trench Depth (ft)	Cover (ft)		
INL-15	135.37	2.50	4.00	4.92	7.58	4.58	2.33	11.06	6.32	4.07	162.46	

**Total earth volume for sewer trenches = 162 cubic yards.**

- The trench was estimated to have a bottom width equal to the outer pipe diameter plus 36 inches.
- If the calculated width of the trench bottom is less than the minimum acceptable width, the minimum acceptable width was used.
- The sewer wall thickness is equal to: (equivalent diameter in inches/12)+1 inches
- The sewer bedding thickness is equal to:
  - Four inches for pipes less than 33 inches.
  - Six inches for pipes less than 60 inches.
  - Eight inches for all larger sizes.

## **Appendix C**

### **Excerpts from Final Drainage Report for the Parker 234 Subdivision For Detention Pond “A”**

The developed site can be divided into four (4) major basins, being Basins A, B, C and D. Each of these major basins contains a proposed water quality/ detention pond area.

### **Basin A**

Basin A is comprised of most of the eastern portion of the project, including the proposed commercial site, and contributes runoff to Pond A. This facility is located in the northeasterly corner of the site, adjacent to and immediately west of the southerly extension of Jordan Rd. Pond A will discharge easterly, under Jordan Road, to the existing drainageway to Cherry Creek. Basin A is subdivided into thirteen sub-basins, and generally corresponds to historic basins C-3, C-4, C-5 and a portion of historic basin C-2. Runoff within Basin A flows overland to the internal storm drainage system, and ultimately in Pond A.

The proposed detention pond for Basin A serves only the residential portion. At such time that the commercial lot is developed, a separate detention and water quality facility will need to be provided to service that area.

Pond A is located in Tract B. Storm water will be directed to this pond via overland flow and Storm Drain Line B. The pond is sized to hold the required volume for 100-year detention and water quality per the Town of Parker and UDFCD requirements. This needed 100 year volume is 2.72. The water quality volume required is 0.68 Ac.ft. The total volume, including 100-year detention and WQCV, is accumulated by elevation 5992.1. The weir structure will have a top elevation at 5995.0 and a bottom equal to the 100-year water surface elevation, 5992.1. A 1.42' diameter orifice plate will be installed on the outlet pipe to control to pond's allowable release rate, 36.39 cfs. An outlet pipe is sized to convey 100% of the tributary developed 100-year flow,  $Q_{100yr.} = 191.70$  cfs. Storm events that exceed the volume provided in Pond A will be routed through the pond by the emergency overflow spillway. Both pond exits, the spillway and the storm drain, will be protected by riprap.

During initial and interim construction phases, Pond A will have a temporary riser pipe, rather than the permanent outlet structure to allow it to function as a sediment control pond. Also, the spillway will not be cut out of the earth berm that surrounds the pond, so that the pond can have additional volume, which may be needed during the construction operations that typically produce additional sediment. During the final stages of construction, the pond will be modified to include the earth-weir. The perforated outlet pipe will be replaced by the concrete outlet structure.

### **Basin B**

Basin B includes the north-central portion of the project, and directs runoff to detention Pond B. This facility is located adjacent to and immediately southwesterly of the proposed alignment of Chambers Road. Discharge of the computed release rate from Pond B will travel under Chambers Road via a 42" RCP (Storm Line U), into the existing natural drainage-way at that location. The Antelope Heights project, immediately downstream from this discharge point, is coordinating engineering design to accommodate this historic runoff rate. Eventually, this pipe will be connected to the



Telephone Log  
 Meeting Record  
 Calculations  
 Other

- Divide Basin A
- into Commercial
- & Residential

Commercial Property

developed

12.56 Ac. 95% impervious

$$\rightarrow \text{detention vol.}_{100} = 1.852 \text{ Ac. ft.}$$

$$\text{WQ CV} = \frac{0.562 \text{ Ac. ft.}}{2.414 \text{ Ac. ft.}}$$

Residential Property

30.25 Ac. 56% impervious

$$\rightarrow \text{detention vol.}_{100} = 2.718 \text{ Ac. ft.}$$

$$\text{WQ CV} = \frac{0.676 \text{ Ac. ft.}}{3.394 \text{ Ac. ft.}}$$

$$= 147,843 \text{ ft}^3$$



CONSULTANTS, INC.  
 CIVIL ENGINEERING  
 LAND SURVEYING  
 LAND PLANNING

Project Name/Number Parkway 234 / 01804102  
 Date: 2-3-03  
 Sheet 2 of 5

Telephone Log  
 Meeting Record  
 Calculations  
 Other

<u>POND A</u>									
Area = 30.25 Ac.									
# of homes = 130 avg. sq. footage = 1660 ft <sup>2</sup> , 2 story									
Area (park) = 1.71 Ac.									
Area (lots) = 15.46 Ac.									
Area (roads) = 11.19 Ac.									
Area (open space) = 4.05 Ac.									
$130 / 15.46 = 8.41$ dwellings / Ac. $\rightarrow$ 36% impervious per R0-5									
$\frac{1.71(5\%) + 15.46(36\%) + 11.19(100\%) + 4.05(0\%)}{30.25 \text{ Ac.}} = 56\%$									

Detention (V=KA)

## DETENTION REQUIREMENTS - ONSITE BASINS

Subdivision: Parker 234  
 Location: Parker

Project Name: Parker 234  
 Project No. 1804102  
 By: MEF  
 Checked By: KAL  
 Date: 01/24/03

SOIL GROUPS B/C

Q10R= 0.23  
 Q100R= 0.85

Note: Allowable release rates for type C soil groups is greater than type B soils, however, rates for type B soil was used for conservatism.

BASIN/LAND USE	DRAINAGE AREA (AC.)	% IMPERV.	V <sub>10</sub> (AC. FT.)	V <sub>100</sub> (AC. FT.)	Q <sub>10R</sub> (CFS)	Q <sub>100R</sub> (CFS)
Basin A	30.25	56	1.552	2.718	6.96	25.71
Basin B	59.88	54	2.958	5.193	13.77	50.90
Basin C	8.50	25	0.186	0.337	1.96	7.23
Basin D	34.41	26	0.785	1.423	7.91	29.25
Commerical Property	12.6	95	1.110	1.852	2.89	10.68
SUM			6.590	11.524	33.5	123.8

**DETENTION PONDING FORMULAS:**

$$V_{100} = K_{100} \times A$$

$$V_{10} = K_{10} \times A$$

$$K_{100} = (1.78I - 0.002I^2 - 3.56) / 1000$$

$$K_{10} = (0.95I - 1.90) / 1000$$

$$Q_{100R} = Q_{100R} \times A$$

$$Q_{10R} = Q_{10R} \times A$$

**Design Procedure Form: Extended Detention Basin (EDB) - Sedimentation Facility**

Sheet 1 of 3

**Designer:** MEF  
**Company:** CVL Consultants  
**Date:** January 31, 2003  
**Project:** Parker 234  
**Location:** Pond A

<p><b>1. Basin Storage Volume</b></p> <p>A) Tributary Area's Imperviousness Ratio (<math>i = I_a / 100</math>)</p> <p>B) Contributing Watershed Area (Area)</p> <p>C) Water Quality Capture Volume (WQCV) (<math>WQCV = 1.0 * (0.91 * I^3 - 1.19 * I^2 + 0.78 * I)</math>)</p> <p>D) Design Volume: <math>Vol = (WQCV / 12) * Area * 1.2</math></p>	<p><math>I_a =</math> <u>56.00</u> %  <math>i =</math> <u>0.56</u></p> <p>Area = <u>30.25</u> acres</p> <p>WQCV = <u>0.22</u> watershed inches</p> <p>Vol = <u>0.676</u> acre-feet</p>
<p><b>2. Outlet Works</b></p> <p>A) Outlet Type (Check One)</p> <p>B) Depth at Outlet Above Lowest Perforation (H)</p> <p>C) Required Maximum Outlet Area per Row, (<math>A_o</math>)</p> <p>D) Perforation Dimensions (enter one only):                      i) Circular Perforation Diameter <b>OR</b>                      ii) 2" Height Rectangular Perforation Width</p> <p>E) Number of Columns (nc, See Table 6a-1 For Maximum)</p> <p>F) Actual Design Outlet Area per Row (<math>A_o</math>)</p> <p>G) Number of Rows (nr)</p> <p>H) Total Outlet Area (<math>A_{ot}</math>)</p>	<p><input checked="" type="checkbox"/> Orifice Plate  <input type="checkbox"/> Perforated Riser Pipe  <input type="checkbox"/> Other: _____</p> <hr/> <p>H = <u>4.27</u> feet</p> <p><math>A_o =</math> <u>0.52</u> square inches</p> <p>D = <u>0.813</u> inches, <b>OR</b>                      W = _____ inches</p> <p>nc = <u>1</u> number</p> <p><math>A_o =</math> <u>0.52</u> square inches</p> <p>nr = <u>13</u> number</p> <p><math>A_{ot} =</math> <u>6.65</u> square inches</p>
<p><b>3. Trash Rack</b></p> <p>A) Needed Open Area: <math>A_r = 0.5 * (\text{Figure 7 Value}) * A_{ot}</math></p> <p>B) Type of Outlet Opening (Check One)</p> <p>C) For 2", or Smaller, <b>Round Opening</b> (Ref.: Figure 6a):</p> <p>i) Width of Trash Rack and Concrete Opening (<math>W_{conc}</math>) from Table 6a-1</p> <p>ii) Height of Trash Rack Screen (<math>H_{TR}</math>)</p>	<p><math>A_r =</math> <u>231</u> square inches</p> <p><input checked="" type="checkbox"/> <math>\leq 2"</math> Diameter <b>Round</b>  <input type="checkbox"/> 2" High <b>Rectangular</b>  <input type="checkbox"/> Other: _____</p> <hr/> <p><math>W_{conc} =</math> <u>6</u> inches</p> <p><math>H_{TR} =</math> <u>81</u> inches</p>

**Design Procedure Form: Extended Detention Basin (EDB) - Sedimentation Facility**

Sheet 2 of 3

**Designer:** MEF  
**Company:** CVL Consultants  
**Date:** January 31, 2003  
**Project:** Parker 234  
**Location:** Pond A

<p>iii) Type of Screen (Based on Depth H), Describe if "Other"</p> <p>iv) Screen Opening Slot Dimension, Describe if "Other"</p> <p>v) Spacing of Support Rod (O.C.) Type and Size of Support Rod (Ref.: Table 6a-2)</p> <p>vi) Type and Size of Holding Frame (Ref.: Table 6a-2)</p> <p>D) For 2' High <b>Rectangular Opening</b> (Refer to Figure 6b):</p> <p>i) Width of Rectangular Opening (W)</p> <p>ii) Width of Perforated Plate Opening (<math>W_{conc} = W + 12"</math>)</p> <p>iii) Width of Trashrack Opening (<math>W_{opening}</math>) from Table 6b-1</p> <p>iv) Height of Trash Rack Screen (<math>H_{TR}</math>)</p> <p>v) Type of Screen (based on depth H) (Describe if "Other")</p> <p>vi) Cross-bar Spacing (Based on Table 6b-1, Klemp<sup>TM</sup> KPP Grating). Describe if "Other"</p> <p>vii) Minimum Bearing Bar Size (Klemp<sup>TM</sup> Series, Table 6b-2) (Based on depth of WQCV surcharge)</p>	<p><u>  x  </u> S.S. #93 VEE Wire (US Filter) Other: _____</p> <hr/> <p><u>  X  </u> 0.139" (US Filter) Other: _____</p> <hr/> <p><u>  0.75  </u> inches <b>#156 VEE</b></p> <hr/> <p><b>3/8 in. x 1.0 in. flat bar</b></p> <hr/> <p>W = <u>          </u> inches  <math>W_{conc} =</math> <u>          </u> inches  <math>W_{opening} =</math> <u>          </u> inches  <math>H_{TR} =</math> <u>          </u> inches</p> <p><u>          </u> Klemp<sup>TM</sup> KPP Series Aluminum Other: _____</p> <hr/> <p><u>          </u> inches Other: _____</p> <hr/>
<p>4. Detention Basin length to width ratio</p>	<p><u>  1.00  </u> (L/W)</p>
<p>5 Pre-sedimentation Forebay Basin - Enter design values</p> <p>A) Volume (no less than 5% of Design Volume from 1D)</p> <p>B) Surface Area</p> <p>C) Connector Pipe Diameter (Size to drain this volume in 5-minutes under inlet control)</p> <p>D) Paved/Hard Bottom and Sides</p>	<p><u>  0.062  </u> acre-feet</p> <p><u>  0.067  </u> acres</p> <p><u>  6  </u> inches</p> <p><u>  y  </u> yes/no</p>

**Design Procedure Form: Extended Detention Basin (EDB) - Sedimentation Facility**

**Designer:** MEF  
**Company:** CVL Consultants  
**Date:** January 31, 2003  
**Project:** Parker 234  
**Location:** Pond A

<p>6. Two-Stage Design - See Figure EDB-1</p> <p>A) Top Stage (Depth <math>D_{WQ} = 2'</math> Minimum)</p> <p>B) Bottom Stage Depth (<math>D_{BS} = 1.0'</math> Minimum, <math>2.0'</math> Maximum)                  Bottom Stage Storage (no less than 3% of Design Volume (0.02027596032 acre-feet.))</p> <p>C) Micro Pool (Minimum Depth = the Larger of                  0.5 * Top Stage Depth (1.3') or 2.5')</p> <p>D) Total Volume: <math>Vol_{tot} = \text{Storage from 5A} + 6A + 6B</math>                  (Must be &gt; Design Volume in 1D, or 0.675865344 acre-feet.)</p>	<p><math>D_{WQ} = \underline{2.60}</math> feet                  Storage = <math>\underline{0.645}</math> acre-feet</p> <p><math>D_{BS} = \underline{1.50}</math> feet                  Storage = <math>\underline{0.031}</math> acre-feet                  Surf. Area = <math>\underline{0.021}</math> acres</p> <p>Depth = <math>\underline{2.50}</math> feet                  Storage = <math>\underline{0.024}</math> acre-feet                  Surf. Area = <math>\underline{0.010}</math> acres</p> <p><math>Vol_{tot} = \underline{0.738}</math> acre-feet</p>
<p>7. Basin Side Slopes (Z, horizontal distance per unit vertical)                  Minimum Z = 4, Flatter Preferred</p>	<p>Z = <math>\underline{4.00}</math> (horizontal/vertical)</p>
<p>8. Dam Embankment Side Slopes (Z, horizontal distance)                  per unit vertical) Minimum Z = 3, Flatter Preferred</p>	<p>Z = <math>\underline{4.00}</math> (horizontal/vertical)</p>
<p>9. Vegetation (Check the method or describe "Other")</p>	<p><input checked="" type="checkbox"/> Native Grass  <input type="checkbox"/> Irrigated Turf Grass  <input type="checkbox"/> Other: _____</p>

Notes: \_\_\_\_\_  
 \_\_\_\_\_  
 \_\_\_\_\_  
 \_\_\_\_\_  
 \_\_\_\_\_

## Pond Volume (FAA Method)

Subdivision Parker 234  
 Location Parker

Project Name: Parker 234  
 Project No. 1804102

By: MEF

Checked By: KAL

Date: 1/31/03

Volume= $\frac{1}{3} \times \text{Depth} \times (A+B+(A*B)^{0.5})$

A - Upper Surface

B - Lower Surface

### Pond A

Elevation	Surface Area (square feet)	$A+B+(A*B)^{0.5}$	1/3	Depth (feet)	Volume (cubic feet)	Cumulative Volume (cubic feet)
5982.00	0	0.0	0.0	0.00	0	0
5983.00	301	301.0	100.3	1.00	100	100
5984.00	751	1527.4	509.1	1.00	509	609
5984.50	984	2594.6	864.9	0.50	432	1,042
5985.00	1,332	3083.2	1027.7	0.50	514	1,556
5986.00	2,485	2485.0	828.3	1.00	828	2,384
5987.00	6,297	12737.8	4245.9	1.00	4,246	6,630
5988.00	16,152	32534.1	10844.7	1.00	10,845	17,475
5989.00	29,981	68138.8	22712.9	1.00	22,713	40,188
5990.00	32,693	93981.6	31327.2	1.00	31,327	71,515
5991.00	35,507	102271.0	34090.3	1.00	34,090	105,605
5992.00	42,544	116917.6	38972.5	1.00	38,973	144,578
5993.00	46,080	132900.7	44300.2	1.00	44,300	188,878

# Pond A Stage-Storage

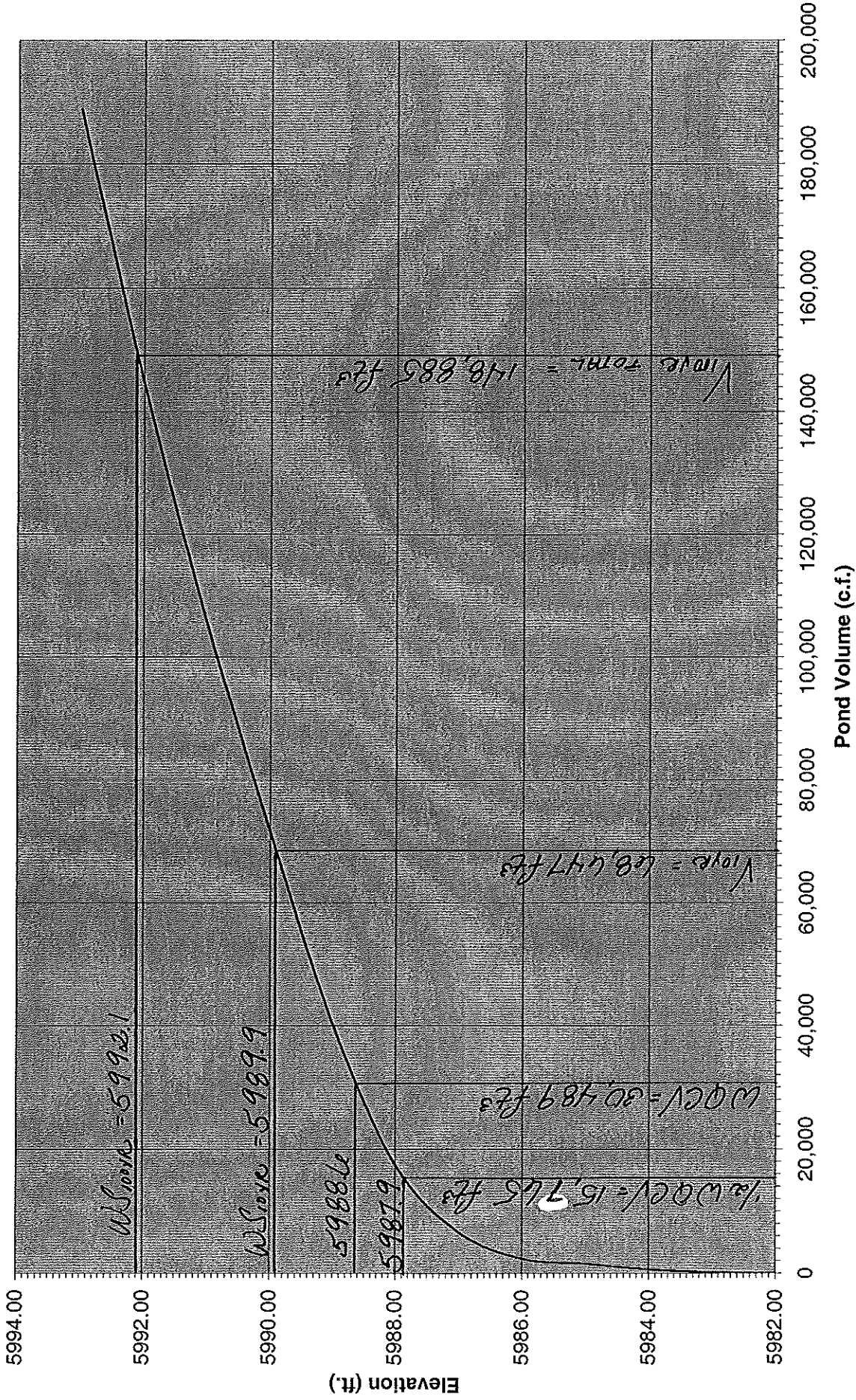

## Emergency Spillway Weir Calculations

Project Name: Parker 234  
Project No. 1804102  
Calculated By: MEF  
Checked By: KAL  
Date: 1/31/03

### Weir Equation:

$$Q = C * L * (H)^{3/2}$$

$C_d = 3.37$  (trapezoidal weirs)

Note: Weirs are designed to pass 2x the 100yr. tributary flow.  
(Refer to SF-3 form)

### Pond A Emergency Spillway

Flow Rate (2\*Q<sub>100</sub>) = 383.4 cfs  
Top of Berm Elevation = 5995.00 feet      Freeboard = 1.00  
Emergency Spillway Elevation = 5994.00 feet  
100 yr. Water Surface Elevation = 5992.10 feet  
Height (H) = 1.90 feet  
Length (D) = 43.48 feet

### Pond B Emergency Spillway

Flow Rate (2\*Q<sub>100</sub>) = 353.1 cfs  
Top of Berm Elevation = 6089.00 feet      Freeboard = 1.00  
Emergency Spillway Elevation = 6088.00 feet  
Bottom of Berm Elevation\* = 6086.00 feet      \*100 yr. W.S. Elevation = 6083.8 feet  
Height (H) = 2.00 feet  
Length (D) = 37.08 feet

### Pond C Emergency Spillway

Flow Rate (2\*Q<sub>100</sub>) = 58.1 cfs  
Top of Berm Elevation = 6118.00 feet      Freeboard = 1.00  
Emergency Spillway Elevation = 6117.00 feet  
100 yr. Water Surface Elevation = 6116.20 feet  
Height (H) = 0.80 feet  
Length (D) = 24.13 feet

### Pond D Emergency Spillway

Flow Rate (2\*Q<sub>100</sub>) = 160.0 cfs  
Top of Berm Elevation = 6050.50 feet      Freeboard = 1.00  
Emergency Spillway Elevation = 6049.50 feet  
100 yr. Water Surface Elevation = 6048.50 feet  
Height (H) = 1.00 feet  
Length (D) = 47.53 feet

# Circular Orifice Sizing

**Pond A**

**DATA:**

Flow Rate (Q) = 25.71 cfs  
 Water Surface Elevation = 5992.10 feet  
 Invert of Orifice = 5981.80 feet  
 Height of water surface = 10.30 feet  
 to invert of orifice (Y)  
 Diameter of Orifice (D) = 1.42 feet  
 Height of water surface = 10.30 feet  
 to centroid of orifice (h)  
 $C_d = 0.65$  for circular orifices  
 $g = 32.20 \text{ ft/s}^2$

Project Name: Parker 234  
 Project No. 1804102  
 Calculated By: MEF  
 Checked By: KAL  
 Date: 01/31/03

**Orifice Equation:**

$$Q = C_d * A * (2gh)^{1/2}$$

$$Q = C_d * 3.1415 * D^2 / 4 * (2gh)^{1/2}$$

$$Q = 0.65 * 3.1415 * D^2 / 4 * (2 * 32.2 * h)^{1/2}$$

$$D = (Q / (.5105 * (64.4 * h)^{1/2}))^{1/2}$$

Calculation Table for Orifice Size

%	h = %*Y	Diam. (D)	Actual h	h/Y
98%	10.09	1.41	9.60	93%
97%	9.99	1.41	9.60	93%
96%	9.89	1.41	9.59	93%
95%	9.79	1.42	9.59	93%
94%	9.68	1.42	9.59	93%
93%	9.58	1.42	9.59	93%
92%	9.48	1.43	9.59	93%
91%	9.37	1.43	9.58	93%
90%	9.27	1.44	9.58	93%
89%	9.17	1.44	9.58	93%
88%	9.06	1.44	9.58	93%
87%	8.96	1.45	9.58	93%
86%	8.86	1.45	9.57	93%
85%	8.76	1.46	9.57	93%
84%	8.65	1.46	9.57	93%
83%	8.55	1.47	9.57	93%
82%	8.45	1.47	9.57	93%
81%	8.34	1.47	9.56	93%
80%	8.24	1.48	9.56	93%
79%	8.14	1.48	9.56	93%
78%	8.03	1.49	9.56	93%

N:\Projects\1804102\dwg\16-PondA.dwg, 02/07/2003 09:52:58 AM, IIC\_VLHP8000, JAM

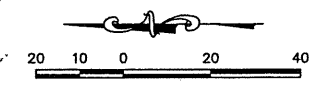
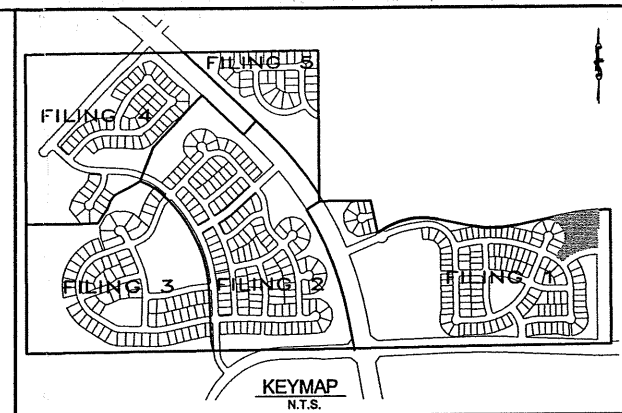
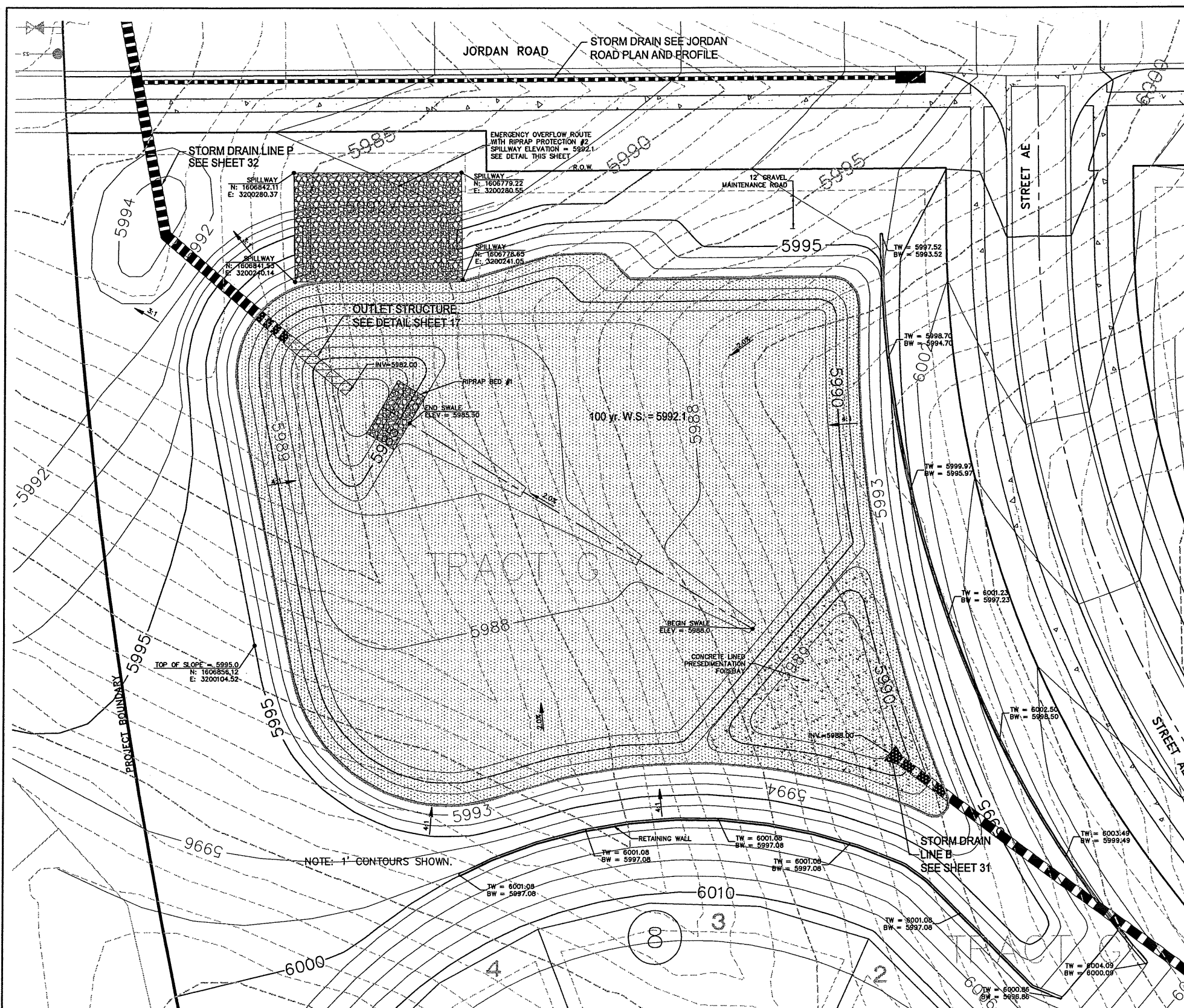

**RIRAP SUMMARY TABLE**

	RR#1	RR#2
LENGTH	23	61'
WIDTH	12	40'
DEPTH	2.5'	1.5'
SIZE d50	9"	12"
TYPE	L	M

\* SEE DETAIL

BURY TYPE L RIPRAP WITH 4" NATIVE TOPSOIL AND RESEED OR RESOD.

**POND SUMMARY TABLE**

	Q 10yr.	Q 100yr.
PEAK INFLOW (cfs)	127.4	191.7
PEAK OUTFLOW (cfs)	7.0	50.9
WQCV (Ac.Ft.)		0.68
10 yr. REQUIRED VOL. (Ac.Ft.)		1.55
100 yr. REQUIRED VOL. (Ac.Ft.)		2.72
DETENTION CAPACITY (Ac.Ft.)		3.42
AVAILABLE FREEBOARD (ft.)		1.0

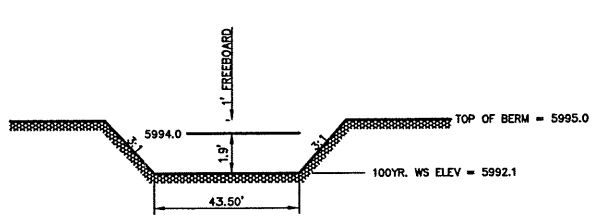

**EMERGENCY SPILLWAY DETAIL**

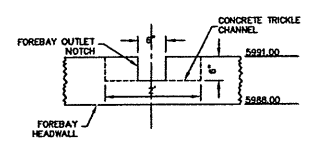

**FOREBAY OUTLET NOTCH**

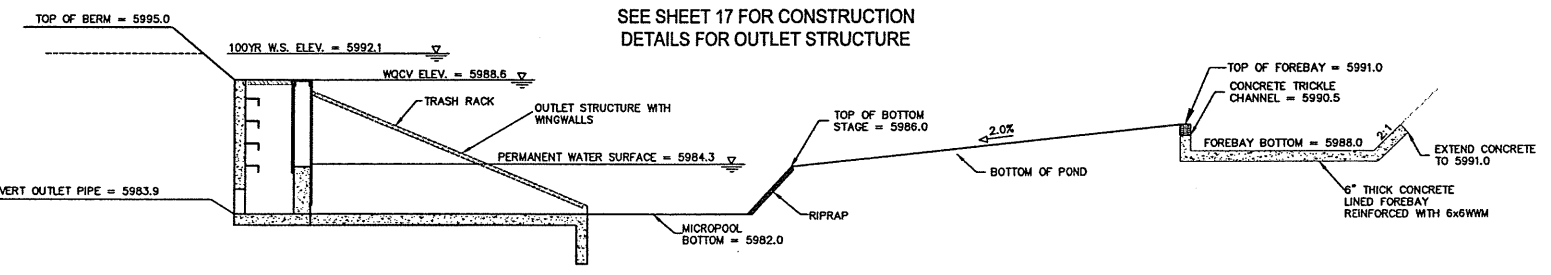

No.	Date	Appr.	Date	Revisions

7901 E. Industrial Avenue  
Suite 150  
Englewood, CO 80111  
Tel: (720) 482-9526  
Fax: (720) 482-9546

**UNCC**  
CONSULTANTS OF COLORADO, INC.  
CIVIL ENGINEERING - LAND SURVEYING - LAND PLANNING

Continental Homes  
7600 East Orchard Road, Ste. 165-S  
Greenwood Village, CO 80111

DOUGLAS 234  
FILING 1  
STREET AND DRAINAGE IMPROVEMENTS  
POND A

SCALE: AS SHOWN  
FILE NO: 01804102  
DATE: FEBRUARY 2003

DRAWN BY: JAM  
CHECKED BY: KAL  
DATE: FEBRUARY 2003

SHEET NUMBER **16**

CALL UNCC  
TWO WORKING DAYS  
BEFORE YOU DIG  
1-800-922-1987  
534-6700 METRO DENVER AREA  
UTILITY NOTIFICATION CENTER OF COLORADO

DRAWING: 16-PondA

# POND A DETAILS

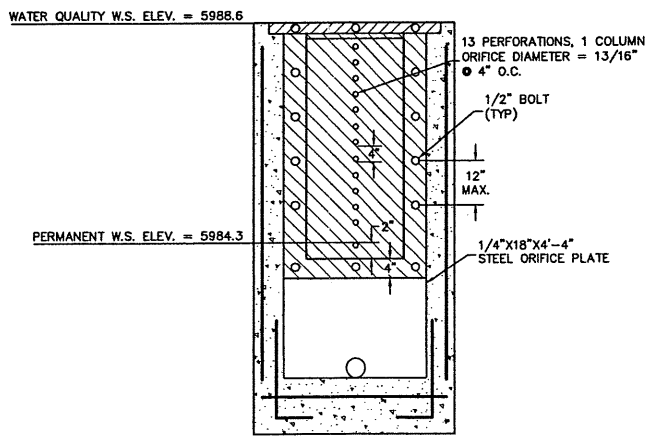
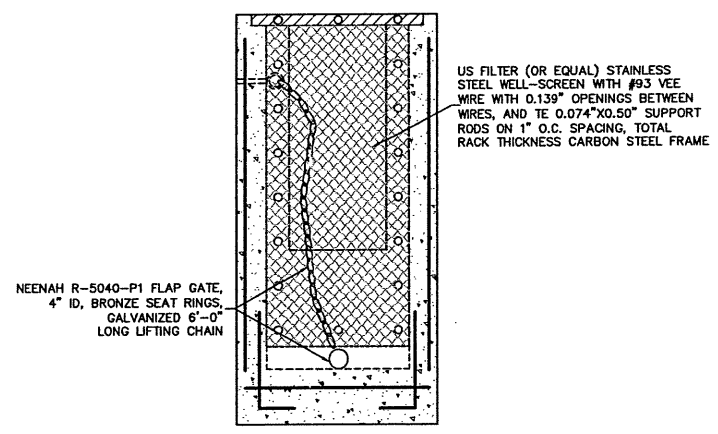
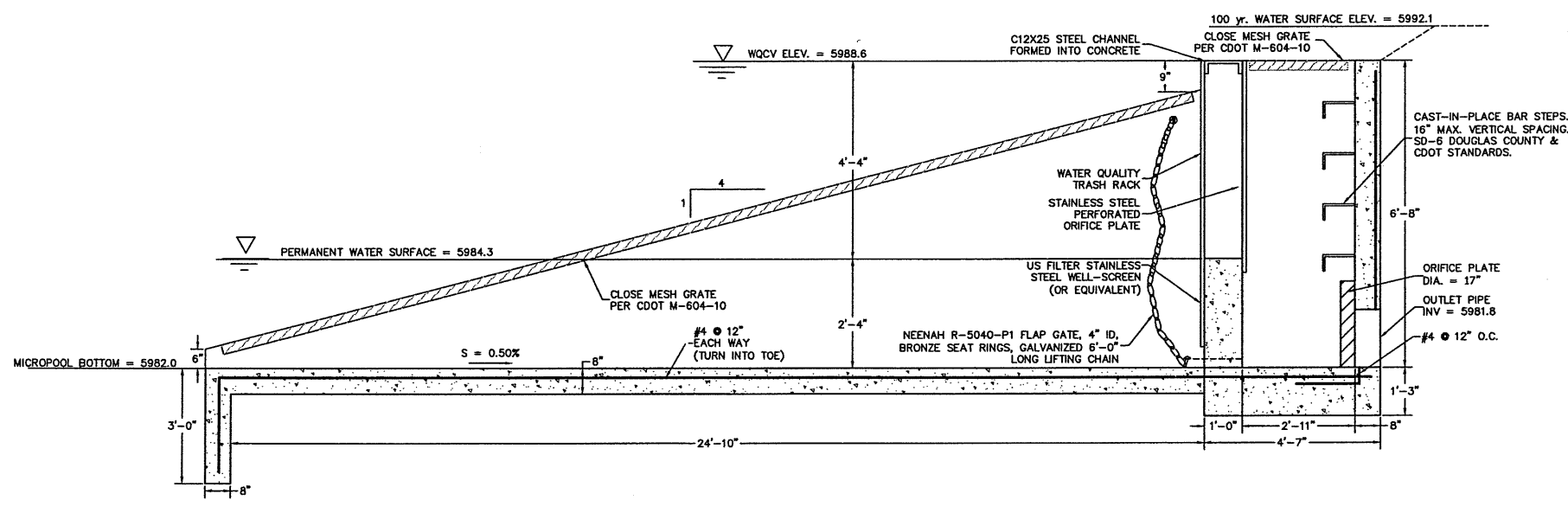
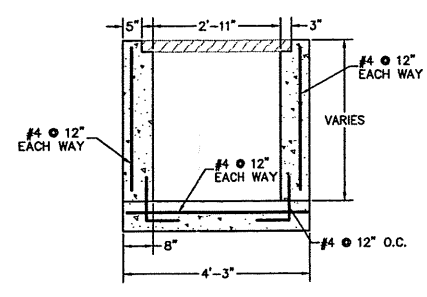
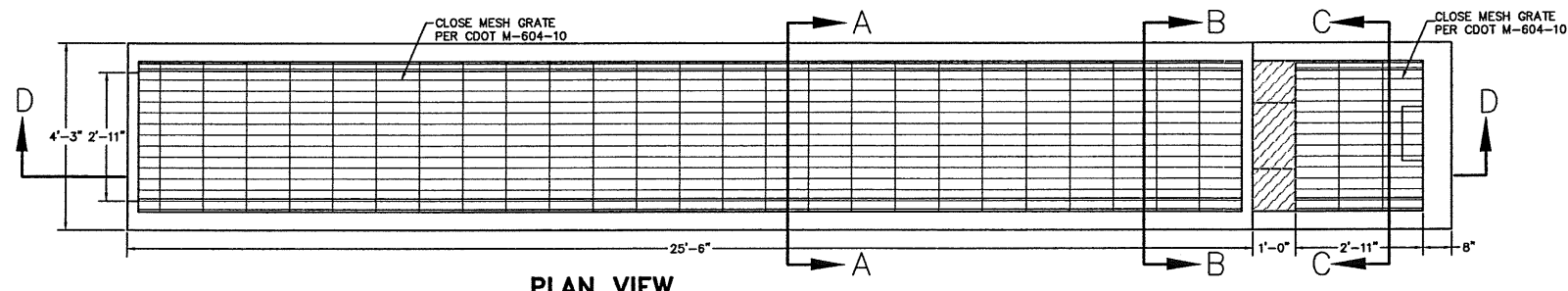

SHEET NUMBER <b>17</b>	DRAWN BY: MEF	CHECKED BY: KAL	DATE: FEBRUARY 2005	SCALE: AS SHOWN	FILE NO: 01804102	DOUGLAS 234 FILING 1 STREET AND DRAINAGE IMPROVEMENTS POND A OUTLET DETAILS	Continental Homes 7600 East Orchard Road, Ste. 165-S Greenwood Village, CO 80111	 CONSULTANTS OF COLORADO, INC. CIVIL ENGINEERING · LAND SURVEYING · LAND PLANNING	7901 E. Bellevue Avenue Greenwood, CO 80111 Tel: (720) 482-9236 Fax: (720) 482-9546	Revisions	Date	Appr.	Date
				No.	No.					No.	No.		

N:\Projects\01804102\dwg\Preliminary\Filing1\Town-of-Parker\17-PONDA-DET.dwg, 02/07/2003 09:53:51 AM, IIC\_VLHP8000, JAM

DRAWING: 17-PONDA-DET

**Appendix C**  
**Drainage Plan**

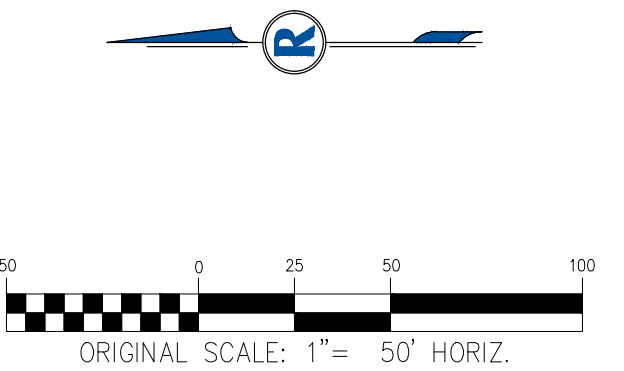
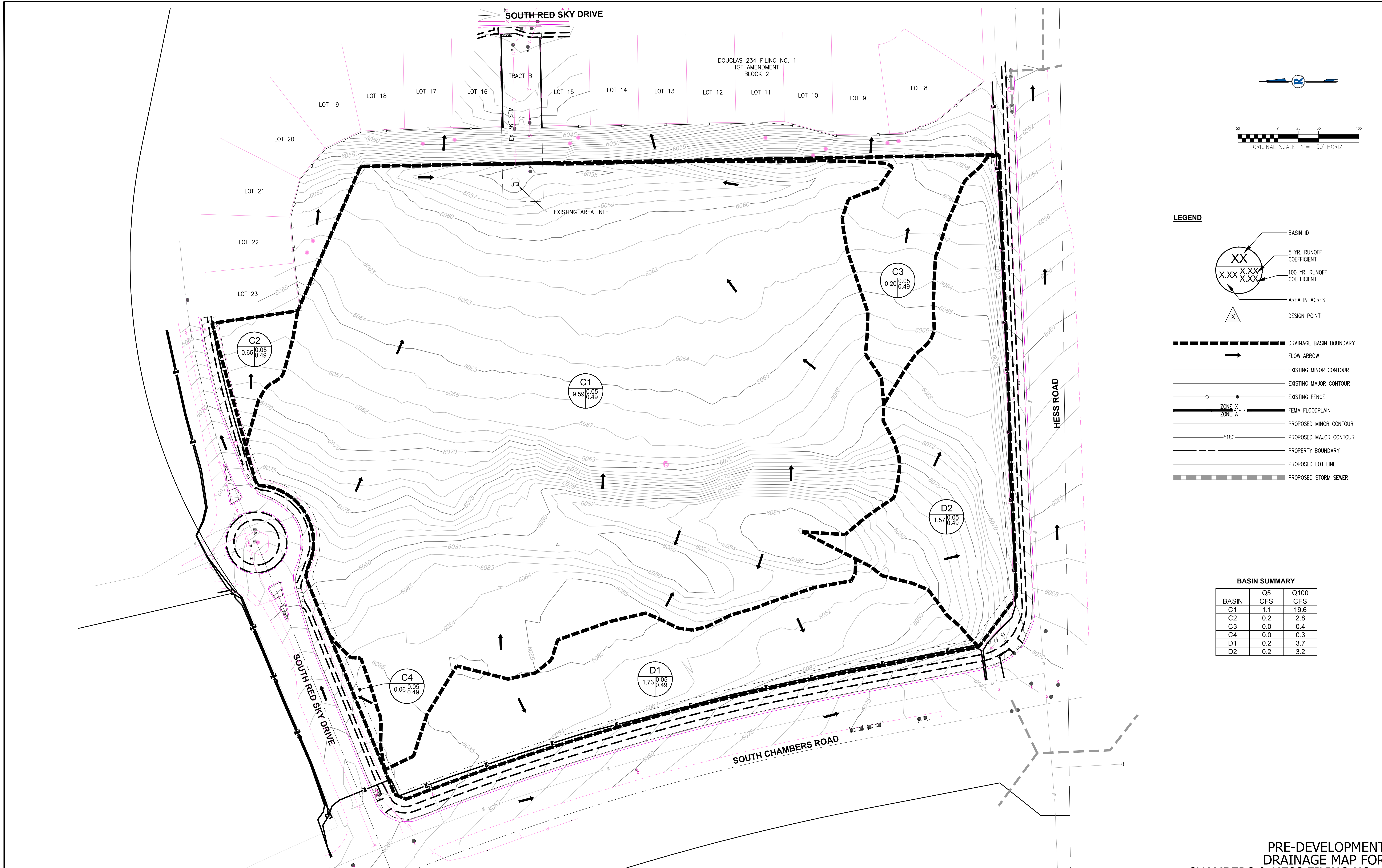

**LEGEND**

- BASIN ID
- 5 YR. RUNOFF COEFFICIENT
- 100 YR. RUNOFF COEFFICIENT
- AREA IN ACRES
- DESIGN POINT
- DRAINAGE BASIN BOUNDARY
- FLOW ARROW
- EXISTING MINOR CONTOUR
- EXISTING MAJOR CONTOUR
- EXISTING FENCE
- FEMA FLOODPLAIN
- PROPOSED MINOR CONTOUR
- PROPOSED MAJOR CONTOUR
- PROPERTY BOUNDARY
- PROPOSED LOT LINE
- PROPOSED STORM SEWER

**BASIN SUMMARY**

BASIN	Q5 CFS	Q100 CFS
C1	1.1	19.6
C2	0.2	2.8
C3	0.0	0.4
C4	0.0	0.3
D1	0.2	3.7
D2	0.2	3.2

**RICK** ENGINEERING COMPANY  
 9801 EAST EASTER AVE  
 CENTENNIAL, CO 80112  
 303.537.8020  
 rickengineering.com  
 Denver - San Diego - Sacramento - Riverside - Orange - San Luis Obispo - Phoenix

D-1173  
 DATE: DEC 13, 2019

SHEET 1 OF 2

NOT FOR CONSTRUCTION – EXHIBIT FOR DRAINAGE STUDY REPORT ONLY

© 2019 RICK ENGINEERING COMPANY

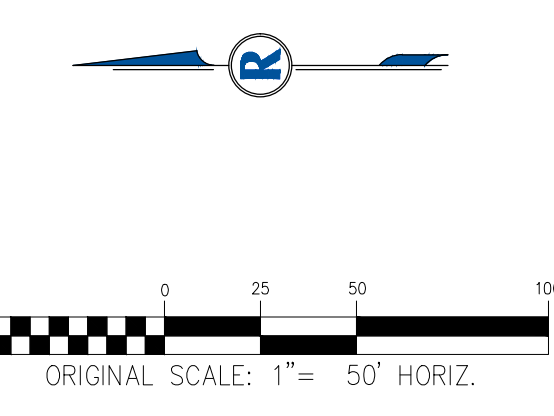

**LEGEND**

- XX BASIN ID
- X.XX 5 YR. RUNOFF COEFFICIENT
- X.XX 100 YR. RUNOFF COEFFICIENT
- X.XX AREA IN ACRES
- X DESIGN POINT
- DRAINAGE BASIN BOUNDARY
- FLOW ARROW
- EXISTING MINOR CONTOUR
- EXISTING MAJOR CONTOUR
- PROPOSED MINOR CONTOUR
- PROPOSED MAJOR CONTOUR
- PROPERTY BOUNDARY
- PROPOSED LOT LINE
- PROPOSED STORM SEWER

DESIGN POINT SUMMARY			BASIN SUMMARY		
DESIGN POINT	PEAK RUNOFF		BASIN	Q5 CFS	Q100 CFS
	5YR (CFS)	100YR (CFS)			
1	2.8	6.4	A1	2.8	6.4
2	4.7	10.8	A2	2.0	4.6
3	8.1	18.6	A3	3.6	8.2
4	10.6	24.3	A4	2.7	6.2
5	12.7	29.3	A5	2.5	5.7
6	5.3	12.0	A6	5.3	12.0
7	7.6	17.3	A7	2.4	5.5
8	9.4	21.4	A8	1.9	4.2
9	2.4	8.2	A9	1.7	4.7
10	1.6	4.3	A10	1.6	4.3
11	11.2	28.9	A11	2.2	5.0
12	20.9	51.4	A12	4.2	9.6
13	22.1	54.4	A13	4.9	11.1
14	4.2	9.6	A14	0.1	1.8
15	28.6	69.5	HESS1	3.5	7.8
16	28.7	70.8	HESS2	0.2	0.5
17	3.6	9.1	RSD1	0.9	1.9
			OS1	0.1	1.4

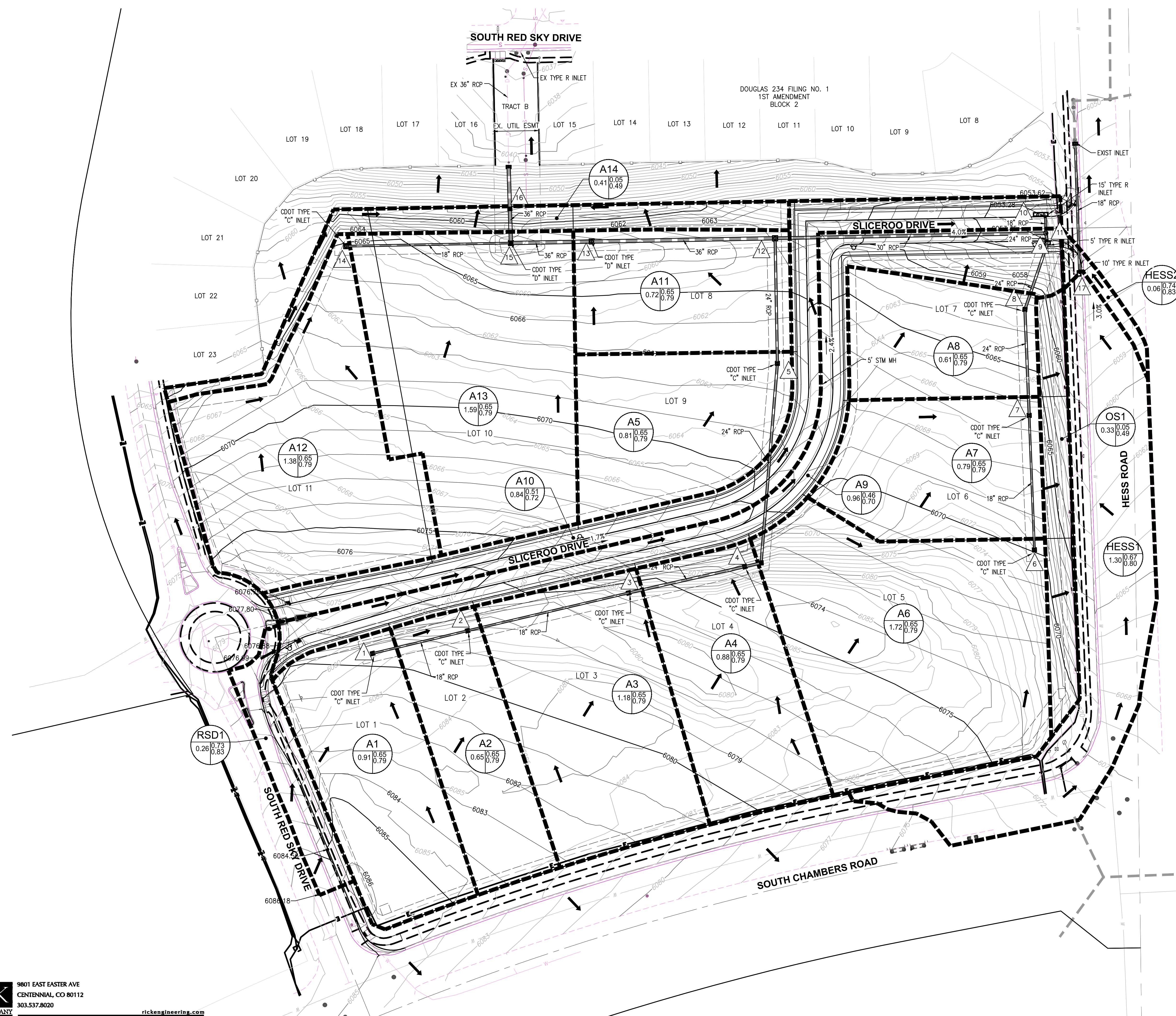

**RICK ENGINEERING COMPANY**  
 9801 EAST EASTER AVE  
 CENTENNIAL, CO 80112  
 303.537.8020  
 rickengineering.com  
 Denver • Tucson • San Diego • Sacramento • Riverside • Orange • San Luis Obispo • Phoenix

POST-DEVELOPMENT DRAINAGE MAP FOR CHAMBERS & HESS FILING NO. 1

NOT FOR CONSTRUCTION – EXHIBIT FOR DRAINAGE STUDY REPORT ONLY

D-1173  
 DATE: JANUARY 25, 2021

© 2021 RICK ENGINEERING COMPANY