

---

# **TRAFFIC IMPACT REPORT**

## **LINCOLN & DRANSFELDT PARKER, COLORADO**

**September 28, 2020**

Prepared for:  
Plaza Street Partners  
2400 W 75<sup>th</sup> St., Suite 220  
Prairie Village, KS 66208

Prepared by:



1120 Lincoln Street  
Denver, CO 80203  
Ph: 303-623-6300

Harris Kocher Smith Project No. 200829

---

## TABLE OF CONTENTS

I.	INTRODUCTION.....	3
A.	Project Overview.....	3
B.	Purpose of Study.....	3
C.	Study Area.....	3
II.	EXISTING CONDITIONS.....	3
A.	Existing Traffic Volumes.....	3
B.	Existing Roadway System.....	4
III.	BACKGROUND TRAFFIC.....	6
A.	Background Traffic Volumes.....	6
B.	Background Traffic Operational Analysis.....	6
IV.	PROJECT DEVELOPMENT.....	7
A.	Trip Generation.....	7
B.	Trip Distribution.....	7
C.	Trip Assignment.....	7
V.	TOTAL TRAFFIC.....	8
VI.	PROJECT ANALYSIS.....	8
A.	Operational Analysis.....	8
B.	Queue Lengths and Storage Required.....	11
C.	Safety Analysis.....	12
VII.	SUMMARY.....	12

## LIST OF TABLES

Table 1: Trip Generation.....	7
Table 2: Summary of Results – Intersection Capacity Analysis.....	10
Table 3: Summary of Results – Queue Storage.....	12
Table 4: Summary of Recommendations.....	13

## **FIGURES**

- 1 Site Location Map
- 2 Conceptual Site Plan
- 3 2020 Existing Traffic Volumes
- 4 2023 Background Traffic Volumes
- 5 2040 Background Traffic Volumes
- 6 2020 Existing Traffic Operational Conditions
- 7 2023 Background Traffic Operational Conditions
- 8 2040 Background Traffic Operational Conditions
- 9 Site-Generated Trip Distribution
- 10 Site-Generated Trip Assignment
- 11 Peak Hour Pass-By Trips
- 12 2023 Total Traffic Volumes
- 13 2040 Total Traffic Volumes
- 14 2023 Total Traffic Operational Conditions
- 15 2040 Total Traffic Operational Conditions
- 16 Dransfeldt Rd. Conceptual Improvement Layout

## **APPENDIX "A" 2020 EXISTING TRAFFIC VOLUME COUNTS**

## **APPENDIX "B" INTERSECTION CAPACITY ANALYSIS WORKSHEETS**

## I. INTRODUCTION

### A. Project Overview

Plaza Street Partners is proposing to develop a parcel of land containing approximately 7.82 acres of mostly undeveloped land. The subject parcel is situated south of Lincoln Avenue, east of Dransfeldt Road and west of Parker Road. The property is within the jurisdictional boundaries of Parker, Colorado. At buildout, the planned Lincoln & Dransfeldt development will contain a super convenience market/gas station with 12 pumps, 3 fast-food restaurants with drive-thru windows, an automated carwash, and a quick lubrication vehicle shop. The property is bounded on the south by a small office building and a light industrial land use, on the east by a Walgreens and NAPA Auto Parts which border S. Parker Rd., on the north by Lincoln Ave., and on the west by Dransfeldt Rd. Figure 1 provides a site location map of the proposed project and surrounding transportation system.

The proposed development will have two access points. The primary access point will intersect Dransfeldt Road opposite the existing Lowes access driveway near the southwest corner of the site. The secondary access point will intersect the existing Walgreens/Lincoln Ave. access road near the northeast corner of the site. The layout of the site plan has preserved the ability for additional cross access points along the southern and eastern borders of the parcel to be implemented in the future. Figure 2 illustrates the conceptual site plan for the development.

### B. Purpose of Study

The purpose of this study is to evaluate the impacts of the vehicular trips projected to be generated by the proposed Lincoln & Dransfeldt development on the study area intersections and roadway system. The study includes 2020 (existing), 2023 (year of anticipated build-out), and 2040 (long-range horizon year) analysis horizons.

### C. Study Area

The study area encompasses the existing roadway system in the vicinity of the project site. Specifically, the following existing intersections are included in the study:

- Lincoln Ave./Dransfeldt Rd.
- Lincoln Ave./Walgreens Access
- Lincoln Ave./S. Parker Rd.
- Dransfeldt Rd./Lowe's Access

## II. EXISTING CONDITIONS

### A. Existing Traffic Volumes

Existing peak hour intersection turning movement traffic volume counts were collected for this study at the following intersections on Thursday, September 3, 2020:

- Lincoln Ave./Dransfeldt Rd.
- Lincoln Ave./Walgreens Access
- Lincoln Ave./Parker Rd.
- Dransfeldt Rd./Lowe's Access

24-hour directional traffic volume counts were collected for this study at the following locations on September 3, 2020:

- Dransfeldt Rd. south of Lincoln Ave. (west boundary of development)
- Lincoln Ave. east of Dransfeldt Rd. (north boundary of development)

A review of other recent traffic volume counts at the study area intersections, as well as conversations with Town of Parker staff, indicate that traffic has essentially returned to pre-COVID-19 pandemic levels and applying a COVID-19 factor is not necessary.

A summary of the existing (2020) peak hour intersection turning movement traffic volume counts and 24-hour directional traffic volume counts collected for this study are illustrated in Figure 3. Detailed traffic volume count data is provided in Appendix "A".

## B. Existing Roadway System

The existing transportation network in the vicinity of the subject property is graphically illustrated in Figure 1. The following narrative provides a description of the study area roadways and associated intersections as they currently exist in 2020:

### Study Area Roadways:

- **Lincoln Ave.** is classified as a major arterial roadway under the jurisdiction of the Town of Parker. Within the study area, the roadway section consists of two travel lanes in each direction with continuous right turn lanes and a striped center median between Dransfeldt Rd. and Parker Rd. There is curb and gutter, and sidewalk on both sides of the roadway. There is a striped center median. The posted speed limit is 40 mph within the study area.
- **Dransfeldt Rd.** is classified as a major collector, under the jurisdiction of the Town of Parker. Within the study area, the roadway section consists of one travel lane in the southbound direction and two travel lanes in the northbound direction. There is a continuous center two-way left turn lane south of the Lowe's access intersection. There is curb and gutter, and attached sidewalk on both sides of the roadway. The posted speed limit is 35 mph within the study area.
- **S. Parker Rd. (SH 83)** is classified as a non-rural principal arterial (NR-A) under the jurisdiction of the Colorado Department of Transportation (CDOT). Within the study area, the roadway section consists of three travel lanes in each direction with a raised center median, and auxiliary turn lanes at intersections. There is curb and gutter, and attached sidewalk on both sides of the roadway. The posted speed limit is 45 mph within the study area.
- **Walgreens Access** is a private drive connecting Lincoln Ave to the Walgreens parking lot. This pavement section has one travel lane in each direction with no striping.
- **Lowe's Access** is a private drive connecting the Lowe's parking lot to Dransfeldt Rd. This pavement section has one travel lane in each direction and no striping.

### Study Area Intersections:

- The **Lincoln Ave./Dransfeldt Rd.** intersection is a four-legged signalized intersection operating under actuated/coordinated control with split phasing on the northbound and

southbound approaches and protected/permitted left turn phasing on the eastbound and westbound approaches. The west leg of the intersection has one left turn lane with approximately 200 feet of storage, two through lanes and one continuous right turn auxiliary lane on the eastbound approach, and two westbound departure lanes plus one continuous right turn auxiliary lane. The east leg of the intersection has one left turn lane with approximately 400 feet of storage, two through lanes and one continuous right turn auxiliary lane on the westbound approach, and two eastbound departure lanes plus one eastbound continuous right turn auxiliary lane. The north leg of the intersection has one left turn lane with approximately 100 feet of storage, one through lane and one right turn lane on the southbound approach, and one northbound departure lane. The south leg of the intersection has one left turn lane with approximately 300 feet of storage, one shared left/through lane and one right turn lane on the northbound approach, and one southbound departure lane.

- The **Lincoln Ave./Walgreens Access** intersection is a four-legged intersection operating under stop sign control on the northbound and southbound approaches. The west leg of the intersection has two through lanes and one continuous right turn auxiliary lane on the eastbound approach, and two westbound departure lanes plus a continuous right turn auxiliary lane. The east leg of the intersection has two through lanes and one continuous right turn auxiliary lane on the westbound approach, and two eastbound departure lanes plus a continuous right turn auxiliary lane. The north leg of the intersection is a right-in/ right-out (RIRO) access for the adjacent shopping center. It has one southbound right turn lane and one northbound departure lane. The south leg of the intersection has one shared left/right turn lane on the northbound approach and one southbound departure lane.
- The **Lincoln Ave./S. Parker Rd (SH 83)** intersection is a signalized four-legged intersection operating under actuated coordinated control with protected only left turn phasing on all four approaches. The west leg of the intersection has dual left turn lanes with approximately a total of 700 feet storage, two through lanes and a free-flow right turn lane on the eastbound approach, and two westbound departure lanes plus a southbound to westbound right turn auxiliary lane. The east leg of the intersection has dual left turn lanes with approximately a total of 750 feet storage, two through lanes and a free-flow right turn lane on the westbound approach, and two eastbound departure lanes plus a northbound to eastbound right turn auxiliary lane. The north leg of the intersection has dual left turn lanes with approximately a total of 950 feet of storage, three through lanes and free-flow right turn lane on the southbound approach, and three northbound departure lanes plus a westbound to northbound right turn auxiliary lane. The south leg of the intersection has dual left turn lanes with approximately a total of 1,100 feet of storage, three through lanes and free-flow right turn lane on the northbound approach, and three southbound departure lanes plus an eastbound to southbound right turn auxiliary lane.
- The **Dransfeldt Rd./Lowe's Access** intersection currently exists as a "T" intersection approximately 420 feet centerline to centerline from the Lincoln Ave./Dransfeldt Rd. intersection. The intersection operates under stop sign control on the eastbound approach. The west leg of the intersection has one shared left/right turn lane, and one westbound departure lane. The north leg of the intersection has one shared through/right turn lane on the southbound approach, and two northbound departure lanes. The south leg of the intersection has one left turn lane as part of a continuous two-way left turn lane and two through lanes on the northbound approach, and one southbound departure lane.

### III. BACKGROUND TRAFFIC

#### A. Background Traffic Volumes

Background traffic volume forecasts for the 2023 (buildout) and 2040 (long-range) analysis horizons were developed for this study utilizing the following strategy:

- For the purposes of this study it is assumed that peak-hour distribution of background intersection approach traffic (left turn, through, right turn) will remain constant through the 2023 and 2040 analysis horizons.
- Utilizing the Denver Regional Council of Governments (DRCOG) travel models for 2015 and 2040 daily traffic volume forecasts it was determined that the average annual traffic volume growth rate for Lincoln Ave within the study limits is 2%. This traffic volume growth rate was applied to all peak hour existing traffic volume counts to determine the 2023 (buildout) and 2040 (long-range) background traffic volumes. A 2% growth rate equates to a 3-year growth factor (2020 to 2023) of 1.061 and a 20-year growth factor (2020 to 2040) of 1.486.

Figures 4 and 5 graphically illustrate the projected background traffic volumes for the 2023 (buildout) and 2040 (long-range) analysis horizons, respectively.

#### B. Background Traffic Operational Analysis

In order to establish a base condition in which to evaluate the impact of the traffic generated by the proposed development on the study area intersections, peak hour capacity analyses were performed for the 2020 (existing), 2023 (buildout) and 2040 (long-range) background traffic conditions. These analyses utilized the methodologies contained in the *Highway Capacity Manual 6<sup>th</sup> Edition* (HCM 6) employing *Synchro 10* software and resulted in a qualitative measure of the operational characteristics of the intersection described by a letter designation ranging from “A” to “F” known as “Level of Service” (LOS). LOS “A” represents ideal free flow operating conditions, whereas LOS “F” represents excessive congestion and delay. Un-signalized intersection capacity analysis reports a LOS designation for each impeded intersection movement. Signalized intersection capacity analysis reports the overall LOS designation for the intersection as well as for each lane group and approach. LOS “D” is considered the minimum acceptable standard of operation.

The following study area intersections were analyzed for the 2020 (existing) traffic conditions, as well as for the 2023 (buildout) and 2040 (long-range) background traffic analysis horizons:

- Lincoln Ave./Dransfeldt Rd.
- Lincoln Ave./Walgreens Access
- Lincoln Ave./S. Parker Rd.
- Dransfeldt Rd./Lowe’s Access

The results of these background traffic operational analyses are summarized graphically for the 2020 (existing) traffic conditions, as well as for the 2023 (buildout) and 2040 (long-range) background traffic analysis horizons in Figures 6, 7, and 8, respectively. A summary of the results of the intersection capacity analyses is provided in Table 2 and detailed *Synchro 10* software intersection capacity analysis reports in Appendix “B”.

## IV. PROJECT DEVELOPMENT

### A. Trip Generation

The trip-generation projections for the proposed Lincoln & Dransfeldt development were forecast using the publication *Trip Generation, 10<sup>th</sup> Edition*, by the Institute of Transportation Engineers (ITE). Estimates of total daily traffic volumes and AM and PM peak-hour traffic volumes were calculated. Trip generation reductions due to transportation demand management, internal trips, or transit use were not considered. Pass-by trip reduction was considered in the total traffic analysis scenarios, and capped at a 15% maximum pass-by trip reduction, per Town of Parker criteria.

For the purposes of this study it was assumed that the subject parcel will be fully developed by 2023 and consist of a 5,637 sf convenience market with 12 vehicle fueling stations, 3 fast-food restaurants with drive-thru windows containing 2,050 sf, 3,750 sf and 2,000 sf, respectively, an automated carwash with a single wash tunnel, and a 1,600 sf quick lubrication vehicle shop. Based on these parameters, at buildout, the proposed development is projected to generate 8,505 daily vehicle trips of which 791 are projected to be generated during the AM peak hour and 738 are projected to be generated during the PM peak hour. Trip Generation projections are provided in Table 1.

**TABLE 1**

Trip Generation										
Land Use	Intensity	ITE Code	Daily (vpd)	AM Peak Hour (vph)			PM Peak Hour (vph)			
				Total	In	Out	Total	In	Out	
Super Convenience Market/Gas Station With 12 Pumps	5.64	TSF	960	4721	469	235	234	391	196	195
Fast-Food Restaurant W/ Drive-Thru Window	2.05	TSF	934	965	82	41	41	67	34	33
Fast-Food Restaurant W/ Drive-Thru Window	3.75	TSF	934	1766	151	77	74	123	63	60
Fast-Food Restaurant W/ Drive-Thru Window	2	TSF	934	942	80	40	40	65	33	32
Automated Car Wash	1	Wash Tunnel	948	-	-	-	-	78	39	39
Quick Lubrication Vehicle Shop	1.6	TSF	941	111	9	7	2	14	5	9
<b>Grand Total</b>				<b>8,505</b>	<b>791</b>	<b>400</b>	<b>391</b>	<b>738</b>	<b>370</b>	<b>368</b>

### B. Trip Distribution

The distribution of the estimated vehicle trips generated by the proposed development were established based on the current and projected future traffic patterns on the surrounding transportation system, efficiency of access to the principal transportation corridors serving the proposed development, and the potential trip origins/destinations for the proposed land uses within the development. Figure 9 illustrates the projected trip-distribution patterns for the development.

### C. Trip Assignment

The vehicular traffic volumes estimated to be generated by the proposed Trip Generation projections shown in Table 1 were assigned to the study area roadways and intersections utilizing the trip distribution methodology described above. Figure 10 illustrates the site generated trip assignment for the development.

## V. TOTAL TRAFFIC

Total traffic forecasts for the 2023 (buildout) and 2040 (long-range) analysis horizons were computed by combining the associated 2023 (buildout) and 2040 (long-range) background traffic volumes with the projected site generated traffic volumes. Pass-by trip reductions were considered in the total traffic analysis, and capped at a 15% maximum pass-by trip reduction per Town of Parker criteria. Figure 11 illustrates the peak hour pass-by trip assignment. Figures 12 and 13 graphically illustrate the total traffic projections for the study area intersections for the 2023 (buildout) and 2040 (long-range) analysis horizons, respectively.

## VI. PROJECT ANALYSIS

### A. Operational Analysis

In order to evaluate the impact of the proposed Lincoln & Dransfeldt development on the study area roadway system, peak hour intersection capacity analyses for total traffic conditions (with proposed development traffic) were performed for the 2023 (buildout) and 2040 (long-range) analysis horizons at each of the study area intersections listed below.

- Lincoln Ave./Dransfeldt Rd.
- Lincoln Ave./Walgreens Access
- Lincoln Ave./S. Parker Rd.
- Dransfeldt Rd./Lowe's Access/Site Access

A narrative of the summary of the analysis and comparison to background traffic conditions for the 2023 (buildout) and 2040 (long-range) analysis horizons is provided below. The results of the total-traffic operational analysis are summarized graphically for the 2023 (buildout) and 2040 (long-range) analysis horizons in Figures 14 and 15, respectively. A summary of the results of the intersection capacity analysis is provided in Table 2 and detailed *Synchro 10* software intersection capacity analysis reports in Appendix "B".

### Study-Area Intersections – Summary of Results:

- **Lincoln Ave./Dransfeldt Rd.** – The Lincoln Ave./Dransfeldt Rd. intersection, overall, currently operates at a poor level of service (LOS "E") during the PM peak hour with the eastbound through and westbound left turn movements experiencing poor to failing levels of service (LOS "E" to LOS "F"). Based on the existing intersection layout and split phasing on the northbound and southbound approaches, this intersection is projected to continue experiencing poor overall levels of service during the PM peak hour through the 2040 (long-range) analysis horizon due to high background traffic volumes on Lincoln Ave. By the 2040 (long-range) analysis horizon, Lincoln Ave. is anticipated to be widened to have an additional through lane in each direction, per the *Town of Parker Master Transportation Plan*, improving the eastbound and westbound approach delay times.

In order to improve operations and accommodate the proposed Lincoln & Dransfeldt development this intersection is anticipated to undergo the following geometric and operational improvements. The east, west and north legs of the intersection will not require any geometric improvements. The south leg of the intersection should be widened to have dual northbound left turn lanes providing a minimum total of 400 feet of storage, one through lane and one right turn lane on the northbound approach, and two southbound departure lanes. Operational improvements should include removing the

split phased signal timing and implementing protected/permitted left turn phasing on the northbound and southbound approaches. Also, the northbound right turn movement should have permitted/overlap phasing in order to minimize the projected right turn queues. Based on these parameters and the existing and forecast background and total traffic volumes, it is projected that the intersection, overall, as well as all lane groups will operate at acceptable levels of service through the 2023 (buildout) analysis horizon with the exception of the eastbound through and westbound left turn movements. This is primarily due to the high background traffic volumes on Lincoln Ave. By the 2040 (long-range) analysis horizon it is anticipated that the operation of the intersection, overall, will deteriorate to a failing level of service during the PM peak hour due to the significant growth in background traffic. A potential improvement to mitigate the poor PM peak hour operational performance of the intersection could be to add a second westbound left turn lane. This improvement is projected to improve the overall operational performance of the intersection to an acceptable level of service (LOS "D" or better) during the PM peak hour.

- **Lincoln Ave./Walgreens Access** – The Lincoln Ave./Walgreens Access intersection currently operates at acceptable levels of service in its existing configuration under stop sign control and is projected to continue to do so under background traffic conditions through the 2040 (long-range) analysis horizon with the exception of the northbound right turn movement which is projected to deteriorate to LOS "E" during the PM peak hour. Under total traffic conditions the northbound right turn movement is projected to fall to LOS "E" during the PM peak hour by the 2023 (buildout) analysis horizon and during the AM peak hour by the 2040 (long-range) analysis horizon. This is a result of the high eastbound through background traffic volumes on Lincoln Ave.

Based on the traffic counts collected at this intersection, a number of vehicles were recorded making illegal northbound to westbound left turns at this intersection (see Figure 3). As a result it is recommended that appropriate signage and pavement markings be installed to prohibit the northbound left turn movement. No other geometric or operational improvements are required at this intersection.

- **Lincoln Ave./Parker Rd.** – The Lincoln Ave./Parker Rd. intersection currently operates at LOS "D" during the AM peak hour and LOS "E" during the PM peak hour with multiple lane groups failing during both peak hour periods. This is a result of the high traffic volumes utilizing this intersection. Based on the *Town of Parker Master Transportation Plan*, Lincoln Ave. is anticipated to be widened to have an additional through lane in each direction by the 2040 (long-range) analysis horizon. Even with these improvements the overall operation of the intersection, as well as multiple lane groups are projected to continue to deteriorate.
- **Dransfeldt Rd./Lowe's Access/Site Access** – The Dransfeldt Rd./Lowe's Access intersection currently operates at acceptable conditions and will continue to do so throughout the 2040 (long-range) background traffic scenario.

Concurrently, with the development of the Lincoln & Dransfeldt project the west leg of the intersection will be constructed and serve as the primary access point for the proposed development. The addition of the west leg of the intersection will require the following improvements. The intersection will have stop sign control on the eastbound and westbound approaches. The west leg of the intersection will not require any modifications. The east leg of the intersection will have one shared left turn/through lane and one right turn lane on the westbound approach, and one eastbound departure lane. The north leg of the intersection will be constructed to have one southbound left turn

lane with 50 feet of storage, one through lane and one shared through/right turn lane on the southbound approach, and two northbound departure lanes. The south leg of the intersection will have one left turn lane, one through lane and one shared through/right turn lane on the northbound approach, and two southbound departure lanes. Based on these parameters, the northbound and southbound left turn movements are projected to operate with acceptable levels of service through the 2040 (long-range) analysis horizon total traffic scenario. However, the eastbound shared left turn/through/right turn movement and the westbound shared left turn/through movement are projected to have failing levels of service.

**TABLE 2  
SUMMARY OF RESULTS - INTERSECTION CAPACITY ANALYSIS**

INTERSECTION	INTERSECTION CONTROL	2020 EXISTING TRAFFIC		2023 BACKGROUND TRAFFIC		2023 TOTAL TRAFFIC		2040 BACKGROUND TRAFFIC		2040 TOTAL TRAFFIC	
		AM PEAK	PM PEAK	AM PEAK	PM PEAK	AM PEAK	PM PEAK	AM PEAK	PM PEAK	AM PEAK	PM PEAK
		LOS	LOS	LOS	LOS	LOS	LOS	LOS	LOS	LOS	LOS
<b>1. Lincoln Ave. &amp; Dransfeldt Rd.</b> a. EB L (Prot+Perm) b. EB T c. EB R d. WB L (Prot+Perm) e. WB T f. WB R g. NB L (Split) h. NB LT (Split) i. NB L (Dual) (Prot+Perm) j. NB T k. NB R (Perm) l. NB R (Perm+ov) m. SB L (Split) n. SB L (Prot+Perm) o. SB T p. SB R q. <b>INTERSECTION</b>	<b>Signal</b>	D	D	D	D	D	C	D	C	D	C
		D	F	D	F	E	F	D	F	E	F
		D	D	D	D	D	C	D	D	D	D
		D	E	D	E	F	F	D	F	F	F
		E	D	E	D	D	C	D	D	D	D
		C	C	C	C	C	B	C	C	C	C
		D	D	D	D	-	-	D	D	-	-
		D	D	D	D	-	-	D	D	-	-
		-	-	-	-	C	D	-	-	C	C
		-	-	-	-	D	D	-	-	D	C
		D	D	D	E	-	-	D	F	-	-
		-	-	-	-	C	D	-	-	C	D
		D	D	D	D	-	-	D	D	-	-
		-	-	-	-	C	C	-	-	C	C
		D	D	D	D	D	D	D	D	D	C
		D	D	D	D	D	D	D	D	D	D
	D	E	D	F	D	D	D	E	D	F	
<b>2. Lincoln Ave. &amp; Walgreens Access</b> a. EB TR b. WB TR c. NB LR d. NB R e. SB R f. <b>INTERSECTION</b>	<b>TWSC</b>	A	A	A	A	A	A	A	A	A	A
		A	A	A	A	A	A	A	A	A	A
	Stop	C	C	-	-	-	-	-	-	-	-
	Stop	-	-	B	C	C	F	C	E	E	F
	Stop	C	C	C	C	C	C	D	D	D	E
		A	A	A	A	A	A	A	A	A	C
		A	A	A	A	A	A	A	A	A	A
<b>3. Lincoln Ave. &amp; Parker Rd.</b> a. EB L (Dual) (Prot) b. EB T c. EB R (Yield) d. WB L (Dual) (Prot) e. WB T f. WB R (Free) g. NB L (Dual) (Prot) h. NB T i. NB R (Yield) j. SB L (Dual) (Prot) k. SB T l. SB R (Free) m. <b>INTERSECTION</b>	<b>Signal</b>	E	F	E	F	F	F	F	F	F	F
		D	E	D	E	C	D	D	E	C	D
		A	A	A	A	A	A	A	A	A	A
		F	F	F	F	E	F	F	F	E	F
		D	D	D	D	E	D	D	D	D	D
		A	A	A	A	A	A	A	A	A	A
		F	F	F	F	E	F	F	F	F	F
		C	D	D	D	D	D	F	F	F	F
		A	A	A	A	A	A	A	A	A	A
		E	F	E	F	E	F	E	F	F	F
		C	D	D	F	D	F	F	F	F	F
		A	A	A	A	A	A	A	A	A	A
		D	E	D	F	D	F	F	F	F	F
		D	E	D	F	D	F	F	F	F	F
<b>4. Dransfeldt Rd. &amp; Lowe's Access</b> a. EB LR b. EB LTR c. WB LT d. WB R e. NB L f. NB T g. NB TR h. SB L i. SB TR j. <b>INTERSECTION</b>	<b>TWSC</b>	B	B	B	C	-	-	C	D	-	-
	Stop	-	-	-	-	F	F	-	-	F	F
	Stop	-	-	-	-	F	F	-	-	F	F
	Stop	-	-	-	-	B	B	-	-	B	B
		A	A	A	A	A	A	A	A	A	A
		A	A	A	A	-	-	A	A	-	-
		-	-	-	-	A	A	-	-	A	A
		-	-	-	-	A	B	-	-	A	B
		A	A	A	A	A	A	A	A	A	A
		A	A	A	A	B	D	A	A	D	F
		A	A	A	A	B	D	A	A	D	F
		A	A	A	A	B	D	A	A	D	F

## B. Queue Lengths and Storage Required

Queue lengths and associated storage requirements for auxiliary lanes (turn bays) at the study area intersections were calculated for the 2020 (existing) and 2023 (buildout) and 2040 (long-range) analysis horizon background and total traffic scenarios using the results of the *Synchro* 10 95<sup>th</sup> percentile reported queue lengths. Results of the queue length/turn bay storage length requirement calculations are provided in Table 3. A narrative of the summary of the queue length/storage analysis and comparison to existing turn bay storage is provided below.

- **Lincoln Ave./Dransfeldt Rd** – Based on the results of the queuing analysis it is projected that the eastbound and southbound left turn lanes will have adequate capacity to serve the intersection through the 2040 (long-range) analysis horizon total traffic scenario. The westbound left turn lane is projected to exceed its capacity in the 2023 (buildout) analysis horizon total traffic scenario. A potential mitigation measure would be to add a second westbound left turn lane with approximately 400 feet of additional storage. This would provide enough capacity to adequately serve the westbound left turn movement through the 2040 (long-range) analysis horizon total traffic scenario. The northbound left turn and shared left turn/through lanes are projected to exceed their capacities by the 2040 (long-range) analysis horizon background traffic scenario (the traffic queues will spill back across the Dransfeldt Rd./Lowe's Access intersection). With the construction of the proposed Lincoln & Dransfeldt development and the recommended improvements described above for the Lincoln Ave./Dransfeldt Rd. and Dransfeldt Rd./Lowe's Access/Site Access intersections dual northbound left turn lanes will be constructed that will have sufficient capacity (>450 feet) to accommodate the projected 2040 (long-range) analysis horizon total traffic scenario (175 feet).
- **Lincoln Ave./Walgreens Access** – The Lincoln Ave./Walgreens Access intersections will be restricted to right turn only access and have one northbound right turn approach lane. The projected northbound right turn queues can be accommodated on the existing approach laneage.
- **Lincoln Ave./Parker Rd** - Based on the results of the queuing analysis, the eastbound, westbound, northbound and southbound left turn lanes are projected to have sufficient storage capacity through the 2040 (long-range) analysis horizon total traffic scenario.
- **Dransfeldt Rd./Lowe's Access/Site Access** – Based on the results of the queuing analysis, it is projected that the northbound left turn lane has sufficient storage capacity through the 2040 (long-range) analysis horizon total traffic scenario. The projected eastbound and westbound queues will be absorbed within their respective developments. The southbound left turn lane will be constructed concurrently with the Lincoln & Dransfeldt development and have 50 feet of storage. The 50-foot storage length is used to provide a minimum length left turn bay such that the inside northbound left turn lane proposed for the Lincoln Ave./Dransfeldt Rd. intersection can be maximized. Based on the *Synchro* 10 HCM 6 95<sup>th</sup> percentile reported queue lengths, the projected 2040 (long-range) analysis horizon PM peak hour queue is 55 feet. However, the projected 2040 (long-range) analysis horizon AM and PM peak hour southbound left turn traffic volumes are 300vph and 278vph, respectively. Based on these volumes, the CDOT State Highway Access Code and AASHTO design guidelines recommend providing a minimum of 300 feet of storage. Using the CDOT and AASHTO criteria, the proposed 50-foot storage lane would significantly exceed its capacity spilling back into the southbound through lane, essentially blocking it. In order to mitigate this, a second southbound through lane between Lincoln Ave. and the Lowe's Access is recommended.

This second southbound through lane will serve as a de facto by-pass lane such that southbound through traffic will not be impeded by the southbound left turn queues. Figure 16 provides a conceptual improvement layout for the Dransfeldt Rd./Lowes Access/Site Access and Lincoln Ave./Dransfeldt Rd. Dransfeldt Rd. intersections, as well as for Dransfeldt Rd. between Lincoln Ave. and the Lowes Access driveway.

### C. Safety Analysis

No traffic safety hazards currently exist in the vicinity of the project site and no safety hazards are anticipated to be created by the construction of the proposed Lincoln and Dransfeldt development.

**TABLE 3  
SUMMARY OF RESULTS - QUEUE LENGTHS**

INTERSECTION	EXISTING STORAGE (FT)	INTERSECTION CONTROL	2020 TRAFFIC		2023 BACKGROUND TRAFFIC		2023 TOTAL TRAFFIC		2040 BACKGROUND TRAFFIC		2040 TOTAL TRAFFIC	
			QUEUE LENGTH (FT) 95TH%		QUEUE LENGTH (FT) 95TH%		QUEUE LENGTH (FT) 95TH%		QUEUE LENGTH (FT) 95TH%		QUEUE LENGTH (FT) 95TH%	
			AM PEAK	PM PEAK	AM PEAK	PM PEAK	AM PEAK	PM PEAK	AM PEAK	PM PEAK	AM PEAK	PM PEAK
<b>1. Lincoln Ave. &amp; Dransfeldt Rd.</b>	-	<b>SIGNAL</b>	-	-	-	-	-	-	-	-	-	-
a. EB L (Prot+Perm)	200		41	79	40	93	38	60	44	143	48	100
b. EB R	-		45	54	53	62	74	94	58	105	85	137
c. WB L (Prot+Perm)	400		177	219	184	247	434	551	232	363	663	773
d. WB R	-		0	0	0	1	0	1	0	4	0	0
e. NB L (Split)	250		112	214	117	232	-	-	-	324	-	-
f.. NB LT (Split)	300		114	218	122	240	-	-	-	335	-	-
g. NB L (Dual) (Prot+Perm)	-		-	-	-	-	77	137	167	-	69	151
h. NB R (Perm)	-		49	76	58	81	-	-	-	129	-	-
i. NB R (Perm+ov)	-		-	-	-	-	48	130	72	-	0	81
j. SB L (Split)	100		11	31	11	31	-	-	-	42	-	-
k. SB L (Prot+Perm)	100		-	-	-	-	8	26	14	-	2	11
l. SBR	-		0	0	0	0	0	24	4	54	0	0
<b>2. Lincoln Ave. &amp; Walgreens Access</b>	-	<b>TWSC</b>	-	-	-	-	-	-	-	-	-	-
a. NB LR	-	Stop	8	43	-	-	-	-	-	-	-	-
b. NB R	-	Stop	-	-	3	15	80	198	5	40	145	435
c. SBR	-	Stop	10	40	10	28	13	35	25	75	30	95
<b>3. Lincoln Ave. &amp; Parker Rd.</b>	-	<b>SIGNAL</b>	-	-	-	-	-	-	-	-	-	-
a. EB L (Dual) (Prot)	700		155	309	158	315	204	466	320	564	238	490
b. WB L (Dual) (Prot)	750		152	138	162	149	113	149	235	181	163	217
c. NB L (Dual) (Prot)	1100		290	208	312	248	326	345	479	452	501	495
d. SB L (Dual) (Prot)	950		136	234	144	287	173	315	211	534	283	486
<b>4. Dransfeldt Rd. &amp; Lowe's Access</b>	-	<b>TWSC</b>	-	-	-	-	-	-	-	-	-	-
a. EB LR	-	Stop	8	15	8	18	-	-	18	48	-	-
b. EB LTR	-	Stop	-	-	-	-	65	163	-	-	143	303
c. WB LT	-	Stop	-	-	-	-	85	143	-	-	140	218
d. WB R	-	Stop	-	-	-	-	15	20	-	-	18	28
e. NB L	125		0	0	3	0	0	0	3	3	3	3
f.. SB L	-		-	-	-	-	28	38	-	-	33	55

## VII. SUMMARY

The Lincoln & Dransfeldt development is projected to generate 8,505 daily vehicle trips, of which 791 are projected to be generated during the AM peak hour and 738 are projected to be generated during the PM peak hour.

Plaza Street Partners is proposing to develop a parcel of land containing approximately 7.82 acres of mostly undeveloped land. The subject parcel is situated south of Lincoln Avenue, east of Dransfeldt Road and west of Parker Road. The property is within the jurisdictional boundaries of Parker, Colorado. The proposed Lincoln & Dransfeldt development will consist of a 5,637 sf convenience market with 12 vehicle fueling stations, 3 fast-food restaurants with drive-thru windows containing 2,050 sf, 3,750 sf and 2,000 sf, respectively, an automated carwash with a single wash tunnel, and a 1,600 sf quick lubrication vehicle shop. Based on these parameters, at buildout, the proposed development is projected to generate 8,505 daily vehicle trips of which 791 are projected to be generated during the AM peak hour and 738 are projected to be generated during the PM peak hour.

The proposed Lincoln & Dransfeldt development will have two access points. The primary access point will intersect Dransfeldt Road opposite the existing Lowes access driveway near the southwest corner of the site. The secondary access point will intersect the existing Walgreens/Lincoln Ave. access road near the northeast corner of the site. The layout of the site plan has preserved the ability for additional cross access points along the southern and eastern borders of the parcel to be implemented in the future.

Based on the analyses contained herein, Table 4 presents the summary of recommendations for the study area intersections required to accommodate the proposed Lincoln & Dransfeldt development project.

**TABLE 4  
SUMMARY OF RECOMMENDATIONS**

Intersection	Recommendations	Responsible	Timing
Lincoln Ave./ Dransfeldt Rd.	The east, west and north legs of the intersection will not require any geometric improvements. The south leg of the intersection should be widened to have dual northbound left turn lanes with a minimum total of 400 feet of storage, one through lane and one right turn lane on the northbound approach, and two southbound departure lanes. Operational improvements should include removing the split phased signal timing and implementing protected/permitted left turn phasing on the northbound and southbound approaches. Also, the northbound right turn movement should have permitted/overlap phasing in order to minimize the projected right turn queues. Figure 16 provides a conceptual layout for the recommended geometric improvements.	Developer	Concurrent with Project
Lincoln Ave./ Walgreens Access	Provide signing and pavement markings to prohibit left northbound left turns.	Developer	Concurrent with Project

**SUMMARY OF RECOMMENDATIONS (CONTINUED)**

Intersection	Recommendations	Responsible	Timing
Lincoln Ave./ Parker Rd.	No geometric or operational modifications are recommended as a result of the development of the proposed project.	N.A.	N.A.
Dransfeldt Rd./ Lowe's Access/ Site Access	The intersection will have stop sign control on the eastbound and westbound approaches. The west leg of the intersection will not require any modifications. The east leg of the intersection will have one shared left turn/through lane and one right turn lane on the westbound approach, and one eastbound departure lane. The north leg of the intersection will be constructed to have one southbound left turn lane with 50 feet of storage, one through lane and one shared through/right turn lane on the southbound approach, and two northbound departure lanes. The south leg of the intersection will have one left turn lane, one through lane and one shared through/right turn lane on the northbound approach, and two southbound departure lanes. Figure 16 provides a conceptual layout for the recommended geometric improvements.	Developer	Concurrent with Project

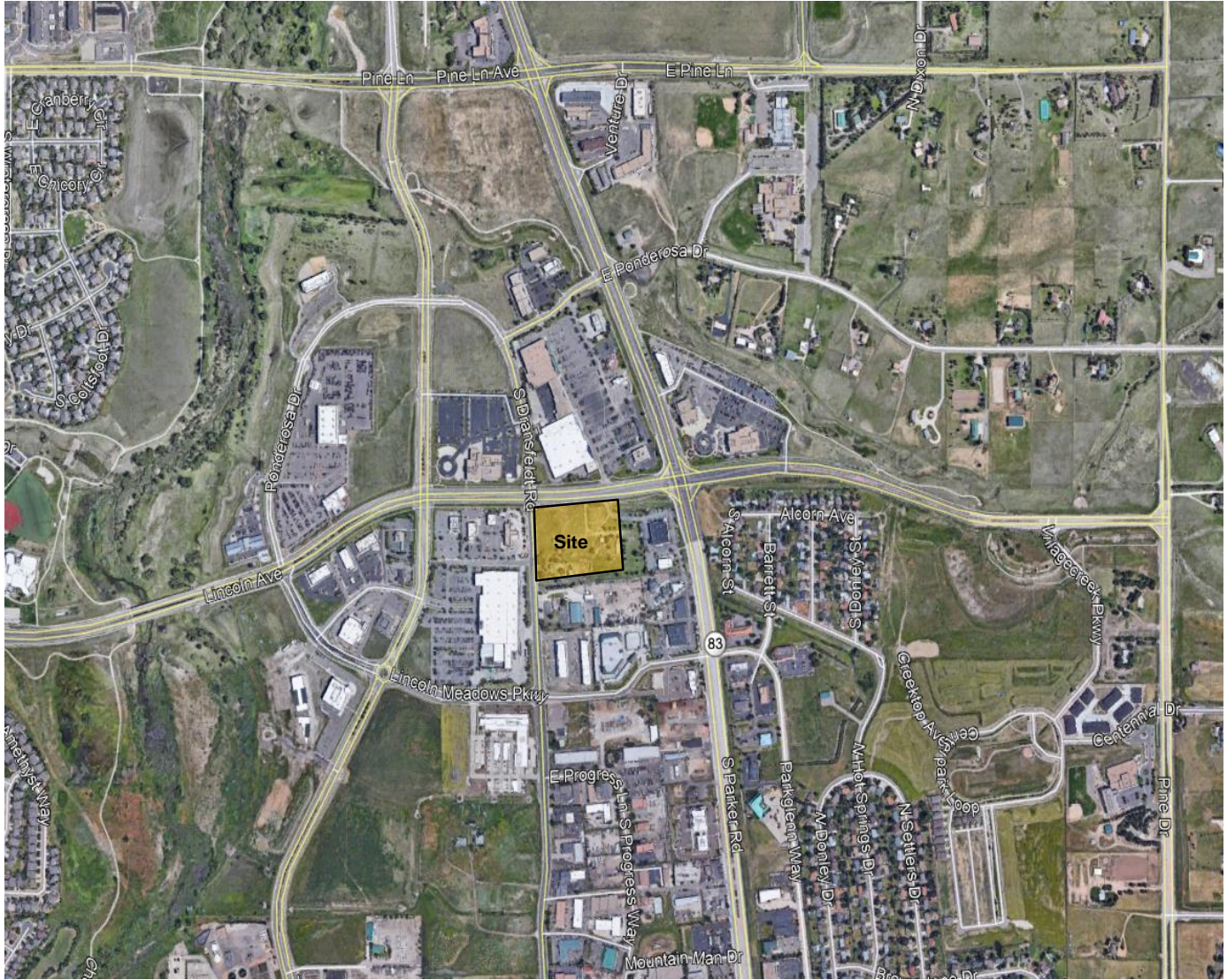

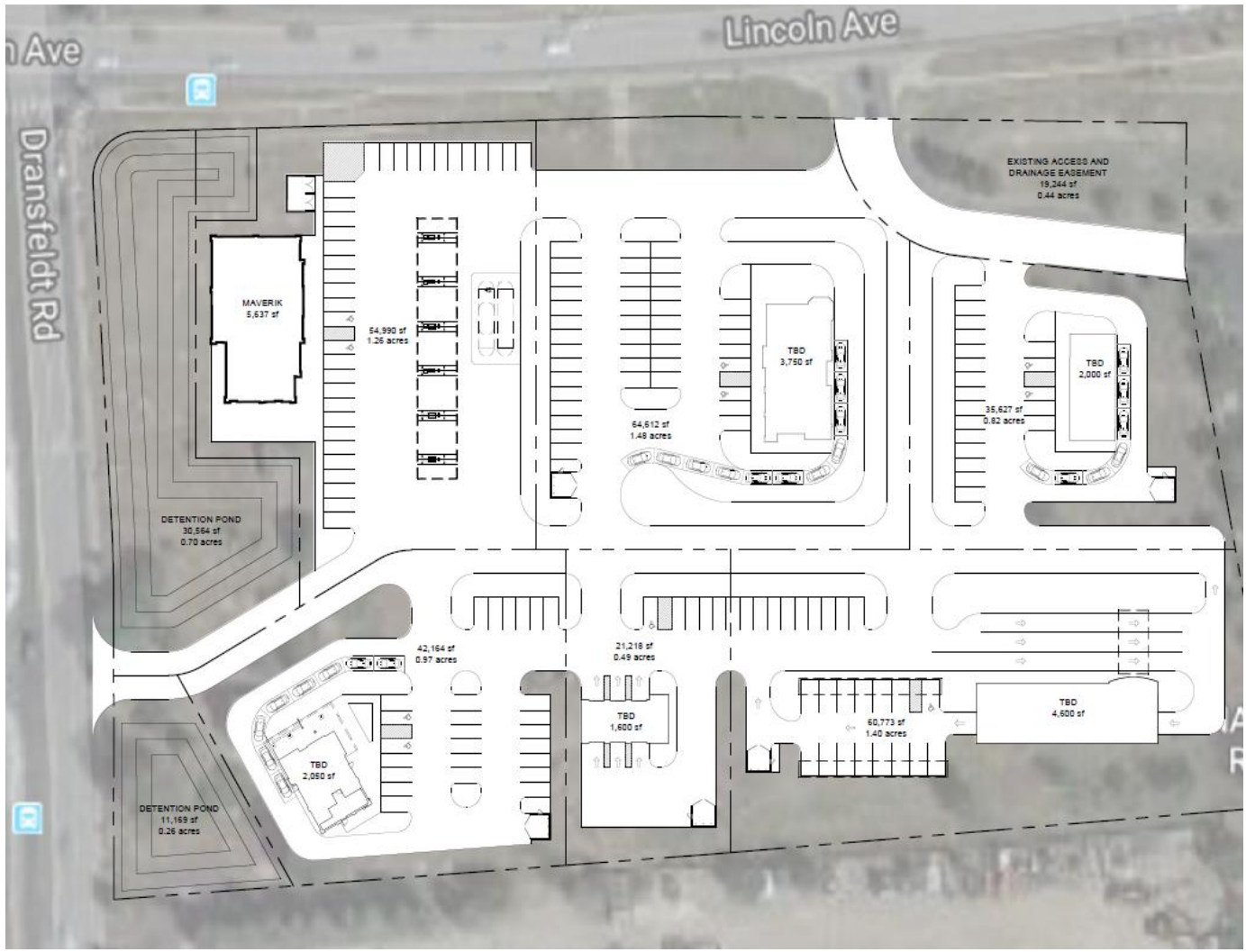

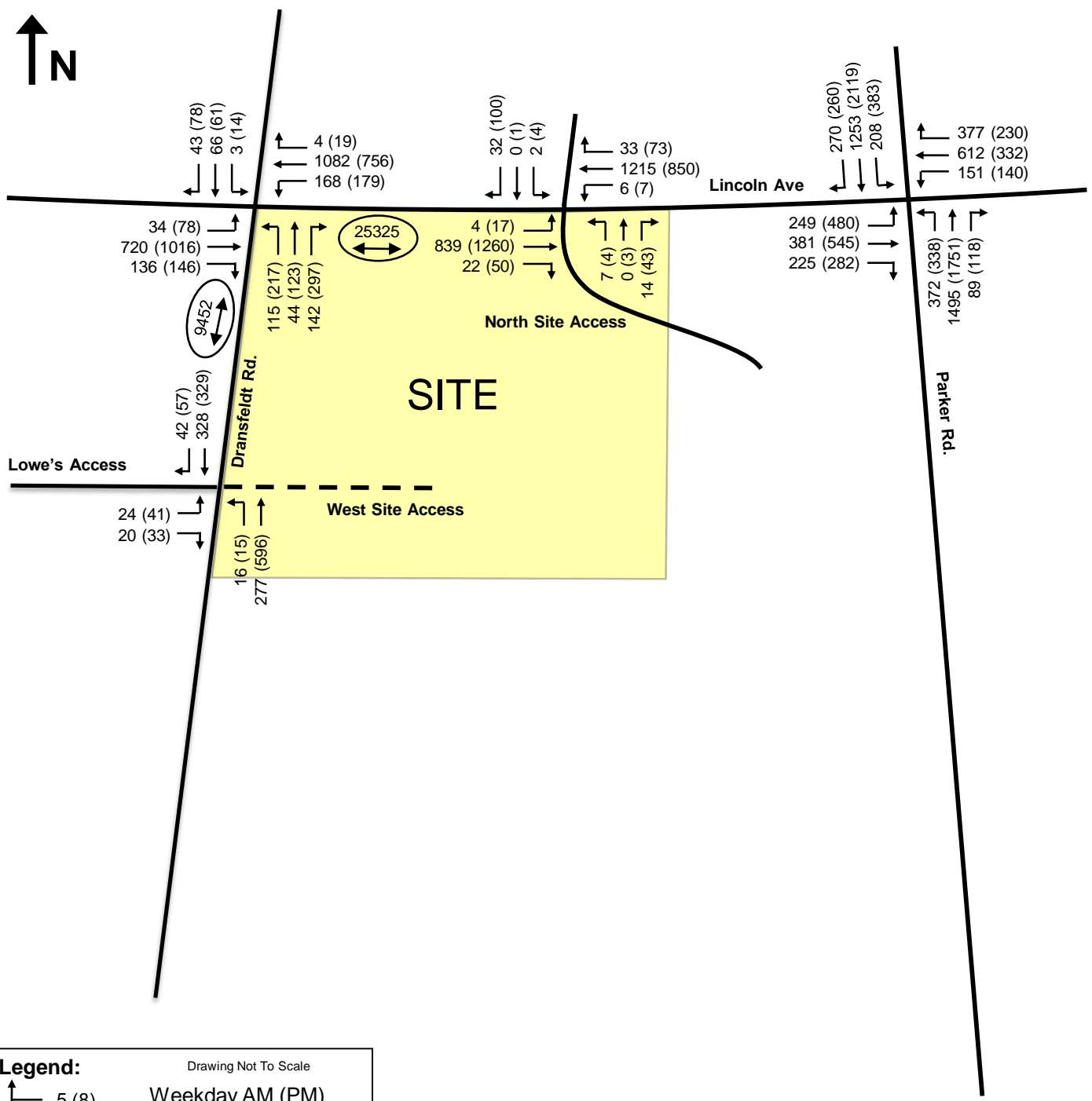

## 2020 Existing Traffic Volumes



### Lincoln & Dransfeldt

Plaza Street Partners

HKS #200829

Figure 3

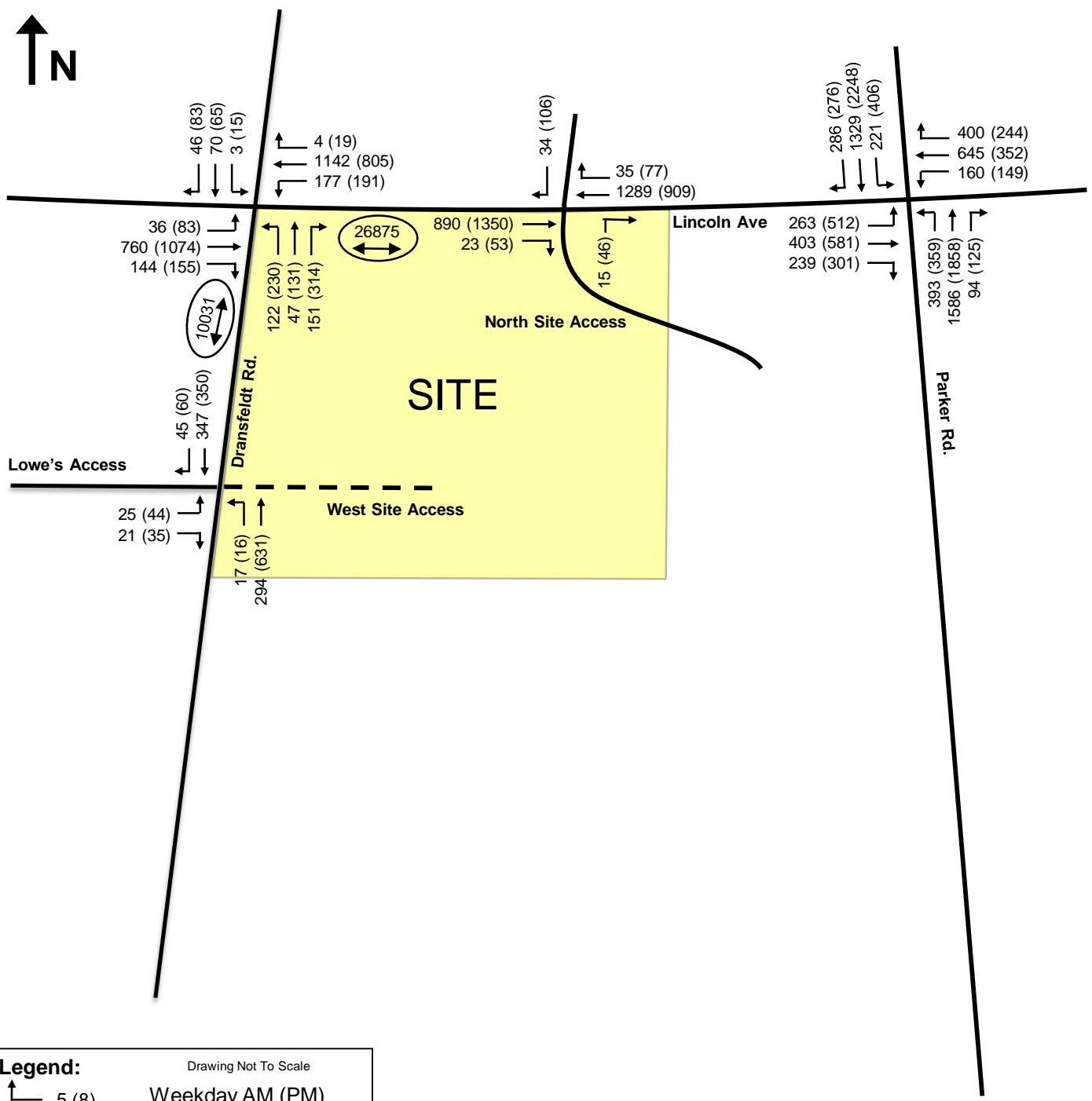

**Legend:** Drawing Not To Scale

- 5 (8) Weekday AM (PM)
- 64 (50) Peak Hour
- 8 (7) Traffic Volumes, vph
- 3199 Daily Traffic Volumes, vpd



# 2023 Background Traffic Volumes

**Lincoln & Dransfeldt**  
 Plaza Street Partners  
 HKS #200829

Figure 4

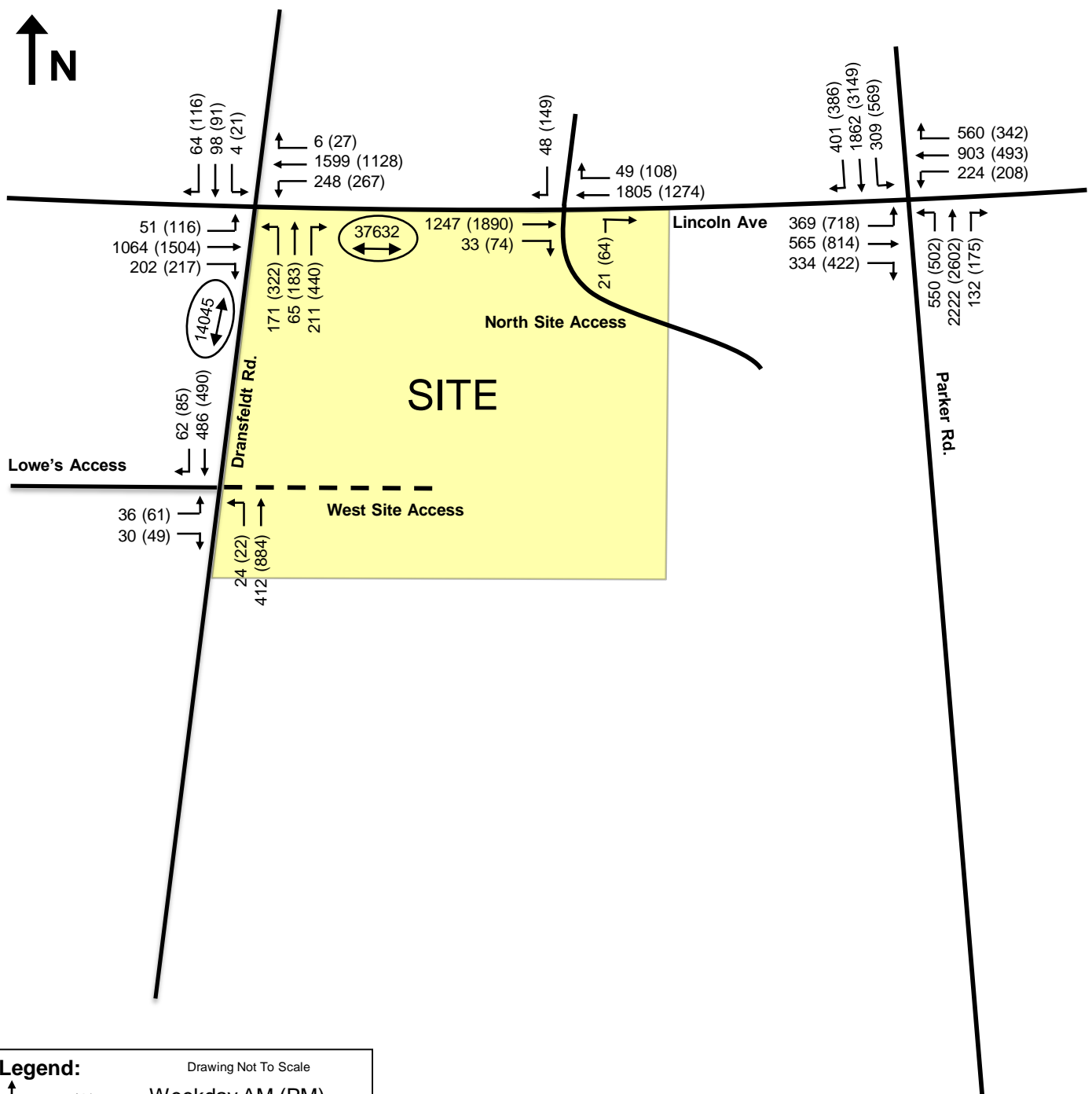

**Legend:** Drawing Not To Scale

- ↑ 5 (8) Weekday AM (PM)
- ← 64 (50) Peak Hour
- ↘ 8 (7) Traffic Volumes, vph
- ↔ (3199) Daily Traffic Volumes, vpd



# 2040 Background Traffic Volumes

**Lincoln & Dransfeldt**  
 Plaza Street Partners  
 HKS #200829

Figure 5

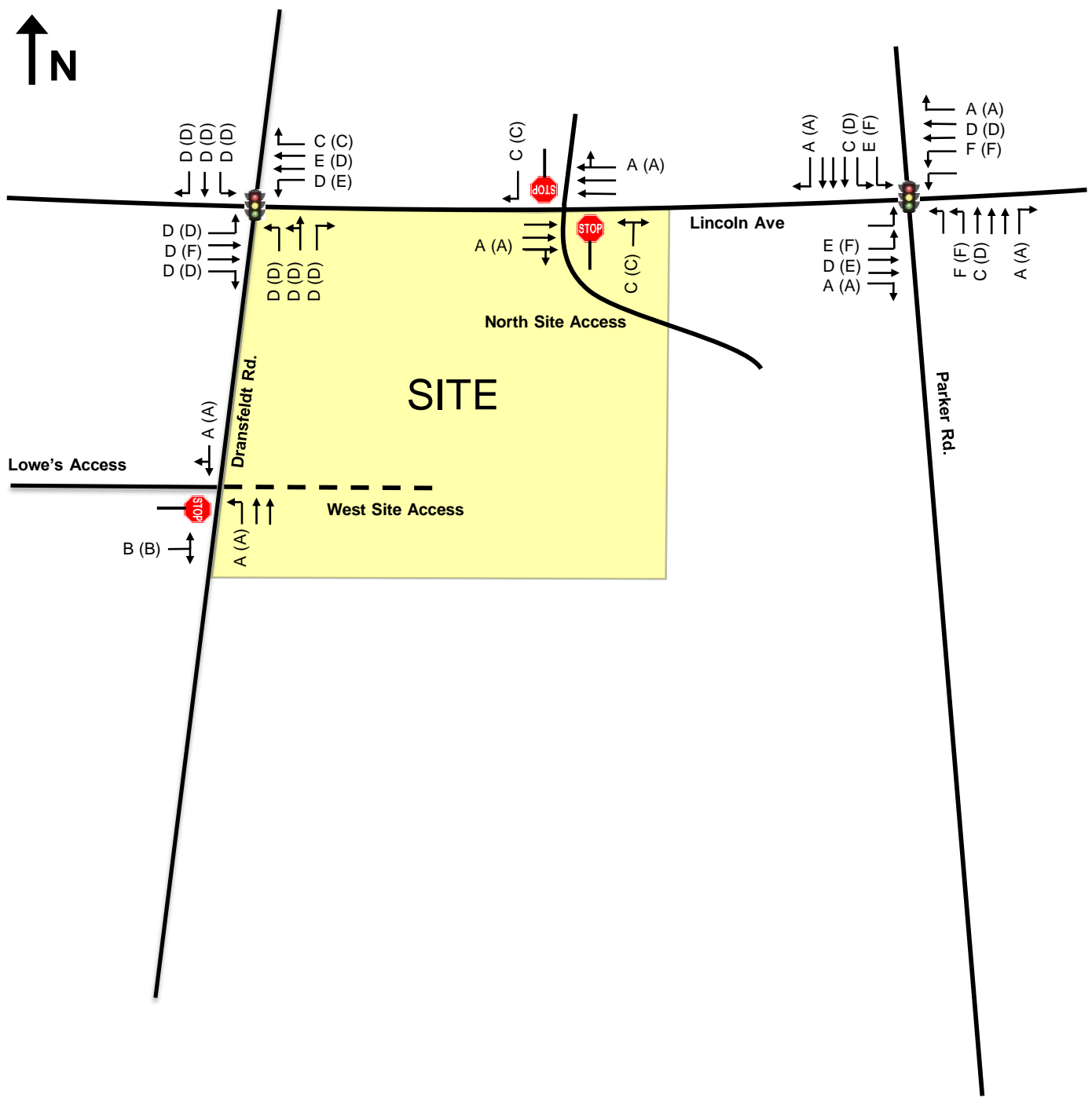

**Legend:** Drawing Not To Scale

	A (B)	Weekday AM (PM)
	B (C)	Peak Hour
	D (D)	Level of Service



# 2020 Existing Traffic Operational Conditions

**Lincoln & Dransfeldt**  
 Plaza Street Partners  
 HKS #200829

Figure 6

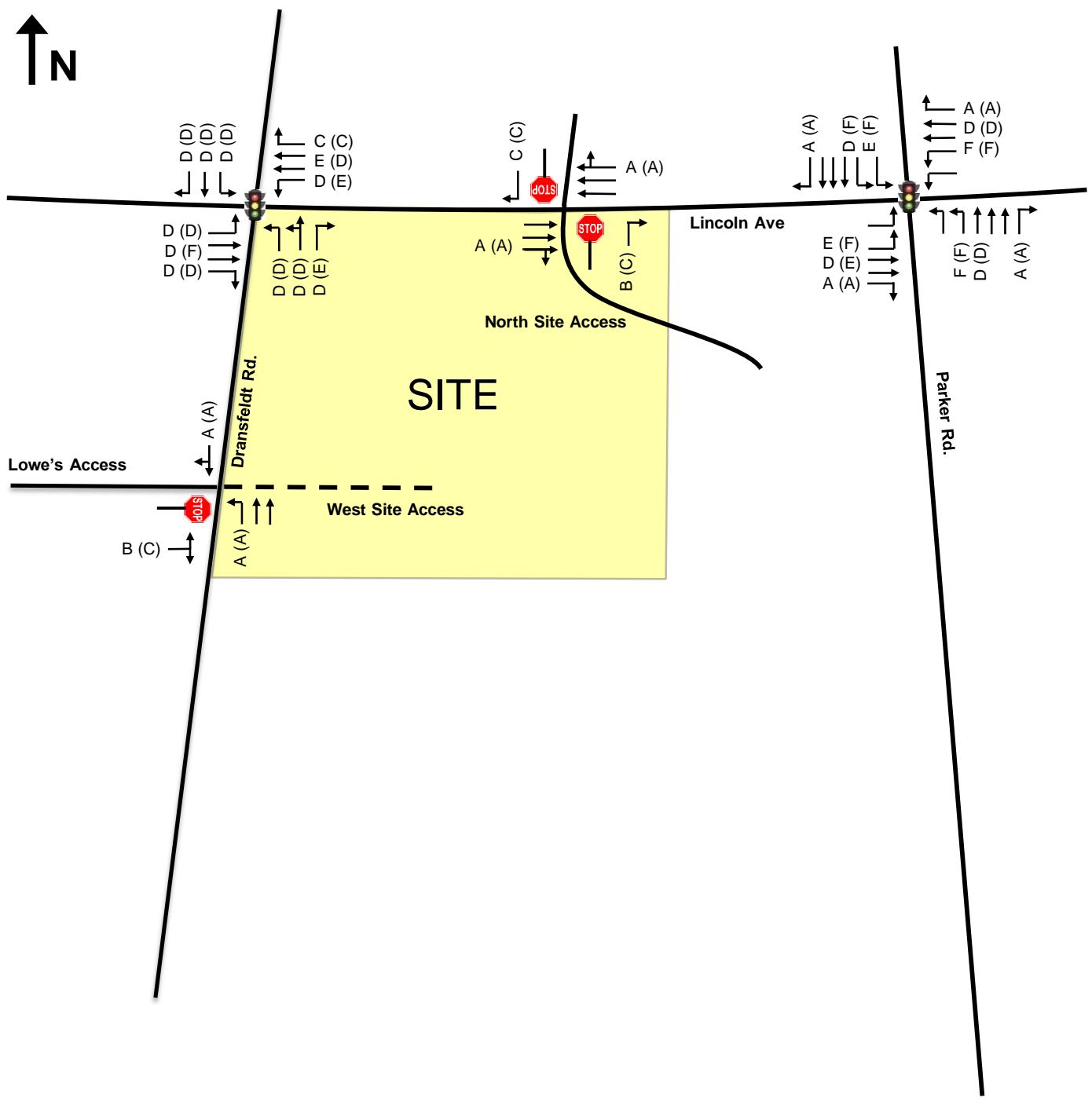

**Legend:** Drawing Not To Scale

	A (B)	Weekday AM (PM)
	B (C)	Peak Hour
	D (D)	Level of Service

# 2023 Background Traffic Operational Conditions



**Lincoln & Dransfeldt**  
 Plaza Street Partners  
 HKS #200829

Figure 7

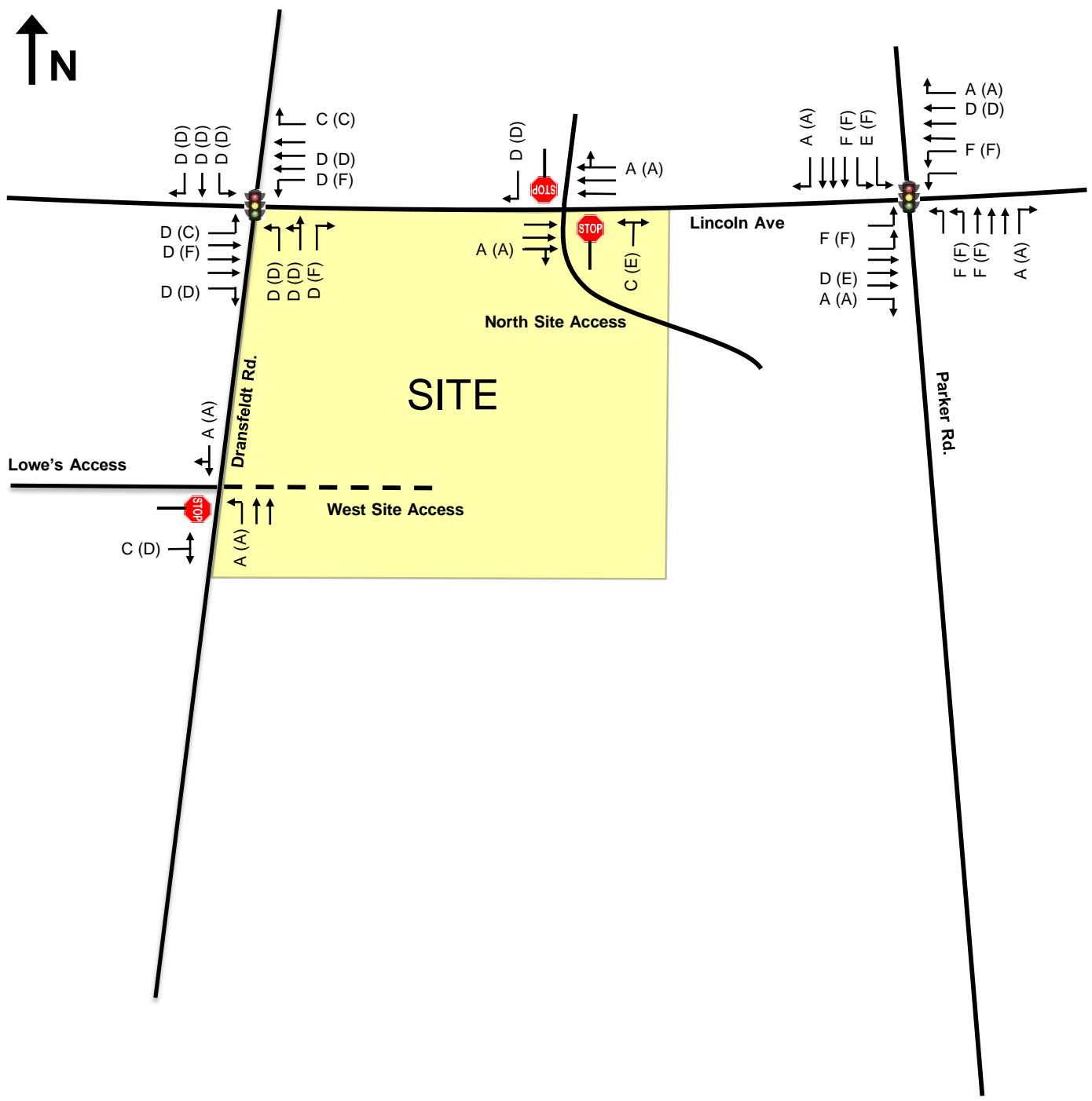

**Legend:** Drawing Not To Scale

	A (B)	Weekday AM (PM)
	B (C)	Peak Hour
	D (D)	Level of Service



# 2040 Background Traffic Operational Conditions

**Lincoln & Dransfeldt**  
 Plaza Street Partners  
 HKS #200829

Figure 8

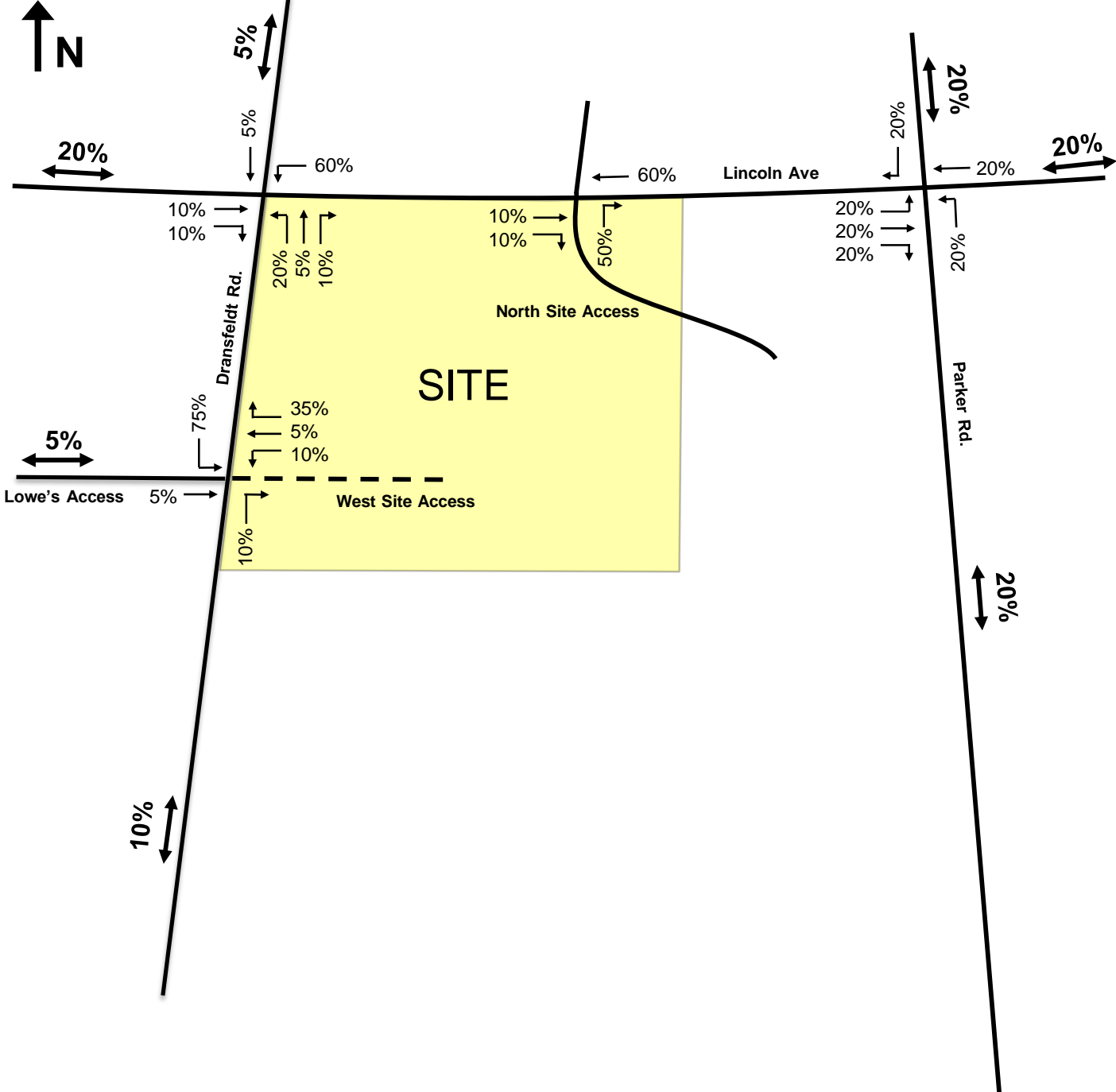

**Legend:** Drawing Not To Scale

**XX%** Site-Generated Trip Distribution



## Site-Generated Trip Distribution

**Lincoln & Dransfeldt**  
 Plaza Street Partners  
 HKS #200829

Figure 9

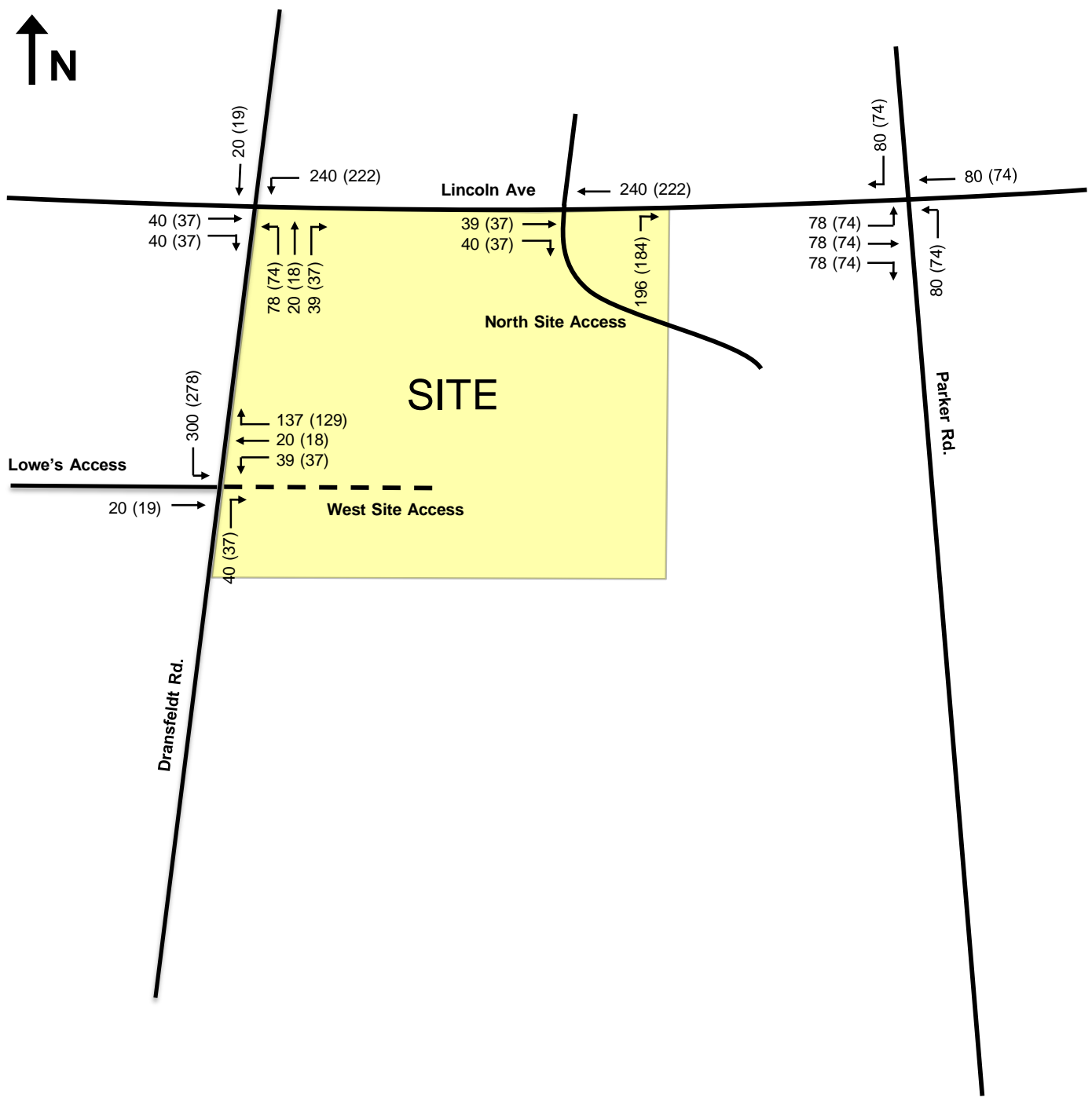

# Site-Generated Trip Assignment

**Lincoln & Dransfeldt**  
 Plaza Street Partners  
 HKS #200829

Figure 10

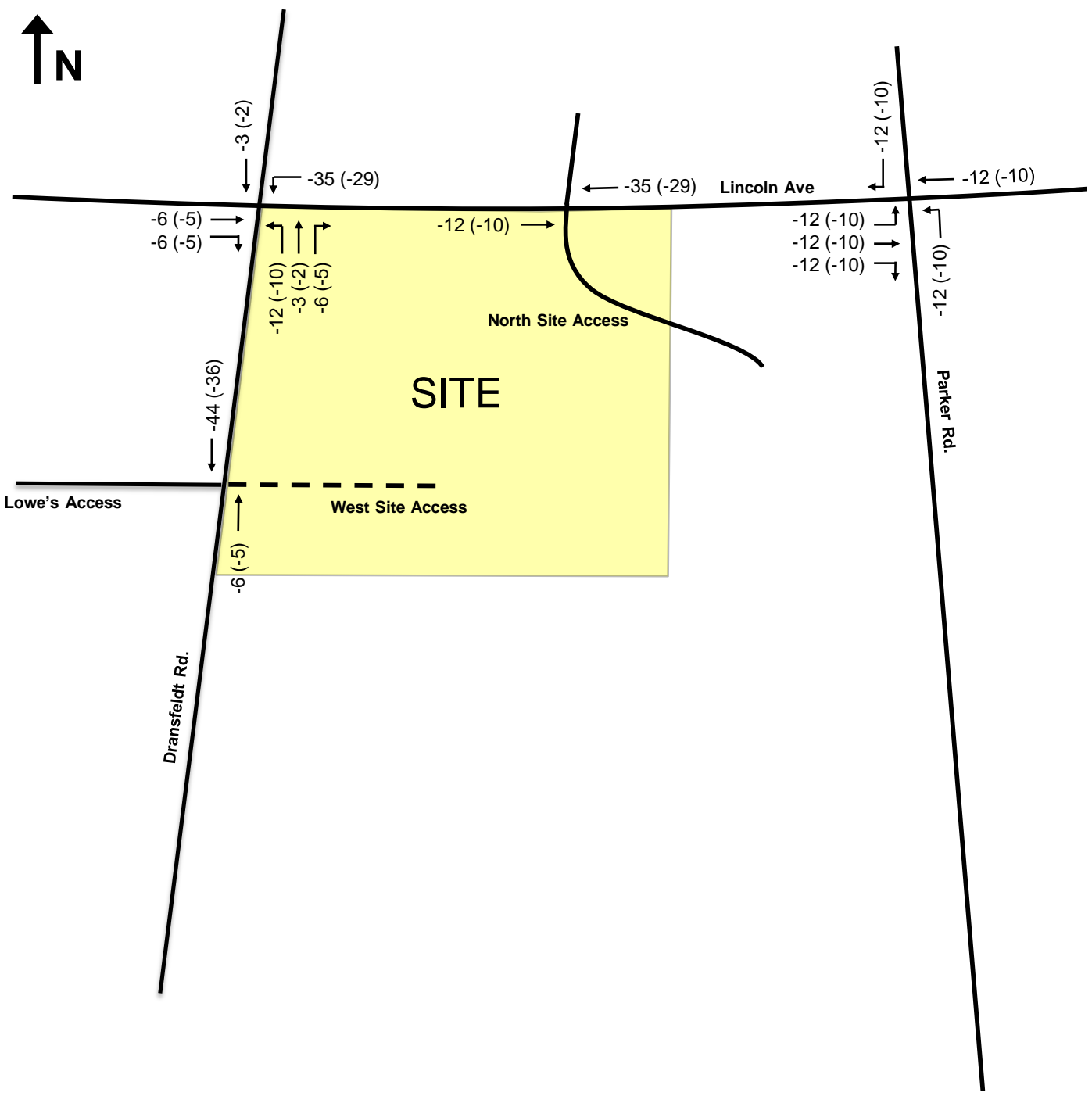

Legend:		Drawing Not To Scale
	5 (8)	Weekday AM (PM)
	64 (50)	Peak Hour
	8 (7)	Traffic Volumes, vph



# Peak Hour Pass-By Trips

**Lincoln & Dransfeldt**  
 Plaza Street Partners  
 HKS #200829

Figure 11

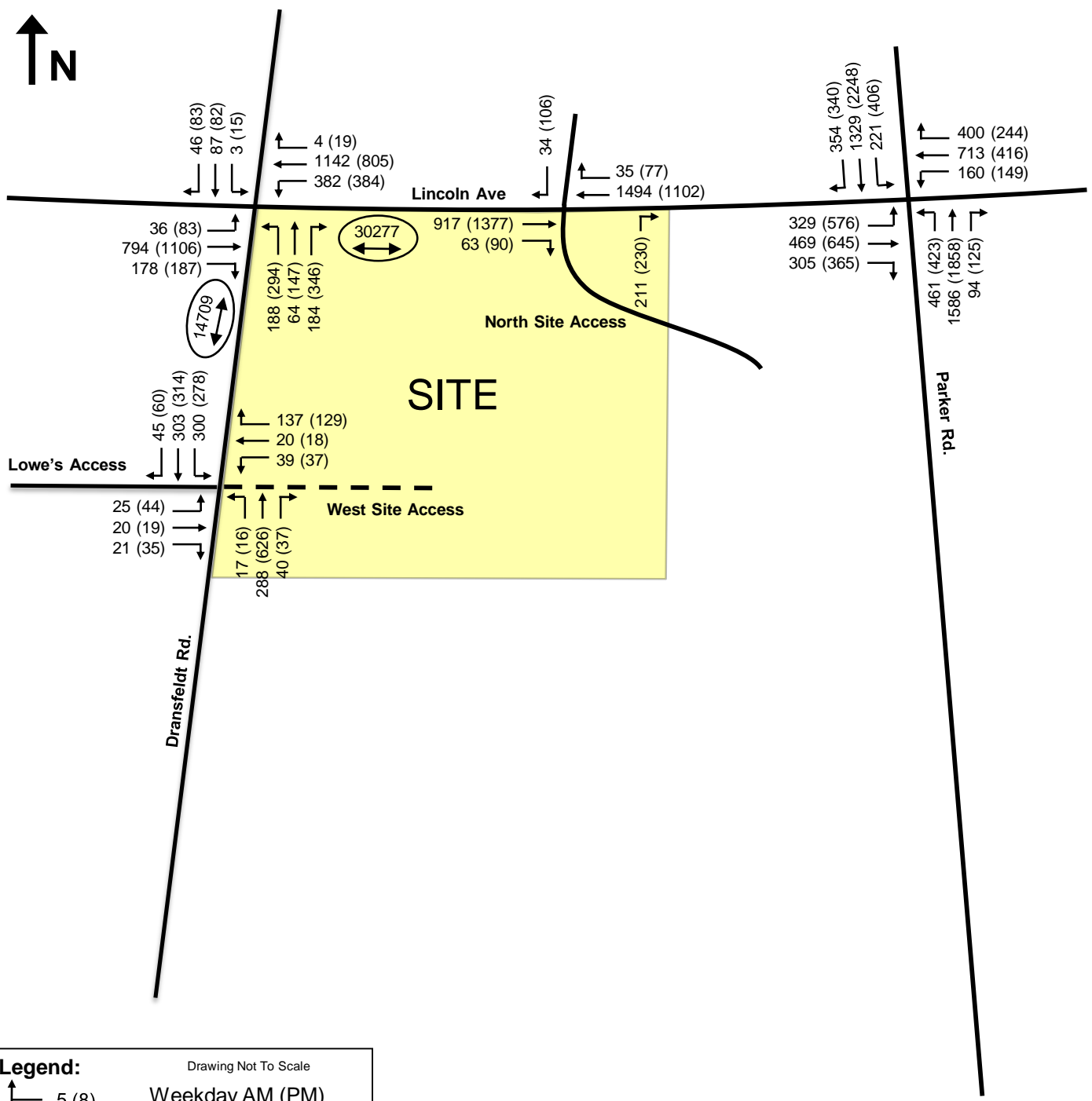

**Legend:** Drawing Not To Scale

- ↖ 5 (8) Weekday AM (PM)
- ← 64 (50) Peak Hour
- ↙ 8 (7) Traffic Volumes, vph
- ↔ (3199) Daily Traffic Volumes, vpd



# 2023 Total Traffic Volumes (Background + Site Generated)

**Lincoln & Dransfeldt**  
 Plaza Street Partners  
 HKS #200829

Figure 12

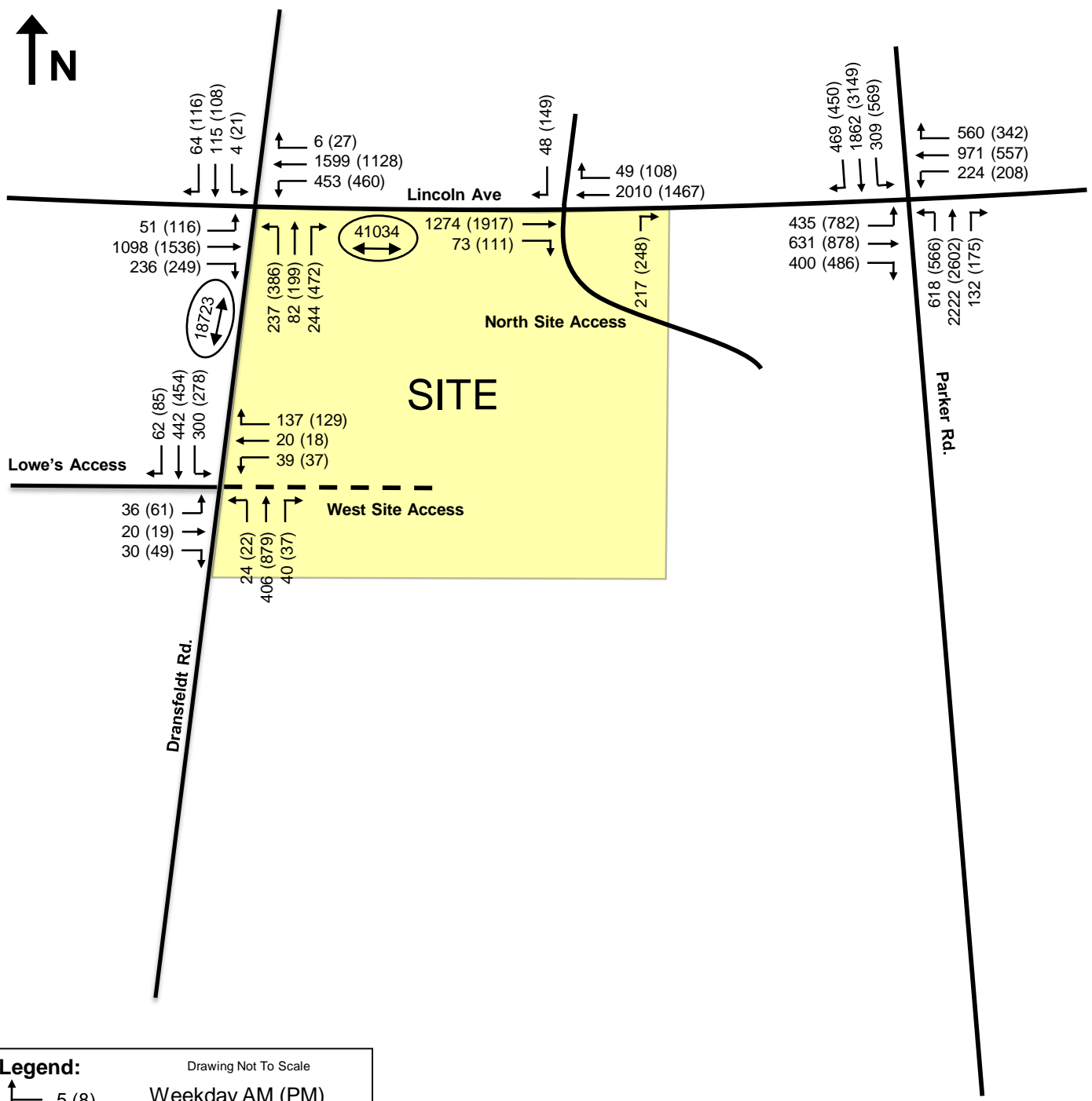

**Legend:** Drawing Not To Scale

- ↑ 5 (8) Weekday AM (PM)
- ← 64 (50) Peak Hour
- ↘ 8 (7) Traffic Volumes, vph
- ↔ (3199) Daily Traffic Volumes, vpd



## 2040 Total Traffic Volumes (Background + Site Generated)

**Lincoln & Dransfeldt**  
 Plaza Street Partners  
 HKS #200829

Figure 13

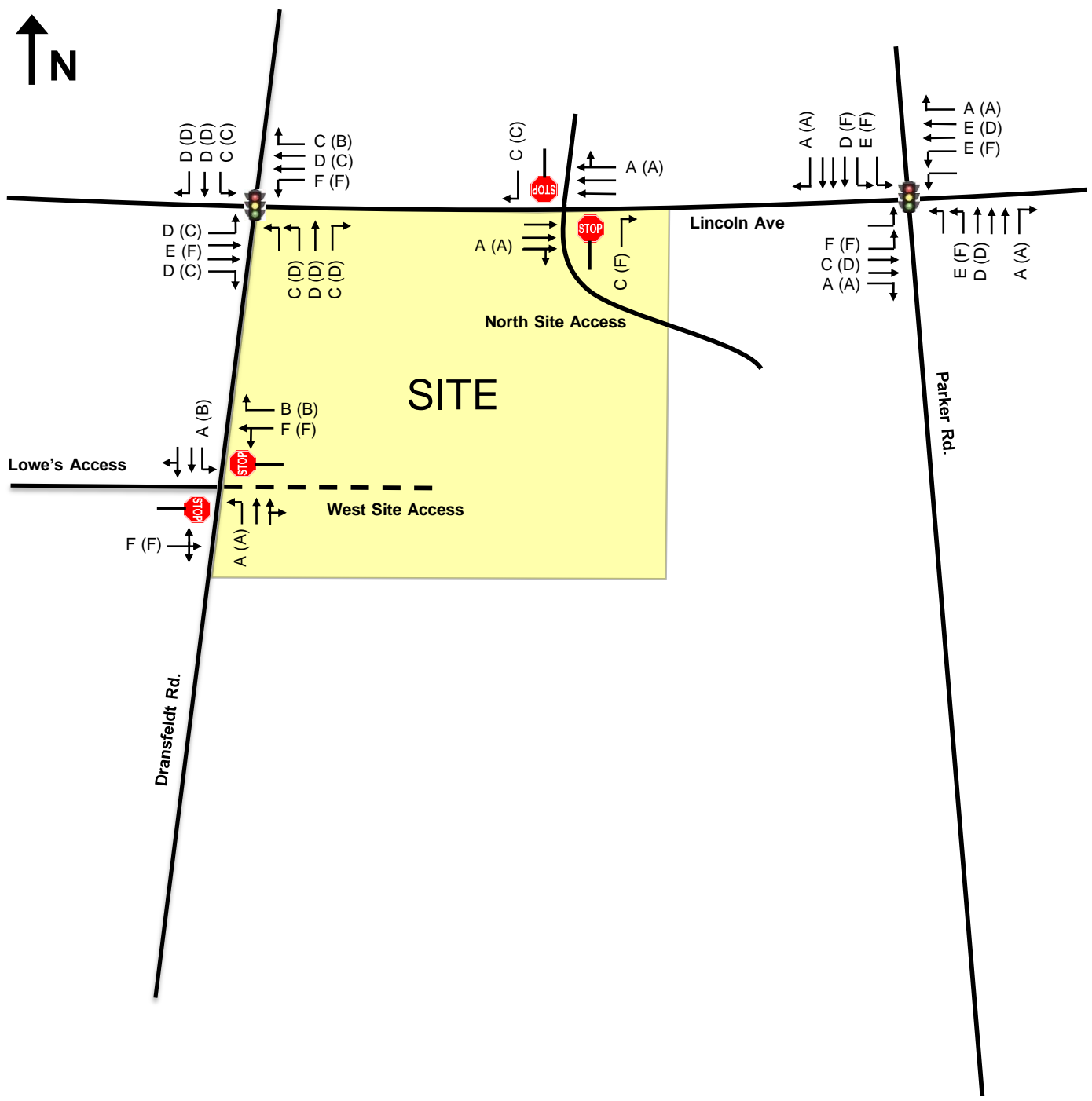

**Legend:** Drawing Not To Scale

	A (B)	Weekday AM (PM)
	B (C)	Peak Hour
	D (D)	Level of Service

## 2023 Total Traffic Operational Conditions (Background + Site Generated)

**Lincoln & Dransfeldt**  
 Plaza Street Partners  
 HKS #200829

Figure 14



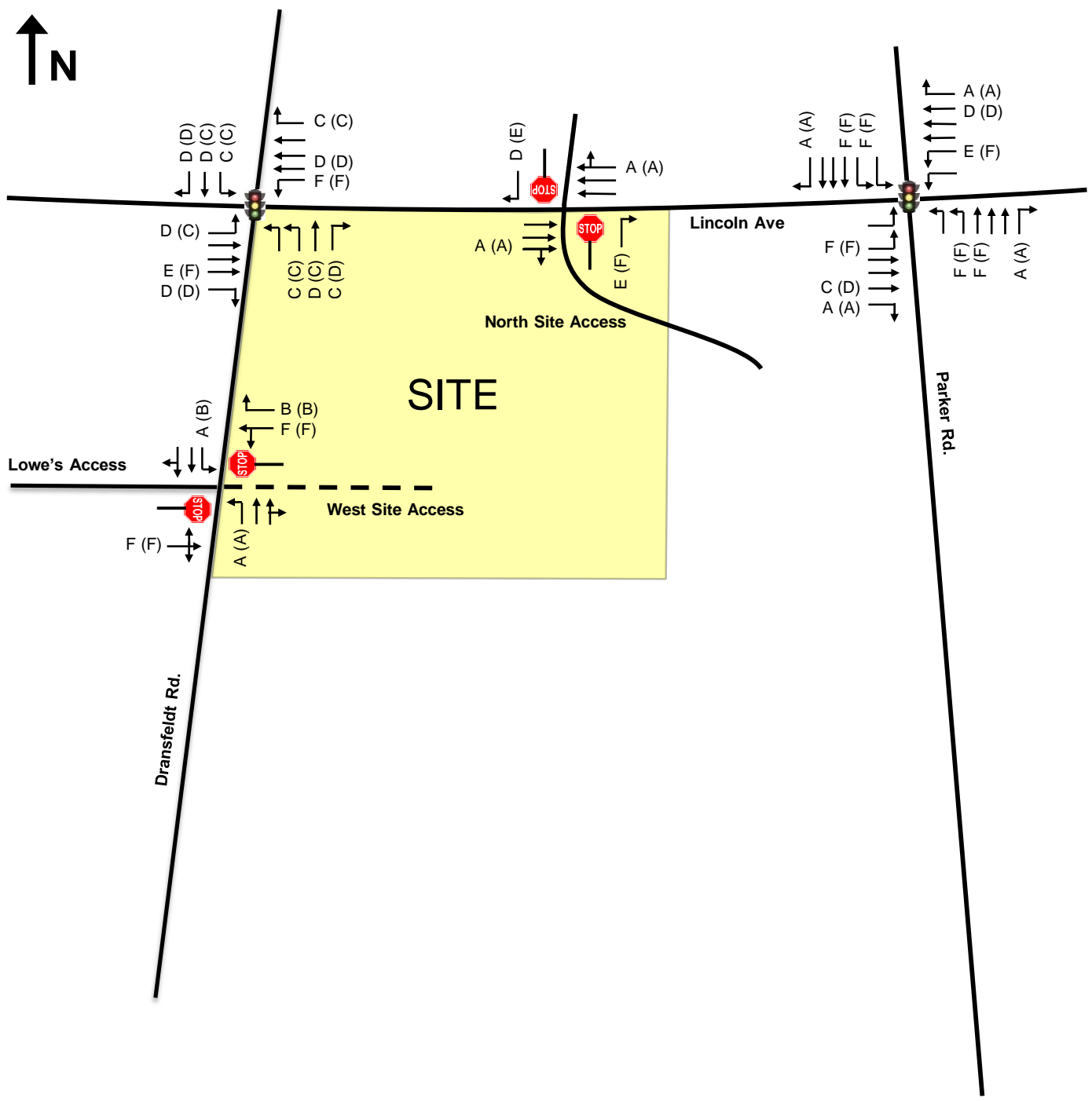

**Legend:** Drawing Not To Scale

	A (B)	Weekday AM (PM)
	B (C)	Peak Hour
	D (D)	Level of Service

## 2040 Total Traffic Operational Conditions (Background + Site Generated)



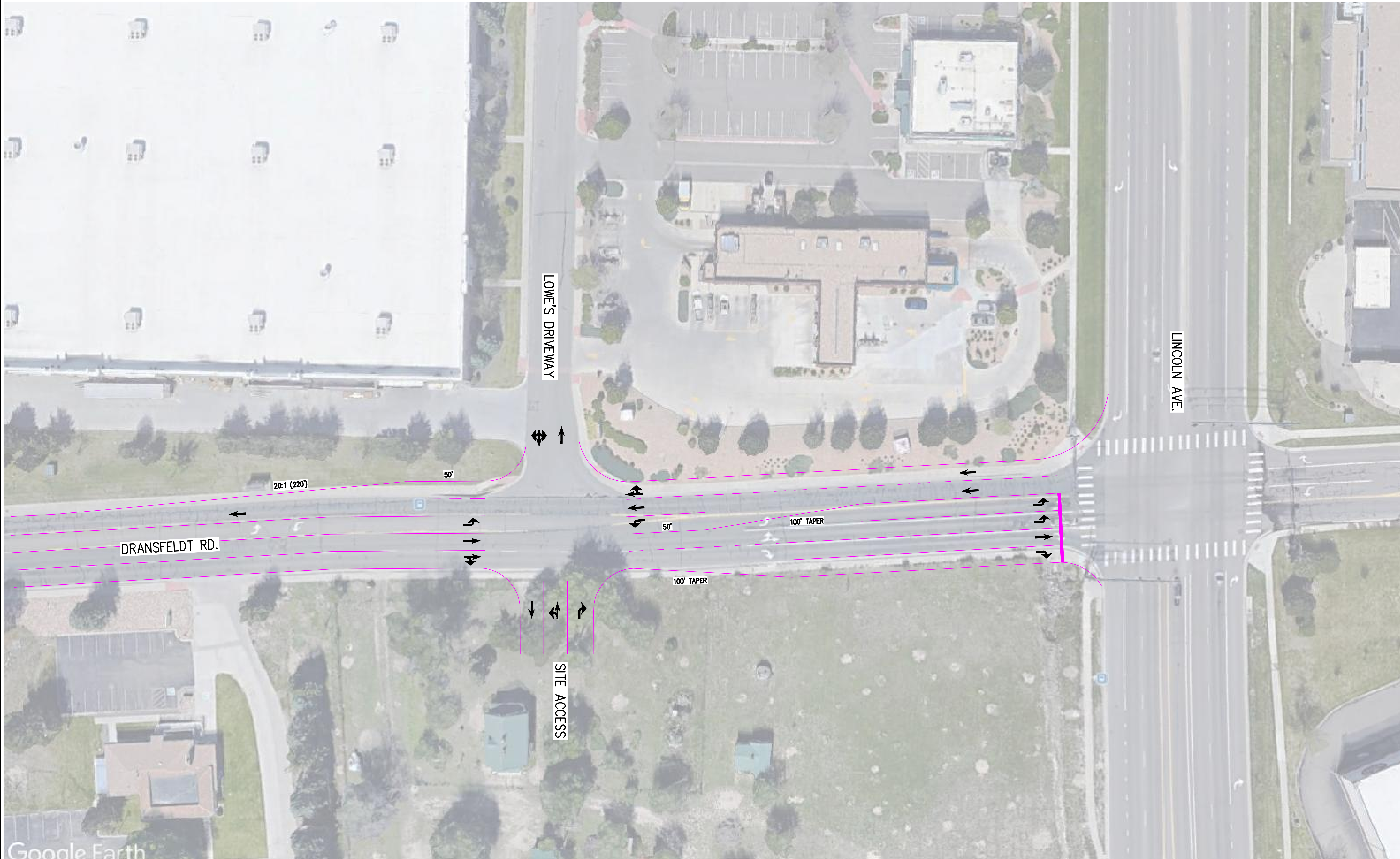

- NOTES:**
- ALL 11' LANE WIDTHS
  - POSTED SPEED = 35 MPH

FIGURE 16: DRANSFELDT ROAD CONCEPTUAL IMPROVEMENT LAYOUT

SCALE: 1" = 30'

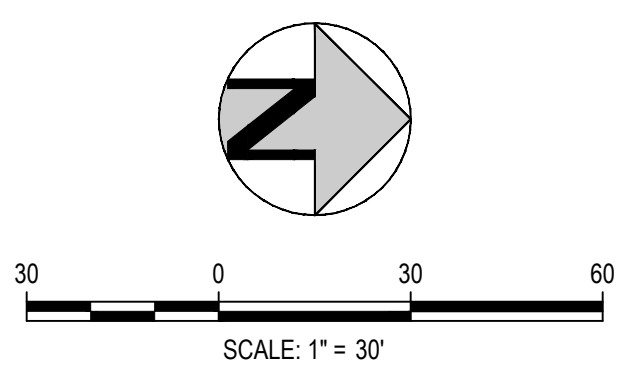

---

**APPENDIX “A”**

**2020 EXISTING  
TRAFFIC VOLUME COUNTS**

---







(303) 216-2439  
www.alltrafficdata.net

Location: 1 DRANSFELDT RD & LINCOLN AVE AM

Date: Thursday, September 3, 2020

Peak Hour: 07:15 AM - 08:15 AM

Peak 15-Minutes: 07:45 AM - 08:00 AM

**Peak Hour - All Vehicles**

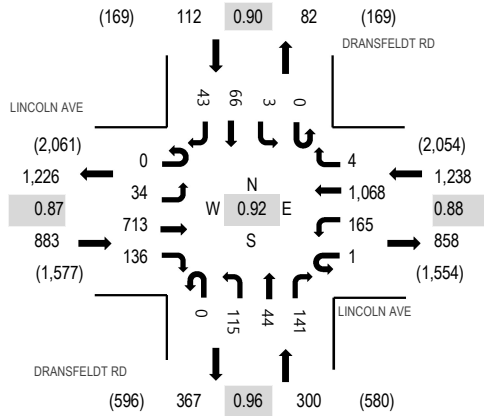

Note: Total study counts contained in parentheses.

**Peak Hour - Pedestrians/Bicycles on Crosswalk**

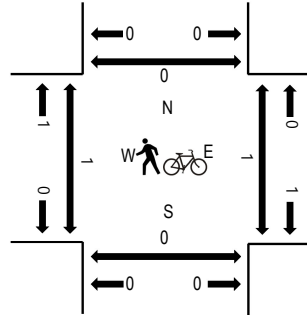

**Traffic Counts**

Interval Start Time	LINCOLN AVE Eastbound				LINCOLN AVE Westbound				DRANSFELDT RD Northbound				DRANSFELDT RD Southbound				Total	Rolling Hour	Pedestrian Crossings			
	U-Turn	Left	Thru	Right	U-Turn	Left	Thru	Right	U-Turn	Left	Thru	Right	U-Turn	Left	Thru	Right			West	East	South	North
7:00 AM	0	8	122	13	0	33	192	1	0	15	4	14	0	1	8	5	416	2,343	0	0	0	0
7:15 AM	0	5	155	21	0	25	262	1	0	35	13	37	0	1	12	18	585	2,533	0	0	0	0
7:30 AM	0	8	211	40	0	51	252	2	0	23	9	31	0	0	20	10	657	2,447	0	0	0	0
7:45 AM	0	13	171	42	1	56	294	1	0	30	13	38	0	1	18	7	685	2,267	0	0	0	0
8:00 AM	0	8	176	33	0	33	260	0	0	27	9	35	0	1	16	8	606	2,037	1	0	0	0
8:15 AM	0	9	162	26	0	27	179	0	0	34	16	33	0	1	7	5	499		0	0	0	0
8:30 AM	0	10	168	18	0	29	156	3	0	38	12	33	0	0	5	5	477		0	0	0	0
8:45 AM	0	9	128	21	0	29	165	2	0	35	13	33	0	1	13	6	455		0	0	0	0
Count Total	0	70	1,293	214	1	283	1,760	10	0	237	89	254	0	6	99	64	4,380		1	0	0	0
Peak Hour	0	34	713	136	1	165	1,068	4	0	115	44	141	0	3	66	43	2,533		1	0	0	0



(303) 216-2439  
www.alltrafficdata.net

Location: 2 PARKER RD & LINCOLN AVE AM  
Date: Thursday, September 3, 2020  
Peak Hour: 07:15 AM - 08:15 AM  
Peak 15-Minutes: 07:45 AM - 08:00 AM

### Peak Hour - All Vehicles

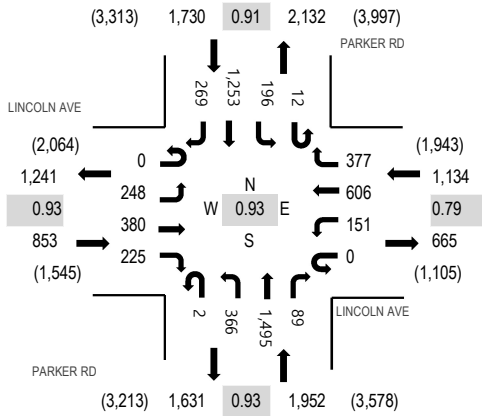

Note: Total study counts contained in parentheses.

### Peak Hour - Pedestrians/Bicycles on Crosswalk

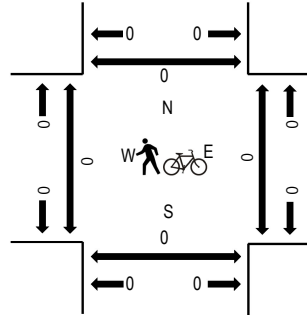

### Traffic Counts

Interval Start Time	LINCOLN AVE Eastbound				LINCOLN AVE Westbound				PARKER RD Northbound				PARKER RD Southbound				Total	Rolling Hour	Pedestrian Crossings			
	U-Turn	Left	Thru	Right	U-Turn	Left	Thru	Right	U-Turn	Left	Thru	Right	U-Turn	Left	Thru	Right			West	East	South	North
7:00 AM	0	48	47	25	0	20	114	69	0	62	383	13	2	26	275	49	1,133	5,443	0	1	0	0
7:15 AM	0	69	97	39	0	37	153	100	0	69	379	12	4	35	257	64	1,315	5,669	0	0	0	0
7:30 AM	0	57	117	47	0	32	144	91	0	97	400	27	2	54	331	68	1,467	5,558	0	0	0	0
7:45 AM	0	65	102	63	0	53	198	108	1	113	358	33	2	59	303	70	1,528	5,349	0	0	0	0
8:00 AM	0	57	64	76	0	29	111	78	1	87	358	17	4	48	362	67	1,359	4,936	0	0	0	0
8:15 AM	0	60	80	63	0	51	98	66	1	63	325	14	3	43	290	47	1,204		1	0	0	0
8:30 AM	0	81	54	59	0	35	85	76	1	60	358	14	1	45	344	45	1,258		0	0	0	0
8:45 AM	0	72	50	53	0	52	97	46	0	49	270	13	5	41	313	54	1,115		0	0	0	0
Count Total	0	509	611	425	0	309	1,000	634	4	600	2,831	143	23	351	2,475	464	10,379		1	1	0	0
Peak Hour	0	248	380	225	0	151	606	377	2	366	1,495	89	12	196	1,253	269	5,669		0	0	0	0



(303) 216-2439  
www.alltrafficdata.net

Location: 3 DRANSFELDT RD & LOWES ACCESS AM

Date: Thursday, September 3, 2020

Peak Hour: 07:30 AM - 08:30 AM

Peak 15-Minutes: 07:45 AM - 08:00 AM

Peak Hour - All Vehicles

Peak Hour - Pedestrians/Bicycles on Crosswalk

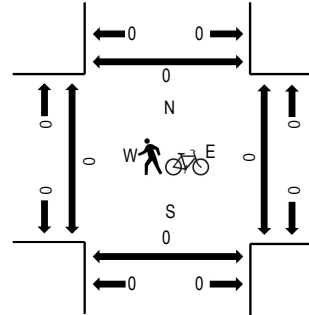
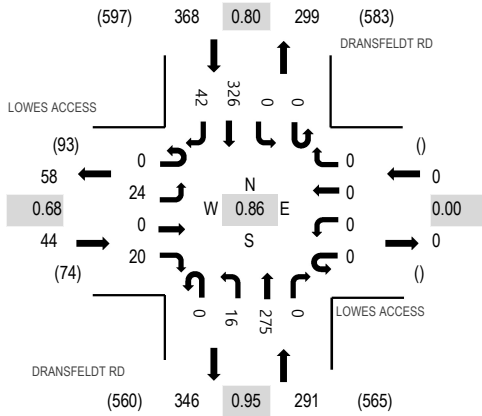

Note: Total study counts contained in parentheses.

Traffic Counts

Interval Start Time	LOWES ACCESS Eastbound				LOWES ACCESS Westbound				DRANSFELDT RD Northbound				DRANSFELDT RD Southbound				Total	Rolling Hour	Pedestrian Crossings				
	U-Turn	Left	Thru	Right	U-Turn	Left	Thru	Right	U-Turn	Left	Thru	Right	U-Turn	Left	Thru	Right			West	East	South	North	
7:00 AM	0	1	0	2	0	0	0	0	0	1	40	0	0	0	0	45	8	97	623	0	0	0	0
7:15 AM	0	7	0	2	0	0	0	0	0	1	71	0	0	0	0	53	7	141	694	0	0	0	0
7:30 AM	0	1	0	4	0	0	0	0	0	5	63	0	0	0	0	93	15	181	703	0	0	0	0
7:45 AM	0	10	0	7	0	0	0	0	0	2	70	0	0	0	0	100	15	204	663	0	0	0	0
8:00 AM	0	8	0	7	0	0	0	0	0	5	65	0	0	0	0	77	6	168	613	0	0	0	0
8:15 AM	0	5	0	2	0	0	0	0	0	4	77	0	0	0	0	56	6	150		0	0	0	0
8:30 AM	0	3	0	3	0	0	0	0	0	1	81	0	0	0	0	48	5	141		0	0	0	0
8:45 AM	0	6	0	6	0	0	0	0	0	4	75	0	0	0	0	55	8	154		0	0	0	0
Count Total	0	41	0	33	0	0	0	0	0	23	542	0	0	0	0	527	70	1,236		0	0	0	0
Peak Hour	0	24	0	20	0	0	0	0	0	16	275	0	0	0	0	326	42	703		0	0	0	0



(303) 216-2439  
www.alltrafficdata.net

Location: 4 WALGREENS ACCESS & LINCOLN AVE AM

Date: Thursday, September 3, 2020

Peak Hour: 07:15 AM - 08:15 AM

Peak 15-Minutes: 07:45 AM - 08:00 AM

Peak Hour - All Vehicles

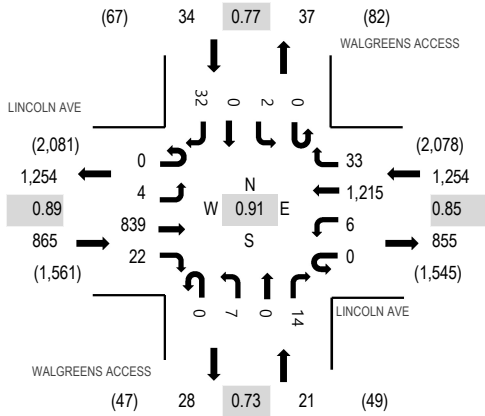

Peak Hour - Pedestrians/Bicycles on Crosswalk

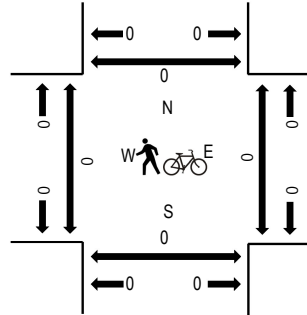

Note: Total study counts contained in parentheses.

Traffic Counts

Interval Start Time	LINCOLN AVE Eastbound				LINCOLN AVE Westbound				WALGREENS ACCESS Northbound				WALGREENS ACCESS Southbound				Total	Rolling Hour	Pedestrian Crossings			
	U-Turn	Left	Thru	Right	U-Turn	Left	Thru	Right	U-Turn	Left	Thru	Right	U-Turn	Left	Thru	Right			West	East	South	North
7:00 AM	0	0	135	3	0	0	225	6	0	3	0	2	0	0	0	2	376	2,028	0	0	0	0
7:15 AM	0	1	190	2	0	1	281	7	0	0	0	0	0	0	0	10	492	2,174	0	0	0	0
7:30 AM	0	1	237	5	0	1	303	7	0	1	0	2	0	0	0	3	560	2,090	0	0	0	0
7:45 AM	0	1	205	9	0	2	359	9	0	6	0	0	0	1	0	8	600	1,944	0	0	0	0
8:00 AM	0	1	207	6	0	2	272	10	0	0	0	12	0	1	0	11	522	1,727	0	0	0	0
8:15 AM	0	1	179	7	0	1	200	5	0	0	1	6	0	1	0	7	408		0	0	0	0
8:30 AM	0	3	201	6	0	0	172	16	0	2	0	5	0	0	0	9	414		0	0	0	0
8:45 AM	0	4	155	2	0	0	190	9	0	3	0	6	0	0	0	14	383		0	0	0	0
Count Total	0	12	1,509	40	0	7	2,002	69	0	15	1	33	0	3	0	64	3,755		0	0	0	0
Peak Hour	0	4	839	22	0	6	1,215	33	0	7	0	14	0	2	0	32	2,174		0	0	0	0



(303) 216-2439  
www.alltrafficdata.net

Location: 1 DRANSFELDT RD & LINCOLN AVE PM

Date: Thursday, September 3, 2020

Peak Hour: 04:30 PM - 05:30 PM

Peak 15-Minutes: 05:00 PM - 05:15 PM

**Peak Hour - All Vehicles**

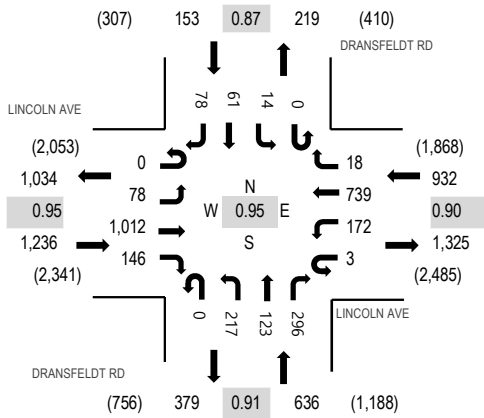

Note: Total study counts contained in parentheses.

**Peak Hour - Pedestrians/Bicycles on Crosswalk**

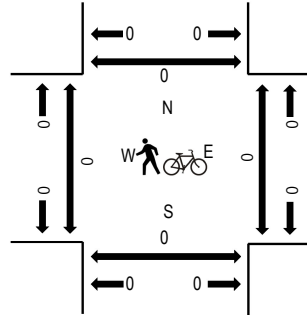

**Traffic Counts**

Interval Start Time	LINCOLN AVE Eastbound				LINCOLN AVE Westbound				DRANSFELDT RD Northbound				DRANSFELDT RD Southbound				Total	Rolling Hour	Pedestrian Crossings			
	U-Turn	Left	Thru	Right	U-Turn	Left	Thru	Right	U-Turn	Left	Thru	Right	U-Turn	Left	Thru	Right			West	East	South	North
4:00 PM	0	25	236	30	1	58	195	4	0	59	23	70	0	5	25	16	747	2,863	0	1	1	1
4:15 PM	0	23	208	33	0	44	179	4	0	50	30	67	0	2	22	12	674	2,897	0	0	0	0
4:30 PM	0	23	239	33	0	36	194	3	0	47	28	78	0	1	20	18	720	2,957	0	0	0	0
4:45 PM	0	20	264	42	1	39	179	4	0	53	28	66	0	2	9	15	722	2,933	0	0	0	0
5:00 PM	0	24	243	31	2	49	205	6	0	53	38	84	0	5	20	21	781	2,841	0	0	0	0
5:15 PM	0	11	266	40	0	48	161	5	0	64	29	68	0	6	12	24	734		0	0	0	0
5:30 PM	0	20	223	36	0	34	212	3	0	47	24	59	0	4	15	19	696		0	0	0	0
5:45 PM	1	14	223	33	1	32	167	2	0	44	19	60	0	1	15	18	630		0	0	0	0
Count Total	1	160	1,902	278	5	340	1,492	31	0	417	219	552	0	26	138	143	5,704		0	1	1	1
Peak Hour	0	78	1,012	146	3	172	739	18	0	217	123	296	0	14	61	78	2,957		0	0	0	0



(303) 216-2439  
www.alltrafficdata.net

Location: 2 PARKER RD & LINCOLN AVE PM

Date: Thursday, September 3, 2020

Peak Hour: 04:45 PM - 05:45 PM

Peak 15-Minutes: 05:15 PM - 05:30 PM

**Peak Hour - All Vehicles**

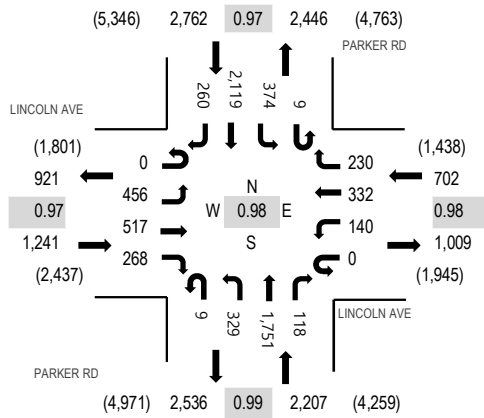

Note: Total study counts contained in parentheses.

**Peak Hour - Pedestrians/Bicycles on Crosswalk**

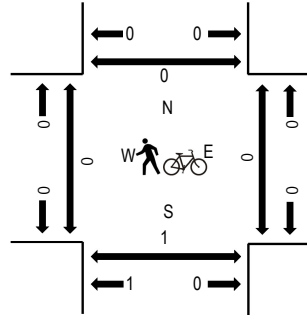

**Traffic Counts**

Interval Start Time	LINCOLN AVE Eastbound				LINCOLN AVE Westbound				PARKER RD Northbound				PARKER RD Southbound				Total	Rolling Hour	Pedestrian Crossings			
	U-Turn	Left	Thru	Right	U-Turn	Left	Thru	Right	U-Turn	Left	Thru	Right	U-Turn	Left	Thru	Right			West	East	South	North
4:00 PM	0	108	132	65	0	38	103	53	3	59	408	30	3	71	493	79	1,645	6,673	0	0	1	0
4:15 PM	0	101	117	65	0	56	79	56	1	58	435	34	2	73	489	80	1,646	6,755	0	0	2	0
4:30 PM	0	111	120	94	0	41	82	61	1	73	394	24	1	96	502	61	1,661	6,873	0	0	1	0
4:45 PM	0	107	121	76	0	48	81	62	3	84	435	25	0	88	536	55	1,721	6,912	0	0	0	0
5:00 PM	0	123	140	67	0	31	83	52	1	91	422	34	5	86	516	76	1,727	6,807	0	0	1	0
5:15 PM	0	118	138	67	0	26	84	60	2	68	465	25	3	111	537	60	1,764		0	0	0	0
5:30 PM	0	108	118	58	0	35	84	56	3	86	429	34	1	89	530	69	1,700		0	0	0	0
5:45 PM	0	92	114	77	0	35	81	51	2	60	440	30	1	95	473	65	1,616		0	0	0	0
Count Total	0	868	1,000	569	0	310	677	451	16	579	3,428	236	16	709	4,076	545	13,480		0	0	5	0
Peak Hour	0	456	517	268	0	140	332	230	9	329	1,751	118	9	374	2,119	260	6,912		0	0	1	0



(303) 216-2439  
www.alltrafficdata.net

Location: 3 DRANSFELDT RD & LOWES ACCESS PM

Date: Thursday, September 3, 2020

Peak Hour: 04:30 PM - 05:30 PM

Peak 15-Minutes: 05:00 PM - 05:15 PM

Peak Hour - All Vehicles

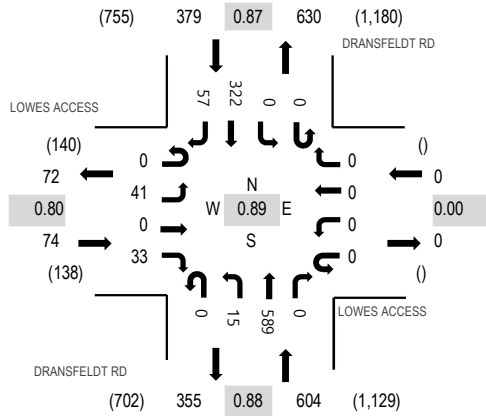

Peak Hour - Pedestrians/Bicycles on Crosswalk

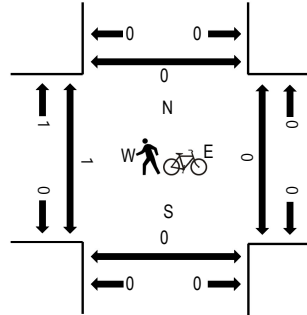

Note: Total study counts contained in parentheses.

Traffic Counts

Interval Start Time	LOWES ACCESS Eastbound				LOWES ACCESS Westbound				DRANSFELDT RD Northbound			DRANSFELDT RD Southbound				Total	Rolling Hour	Pedestrian Crossings				
	U-Turn	Left	Thru	Right	U-Turn	Left	Thru	Right	U-Turn	Left	Thru	Right	U-Turn	Left	Thru			Right	West	East	South	North
4:00 PM	0	9	0	5	0	0	0	0	0	2	144	0	0	0	93	18	271	1,023	0	0	0	0
4:15 PM	0	8	0	8	0	0	0	0	0	5	135	0	0	0	93	7	256	1,048	0	0	0	0
4:30 PM	0	15	0	8	0	0	0	0	0	3	133	0	0	0	70	16	245	1,057	0	0	0	0
4:45 PM	0	8	0	5	0	0	0	0	0	5	143	0	0	0	76	14	251	1,036	0	0	0	0
5:00 PM	0	8	0	14	0	0	0	0	0	5	167	0	0	0	87	15	296	999	0	0	0	0
5:15 PM	0	10	0	6	0	0	0	0	0	2	146	0	0	0	89	12	265		0	0	0	0
5:30 PM	0	13	0	5	0	0	0	0	0	4	119	0	0	0	65	18	224		0	0	0	0
5:45 PM	0	10	0	6	0	0	0	0	0	4	112	0	0	0	72	10	214		0	0	0	0
Count Total	0	81	0	57	0	0	0	0	0	30	1,099	0	0	0	645	110	2,022		0	0	0	0
Peak Hour	0	41	0	33	0	0	0	0	0	15	589	0	0	0	322	57	1,057		0	0	0	0



(303) 216-2439  
www.alltrafficdata.net

Location: 4 WALGREENS ACCESS & LINCOLN AVE PM

Date: Thursday, September 3, 2020

Peak Hour: 04:30 PM - 05:30 PM

Peak 15-Minutes: 05:00 PM - 05:15 PM

**Peak Hour - All Vehicles**

**Peak Hour - Pedestrians/Bicycles on Crosswalk**

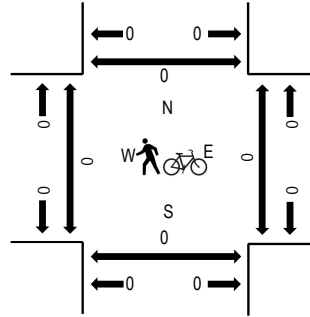
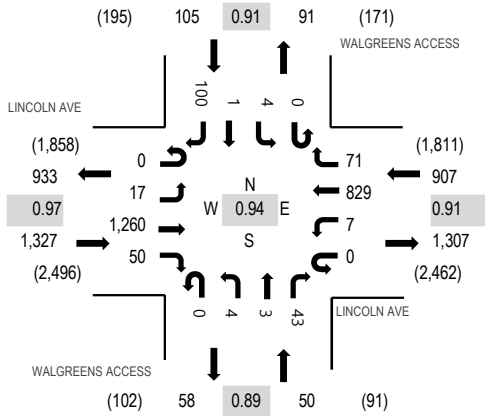

Note: Total study counts contained in parentheses.

**Traffic Counts**

Interval Start Time	LINCOLN AVE Eastbound				LINCOLN AVE Westbound				WALGREENS ACCESS Northbound				WALGREENS ACCESS Southbound				Total	Rolling Hour	Pedestrian Crossings			
	U-Turn	Left	Thru	Right	U-Turn	Left	Thru	Right	U-Turn	Left	Thru	Right	U-Turn	Left	Thru	Right			West	East	South	North
4:00 PM	0	2	298	15	0	1	219	12	0	0	2	10	0	1	0	28	588	2,283	0	0	1	0
4:15 PM	0	4	269	9	0	1	210	10	0	3	0	6	0	2	0	19	533	2,331	0	0	0	0
4:30 PM	0	5	304	10	0	1	200	18	0	1	1	9	0	2	0	26	577	2,389	0	0	0	0
4:45 PM	0	5	311	12	0	3	202	17	0	0	2	12	0	0	0	21	585	2,377	0	0	0	0
5:00 PM	0	5	319	15	0	3	239	14	0	1	0	11	0	0	0	29	636	2,310	0	0	0	0
5:15 PM	0	2	326	13	0	0	188	22	0	2	0	11	0	2	1	24	591		0	0	0	0
5:30 PM	0	5	274	7	0	0	224	22	0	1	0	9	0	1	0	22	565		0	0	0	0
5:45 PM	0	2	274	10	0	1	184	20	0	0	1	9	0	2	0	15	518		0	0	0	0
Count Total	0	30	2,375	91	0	10	1,666	135	0	8	6	77	0	10	1	184	4,593		0	0	1	0
Peak Hour	0	17	1,260	50	0	7	829	71	0	4	3	43	0	4	1	100	2,389		0	0	0	0

---

**APPENDIX “B”**

**INTERSECTION  
CAPACITY ANALYSIS  
WORKSHEETS**

---

Lanes and Geometrics  
1: Dransfeldt Rd & Lincoln Ave

Lincoln & Dransfeldt  
09/27/2020

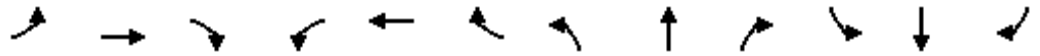

Lane Group	EBL	EBT	EBR	WBL	WBT	WBR	NBL	NBT	NBR	SBL	SBT	SBR
Lane Configurations												
Ideal Flow (vphpl)	1900	1900	1900	1900	1900	1900	1900	1900	1900	1900	1900	1900
Lane Width (ft)	12	12	12	12	12	12	12	12	12	12	12	12
Grade (%)		0%			0%			0%			0%	
Storage Length (ft)	200		0	330		0	300		0	100		0
Storage Lanes	1		1	1		1	1		1	1		1
Taper Length (ft)	25			25			25			25		
Lane Util. Factor	1.00	0.95	1.00	1.00	0.95	1.00	0.95	0.95	1.00	1.00	1.00	1.00
Ped Bike Factor			0.850			0.850			0.850			0.850
Flt Protected	0.950			0.950			0.950	0.978		0.950		
Satd. Flow (prot)	1770	3539	1583	1770	3539	1583	1681	1731	1583	1770	1863	1583
Flt Permitted	0.114			0.120			0.950	0.978		0.950		
Satd. Flow (perm)	212	3539	1583	224	3539	1583	1681	1731	1583	1770	1863	1583
Right Turn on Red			Yes			Yes			Yes			Yes
Satd. Flow (RTOR)			159			117			164			164
Link Speed (mph)		30			30			30				30
Link Distance (ft)		427			552			422				289
Travel Time (s)		9.7			12.5			9.6				6.6

Intersection Summary

Area Type: Other

Timings  
1: Dransfeldt Rd & Lincoln Ave

Lane Group	EBL	EBT	EBR	WBL	WBT	WBR	NBL	NBT	NBR	SBL	SBT	SBR
Lane Configurations												
Traffic Volume (vph)	34	720	136	168	1082	4	115	44	142	3	66	43
Future Volume (vph)	34	720	136	168	1082	4	115	44	142	3	66	43
Turn Type	pm+pt	NA	Perm	pm+pt	NA	Perm	Split	NA	Perm	Split	NA	Perm
Protected Phases	7	4		3	8		2	2		6	6	
Permitted Phases	4		4	8		8			2			6
Detector Phase	7	4	4	3	8	8	2	2	2	6	6	6
Switch Phase												
Minimum Initial (s)	3.0	10.0	10.0	4.0	10.0	10.0	5.0	5.0	5.0	5.0	5.0	5.0
Minimum Split (s)	10.0	40.0	40.0	9.5	35.0	35.0	35.0	35.0	35.0	35.0	35.0	35.0
Total Split (s)	10.0	40.0	40.0	20.0	50.0	50.0	35.0	35.0	35.0	35.0	35.0	35.0
Total Split (%)	7.7%	30.8%	30.8%	15.4%	38.5%	38.5%	26.9%	26.9%	26.9%	26.9%	26.9%	26.9%
Yellow Time (s)	4.0	4.0	4.0	3.0	3.0	3.0	3.5	3.5	3.5	3.5	3.5	3.5
All-Red Time (s)	2.0	2.0	2.0	2.0	2.0	2.0	2.0	2.0	2.0	2.0	2.0	2.0
Lost Time Adjust (s)	0.0	0.0	0.0	0.0	0.0	0.0	0.0	0.0	0.0	0.0	0.0	0.0
Total Lost Time (s)	6.0	6.0	6.0	5.0	5.0	5.0	5.5	5.5	5.5	5.5	5.5	5.5
Lead/Lag	Lead	Lag	Lag	Lead	Lag	Lag						
Lead-Lag Optimize?	Yes	Yes	Yes	Yes	Yes	Yes						
Recall Mode	None	None	None	None	None	None	C-Max	C-Max	C-Max	Max	Max	Max
Act Effct Green (s)	37.8	33.8	33.8	53.1	45.1	45.1	31.4	31.4	31.4	29.5	29.5	29.5
Actuated g/C Ratio	0.29	0.26	0.26	0.41	0.35	0.35	0.24	0.24	0.24	0.23	0.23	0.23
v/c Ratio	0.34	0.85	0.28	0.73	0.96	0.01	0.21	0.21	0.30	0.01	0.17	0.10
Control Delay	32.5	55.8	6.0	64.6	50.9	0.0	42.3	42.2	6.7	39.0	41.8	0.4
Queue Delay	0.0	0.0	0.0	0.0	0.0	0.0	0.0	0.0	0.0	0.0	0.0	0.0
Total Delay	32.5	55.8	6.0	64.6	50.9	0.0	42.3	42.2	6.7	39.0	41.8	0.4
LOS	C	E	A	E	D	A	D	D	A	D	D	A
Approach Delay		47.3			52.6			25.5			25.8	
Approach LOS		D			D			C			C	

Intersection Summary

Cycle Length: 130  
 Actuated Cycle Length: 130  
 Offset: 0 (0%), Referenced to phase 2:NBTL, Start of Green  
 Natural Cycle: 120  
 Control Type: Actuated-Coordinated  
 Maximum v/c Ratio: 0.96  
 Intersection Signal Delay: 46.4  
 Intersection LOS: D  
 Intersection Capacity Utilization 58.0%  
 ICU Level of Service B  
 Analysis Period (min) 15

Splits and Phases: 1: Dransfeldt Rd & Lincoln Ave

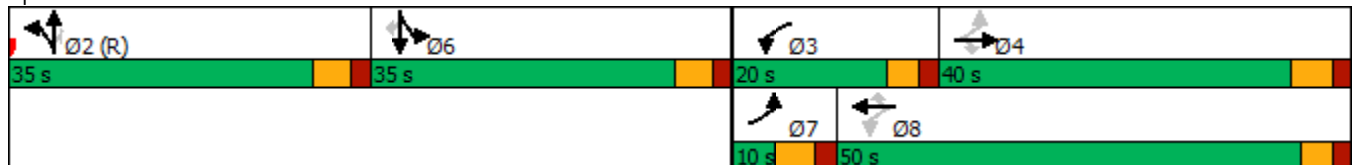

Queues

1: Dransfeldt Rd & Lincoln Ave

09/27/2020



Lane Group	EBL	EBT	EBR	WBL	WBT	WBR	NBL	NBT	NBR	SBL	SBT	SBR
Lane Group Flow (vph)	37	783	148	183	1176	4	85	88	154	3	72	47
v/c Ratio	0.34	0.85	0.28	0.73	0.96	0.01	0.21	0.21	0.30	0.01	0.17	0.10
Control Delay	32.5	55.8	6.0	64.6	50.9	0.0	42.3	42.2	6.7	39.0	41.8	0.4
Queue Delay	0.0	0.0	0.0	0.0	0.0	0.0	0.0	0.0	0.0	0.0	0.0	0.0
Total Delay	32.5	55.8	6.0	64.6	50.9	0.0	42.3	42.2	6.7	39.0	41.8	0.4
Queue Length 50th (ft)	18	327	0	108	532	0	62	64	0	2	49	0
Queue Length 95th (ft)	41	410	45	m177	#662	m0	112	114	49	11	92	0
Internal Link Dist (ft)		347			472			342			209	
Turn Bay Length (ft)	200			330			300			100		
Base Capacity (vph)	109	944	539	270	1228	625	406	417	507	401	422	486
Starvation Cap Reductn	0	0	0	0	0	0	0	0	0	0	0	0
Spillback Cap Reductn	0	0	0	0	0	0	0	0	0	0	0	0
Storage Cap Reductn	0	0	0	0	0	0	0	0	0	0	0	0
Reduced v/c Ratio	0.34	0.83	0.27	0.68	0.96	0.01	0.21	0.21	0.30	0.01	0.17	0.10

Intersection Summary

# 95th percentile volume exceeds capacity, queue may be longer.

Queue shown is maximum after two cycles.

m Volume for 95th percentile queue is metered by upstream signal.

HCM 6th Signalized Intersection Summary  
1: Dransfeldt Rd & Lincoln Ave

Lincoln & Dransfeldt  
09/27/2020

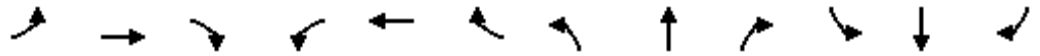

Movement	EBL	EBT	EBR	WBL	WBT	WBR	NBL	NBT	NBR	SBL	SBT	SBR
Lane Configurations												
Traffic Volume (veh/h)	34	720	136	168	1082	4	115	44	142	3	66	43
Future Volume (veh/h)	34	720	136	168	1082	4	115	44	142	3	66	43
Initial Q (Qb), veh	0	0	0	0	0	0	0	0	0	0	0	0
Ped-Bike Adj(A_pbT)	1.00		1.00	1.00		1.00	1.00		1.00	1.00		1.00
Parking Bus, Adj	1.00	1.00	1.00	1.00	1.00	1.00	1.00	1.00	1.00	1.00	1.00	1.00
Work Zone On Approach		No			No			No			No	
Adj Sat Flow, veh/h/ln	1870	1870	1870	1870	1870	1870	1870	1870	1870	1870	1870	1870
Adj Flow Rate, veh/h	37	783	148	183	1176	4	86	102	154	3	72	47
Peak Hour Factor	0.92	0.92	0.92	0.92	0.92	0.92	0.92	0.92	0.92	0.92	0.92	0.92
Percent Heavy Veh, %	2	2	2	2	2	2	2	2	2	2	2	2
Cap, veh/h	104	1023	456	261	1224	546	409	429	364	404	424	360
Arrive On Green	0.02	0.29	0.29	0.09	0.34	0.34	0.23	0.23	0.23	0.23	0.23	0.23
Sat Flow, veh/h	1781	3554	1585	1781	3554	1585	1781	1870	1585	1781	1870	1585
Grp Volume(v), veh/h	37	783	148	183	1176	4	86	102	154	3	72	47
Grp Sat Flow(s),veh/h/ln	1781	1777	1585	1781	1777	1585	1781	1870	1585	1781	1870	1585
Q Serve(g_s), s	1.9	26.2	9.5	9.1	42.1	0.2	5.1	5.8	10.8	0.2	4.0	3.1
Cycle Q Clear(g_c), s	1.9	26.2	9.5	9.1	42.1	0.2	5.1	5.8	10.8	0.2	4.0	3.1
Prop In Lane	1.00		1.00	1.00		1.00	1.00		1.00	1.00		1.00
Lane Grp Cap(c), veh/h	104	1023	456	261	1224	546	409	429	364	404	424	360
V/C Ratio(X)	0.35	0.77	0.32	0.70	0.96	0.01	0.21	0.24	0.42	0.01	0.17	0.13
Avail Cap(c_a), veh/h	120	1023	456	313	1230	549	409	429	364	404	424	360
HCM Platoon Ratio	1.00	1.00	1.00	1.00	1.00	1.00	1.00	1.00	1.00	1.00	1.00	1.00
Upstream Filter(I)	1.00	1.00	1.00	1.00	1.00	1.00	1.00	1.00	1.00	1.00	1.00	1.00
Uniform Delay (d), s/veh	36.7	42.3	36.4	31.4	41.7	28.0	40.5	40.8	42.7	38.9	40.4	40.0
Incr Delay (d2), s/veh	2.0	3.5	0.4	5.4	17.0	0.0	1.2	1.3	3.6	0.0	0.9	0.8
Initial Q Delay(d3),s/veh	0.0	0.0	0.0	0.0	0.0	0.0	0.0	0.0	0.0	0.0	0.0	0.0
%ile BackOfQ(95%),veh/ln	1.6	17.6	6.8	7.7	28.7	0.2	4.3	5.1	8.1	0.1	3.6	2.3
Unsig. Movement Delay, s/veh												
LnGrp Delay(d),s/veh	38.7	45.8	36.8	36.8	58.8	28.0	41.7	42.1	46.3	38.9	41.3	40.8
LnGrp LOS	D	D	D	D	E	C	D	D	D	D	D	D
Approach Vol, veh/h		968			1363			342			122	
Approach Delay, s/veh		44.1			55.7			43.9			41.0	
Approach LOS		D			E			D			D	
Timer - Assigned Phs		2	3	4		6	7	8				
Phs Duration (G+Y+Rc), s		35.3	16.2	43.4		35.0	8.9	50.8				
Change Period (Y+Rc), s		5.5	5.0	6.0		5.5	6.0	* 6				
Max Green Setting (Gmax), s		29.5	15.0	34.0		29.5	4.0	* 45				
Max Q Clear Time (g_c+I1), s		12.8	11.1	28.2		6.0	3.9	44.1				
Green Ext Time (p_c), s		1.2	0.2	2.9		0.5	0.0	0.6				

Intersection Summary

HCM 6th Ctrl Delay	49.6
HCM 6th LOS	D

Notes

- User approved pedestrian interval to be less than phase max green.
- User approved volume balancing among the lanes for turning movement.
- \* HCM 6th computational engine requires equal clearance times for the phases crossing the barrier.

Lanes and Geometrics  
2: Walgreens Access & Lincoln Ave

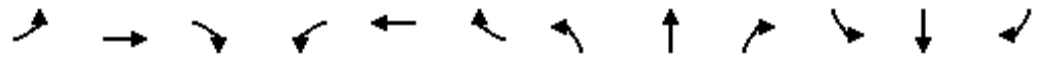

Lane Group	EBL	EBT	EBR	WBL	WBT	WBR	NBL	NBT	NBR	SBL	SBT	SBR
Lane Configurations		↕↕↕			↕↕↕			↕			↕	
Ideal Flow (vphpl)	1900	1900	1900	1900	1900	1900	1900	1900	1900	1900	1900	1900
Lane Width (ft)	12	12	12	12	12	12	12	12	12	12	12	12
Grade (%)		0%			0%			0%			0%	
Storage Length (ft)	0		0	0		0	0		0	0		0
Storage Lanes	0		0	0		0	0		0	0		0
Taper Length (ft)	25			25			25			25		
Lane Util. Factor	0.91	0.91	0.91	0.91	0.91	0.91	1.00	1.00	1.00	1.00	1.00	1.00
Ped Bike Factor												
Frt		0.996			0.996			0.912				0.872
Flt Protected								0.983				0.997
Satd. Flow (prot)	0	5065	0	0	5065	0	0	1670	0	0	1619	0
Flt Permitted								0.983				0.997
Satd. Flow (perm)	0	5065	0	0	5065	0	0	1670	0	0	1619	0
Link Speed (mph)		30			30			30				30
Link Distance (ft)		552			564			131				173
Travel Time (s)		12.5			12.8			3.0				3.9

Intersection Summary

Area Type: Other

Intersection												
Int Delay, s/veh	0.9											
Movement	EBL	EBT	EBR	WBL	WBT	WBR	NBL	NBT	NBR	SBL	SBT	SBR
Lane Configurations	↔↔↔			↔↔↔			↔			↔		
Traffic Vol, veh/h	4	839	22	6	1215	33	7	0	14	2	0	32
Future Vol, veh/h	4	839	22	6	1215	33	7	0	14	2	0	32
Conflicting Peds, #/hr	0	0	0	0	0	0	0	0	0	0	0	0
Sign Control	Free	Free	Free	Free	Free	Free	Stop	Stop	Stop	Stop	Stop	Stop
RT Channelized	-	-	None	-	-	None	-	-	None	-	-	None
Storage Length	-	-	-	-	-	-	-	-	-	-	-	-
Veh in Median Storage, #	-	0	-	-	0	-	-	0	-	-	0	-
Grade, %	-	0	-	-	0	-	-	0	-	-	0	-
Peak Hour Factor	92	92	92	92	92	92	92	92	92	92	92	92
Heavy Vehicles, %	2	2	2	2	2	2	2	2	2	2	2	2
Mvmt Flow	4	912	24	7	1321	36	8	0	15	2	0	35

Major/Minor	Major1			Major2			Minor1			Minor2		
Conflicting Flow All	1357	0	0	936	0	0	1474	2303	468	1726	2297	679
Stage 1	-	-	-	-	-	-	932	932	-	1353	1353	-
Stage 2	-	-	-	-	-	-	542	1371	-	373	944	-
Critical Hdwy	5.34	-	-	5.34	-	-	6.44	6.54	7.14	6.44	6.54	7.14
Critical Hdwy Stg 1	-	-	-	-	-	-	7.34	5.54	-	7.34	5.54	-
Critical Hdwy Stg 2	-	-	-	-	-	-	6.74	5.54	-	6.74	5.54	-
Follow-up Hdwy	3.12	-	-	3.12	-	-	3.82	4.02	3.92	3.82	4.02	3.92
Pot Cap-1 Maneuver	262	-	-	420	-	-	133	38	463	94	38	338
Stage 1	-	-	-	-	-	-	222	343	-	113	216	-
Stage 2	-	-	-	-	-	-	449	212	-	568	339	-
Platoon blocked, %	-	-	-	-	-	-	-	-	-	-	-	-
Mov Cap-1 Maneuver	262	-	-	420	-	-	110	34	463	84	34	338
Mov Cap-2 Maneuver	-	-	-	-	-	-	110	34	-	84	34	-
Stage 1	-	-	-	-	-	-	215	332	-	109	201	-
Stage 2	-	-	-	-	-	-	375	197	-	532	328	-

Approach	EB		WB		NB		SB	
HCM Control Delay, s	0.3		0.4		22.9		19.4	
HCM LOS					C		C	

Minor Lane/Major Mvmt	NBLn1	EBL	EBT	EBR	WBL	WBT	WBR	SBLn1
Capacity (veh/h)	224	262	-	-	420	-	-	287
HCM Lane V/C Ratio	0.102	0.017	-	-	0.016	-	-	0.129
HCM Control Delay (s)	22.9	19	0.2	-	13.7	0.3	-	19.4
HCM Lane LOS	C	C	A	-	B	A	-	C
HCM 95th %tile Q(veh)	0.3	0.1	-	-	0	-	-	0.4

Lanes and Geometrics  
3: Parker Rd & Lincoln Ave



Lane Group	EBL	EBT	EBR	WBL	WBT	WBR	NBL	NBT	NBR	SBL	SBT	SBR
Lane Configurations												
Ideal Flow (vphpl)	1900	1900	1900	1900	1900	1900	1900	1900	1900	1900	1900	1900
Lane Width (ft)	12	12	12	12	12	12	12	12	12	12	12	12
Grade (%)		0%			0%			0%			0%	
Storage Length (ft)	275		0	200		0	500		0	400		0
Storage Lanes	2		1	2		1	2		1	2		1
Taper Length (ft)	25			25			25			25		
Lane Util. Factor	0.97	0.95	1.00	0.97	0.95	1.00	0.97	0.91	1.00	0.97	0.91	1.00
Ped Bike Factor												
Frt			0.850			0.850			0.850			0.850
Flt Protected	0.950			0.950			0.950			0.950		
Satd. Flow (prot)	3433	3539	1583	3433	3539	1583	3433	5085	1583	3433	5085	1583
Flt Permitted	0.950			0.950			0.950			0.950		
Satd. Flow (perm)	3433	3539	1583	3433	3539	1583	3433	5085	1583	3433	5085	1583
Right Turn on Red			Yes			Yes			Yes			Yes
Satd. Flow (RTOR)			245			357			151			206
Link Speed (mph)		30			30			30			30	
Link Distance (ft)		564			615			787			768	
Travel Time (s)		12.8			14.0			17.9			17.5	

Intersection Summary

Area Type: Other

Timings  
3: Parker Rd & Lincoln Ave

Lane Group	EBL	EBT	EBR	WBL	WBT	WBR	NBL	NBT	NBR	SBL	SBT	SBR
Lane Configurations												
Traffic Volume (vph)	249	381	225	151	612	377	372	1495	89	208	1253	270
Future Volume (vph)	249	381	225	151	612	377	372	1495	89	208	1253	270
Turn Type	Prot	NA	Perm	Prot	NA	Free	Prot	NA	Perm	Prot	NA	Free
Protected Phases	7	4		3	8		5	2		1	6	
Permitted Phases			4			Free			2			Free
Detector Phase	7	4	4	3	8		5	2	2	1	6	
Switch Phase												
Minimum Initial (s)	5.0	5.0	5.0	5.0	5.0		5.0	5.0	5.0	5.0	5.0	
Minimum Split (s)	10.0	35.0	35.0	10.0	35.0		15.0	30.5	30.5	10.0	30.5	
Total Split (s)	18.0	49.0	49.0	11.0	42.0		20.0	49.0	49.0	21.0	50.0	
Total Split (%)	13.8%	37.7%	37.7%	8.5%	32.3%		15.4%	37.7%	37.7%	16.2%	38.5%	
Yellow Time (s)	3.0	4.0	4.0	3.0	4.0		3.0	4.5	4.5	3.0	4.5	
All-Red Time (s)	2.0	2.0	2.0	2.0	2.0		2.0	2.0	2.0	2.0	2.0	
Lost Time Adjust (s)	0.0	0.0	0.0	0.0	0.0		0.0	0.0	0.0	0.0	0.0	
Total Lost Time (s)	5.0	6.0	6.0	5.0	6.0		5.0	6.5	6.5	5.0	6.5	
Lead/Lag	Lead	Lag	Lag	Lead	Lag		Lead	Lag	Lag	Lead	Lag	
Lead-Lag Optimize?	Yes	Yes	Yes	Yes	Yes		Yes	Yes	Yes	Yes	Yes	
Recall Mode	None	None	None	None	None		None	C-Max	C-Max	None	C-Max	
Act Effct Green (s)	12.7	37.4	37.4	6.0	30.6	130.0	19.2	50.6	50.6	13.5	44.9	130.0
Actuated g/C Ratio	0.10	0.29	0.29	0.05	0.24	1.00	0.15	0.39	0.39	0.10	0.35	1.00
v/c Ratio	0.81	0.41	0.39	1.04	0.80	0.26	0.80	0.82	0.14	0.63	0.78	0.19
Control Delay	68.4	64.1	35.0	141.1	54.3	0.4	66.2	40.8	1.1	63.9	42.1	0.3
Queue Delay	0.0	0.0	0.0	0.0	0.0	0.0	0.0	0.0	0.0	0.0	0.0	0.0
Total Delay	68.4	64.1	35.0	141.1	54.3	0.4	66.2	40.8	1.1	63.9	42.1	0.3
LOS	E	E	C	F	D	A	E	D	A	E	D	A
Approach Delay		57.7			47.9			43.8			38.2	
Approach LOS		E			D			D			D	

Intersection Summary

Cycle Length: 130  
 Actuated Cycle Length: 130  
 Offset: 0 (0%), Referenced to phase 2:NBT and 6:SBT, Start of Green  
 Natural Cycle: 95  
 Control Type: Actuated-Coordinated  
 Maximum v/c Ratio: 1.04  
 Intersection Signal Delay: 45.0  
 Intersection LOS: D  
 Intersection Capacity Utilization 77.6%  
 ICU Level of Service D  
 Analysis Period (min) 15

Splits and Phases: 3: Parker Rd & Lincoln Ave

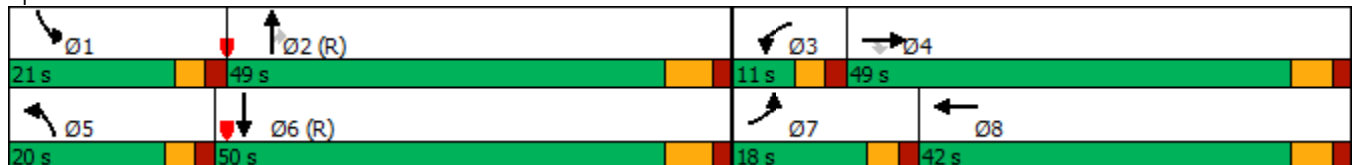

Queues  
3: Parker Rd & Lincoln Ave

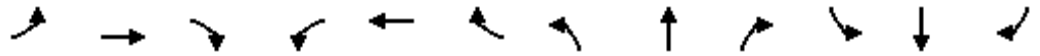

Lane Group	EBL	EBT	EBR	WBL	WBT	WBR	NBL	NBT	NBR	SBL	SBT	SBR
Lane Group Flow (vph)	271	414	245	164	665	410	404	1625	97	226	1362	293
v/c Ratio	0.81	0.41	0.39	1.04	0.80	0.26	0.80	0.82	0.14	0.63	0.78	0.19
Control Delay	68.4	64.1	35.0	141.1	54.3	0.4	66.2	40.8	1.1	63.9	42.1	0.3
Queue Delay	0.0	0.0	0.0	0.0	0.0	0.0	0.0	0.0	0.0	0.0	0.0	0.0
Total Delay	68.4	64.1	35.0	141.1	54.3	0.4	66.2	40.8	1.1	63.9	42.1	0.3
Queue Length 50th (ft)	124	188	134	~76	277	0	170	452	0	95	380	0
Queue Length 95th (ft)	m155	m232	m191	#152	332	0	#290	#606	7	136	441	0
Internal Link Dist (ft)		484			535			707			688	
Turn Bay Length (ft)	275			200			500			400		
Base Capacity (vph)	343	1170	687	158	980	1583	508	1980	708	422	1756	1583
Starvation Cap Reductn	0	0	0	0	0	0	0	0	0	0	0	0
Spillback Cap Reductn	0	0	0	0	0	0	0	0	0	0	0	0
Storage Cap Reductn	0	0	0	0	0	0	0	0	0	0	0	0
Reduced v/c Ratio	0.79	0.35	0.36	1.04	0.68	0.26	0.80	0.82	0.14	0.54	0.78	0.19

Intersection Summary

- ~ Volume exceeds capacity, queue is theoretically infinite.  
Queue shown is maximum after two cycles.
- # 95th percentile volume exceeds capacity, queue may be longer.  
Queue shown is maximum after two cycles.
- m Volume for 95th percentile queue is metered by upstream signal.

HCM 6th Signalized Intersection Summary  
3: Parker Rd & Lincoln Ave

Lincoln & Dransfeldt

09/27/2020



Movement	EBL	EBT	EBR	WBL	WBT	WBR	NBL	NBT	NBR	SBL	SBT	SBR
Lane Configurations	↖↗	↖↖	↖	↖↗	↖↖	↖	↖↗	↖↖↖	↖	↖↗	↖↖↖	↖
Traffic Volume (veh/h)	249	381	225	151	612	377	372	1495	89	208	1253	270
Future Volume (veh/h)	249	381	225	151	612	377	372	1495	89	208	1253	270
Initial Q (Qb), veh	0	0	0	0	0	0	0	0	0	0	0	0
Ped-Bike Adj(A_pbT)	1.00		1.00	1.00		1.00	1.00		1.00	1.00		1.00
Parking Bus, Adj	1.00	1.00	1.00	1.00	1.00	1.00	1.00	1.00	1.00	1.00	1.00	1.00
Work Zone On Approach		No			No			No			No	
Adj Sat Flow, veh/h/ln	1870	1870	1870	1870	1870	1870	1870	1870	1870	1870	1870	1870
Adj Flow Rate, veh/h	271	414	0	164	665	0	404	1625	0	226	1362	0
Peak Hour Factor	0.92	0.92	0.92	0.92	0.92	0.92	0.92	0.92	0.92	0.92	0.92	0.92
Percent Heavy Veh, %	2	2	2	2	2	2	2	2	2	2	2	2
Cap, veh/h	325	954		159	784		399	2196		284	2027	
Arrive On Green	0.03	0.09	0.00	0.05	0.22	0.00	0.12	0.43	0.00	0.08	0.40	0.00
Sat Flow, veh/h	3456	3554	1585	3456	3554	1585	3456	5106	1585	3456	5106	1585
Grp Volume(v), veh/h	271	414	0	164	665	0	404	1625	0	226	1362	0
Grp Sat Flow(s),veh/h/ln	1728	1777	1585	1728	1777	1585	1728	1702	1585	1728	1702	1585
Q Serve(g_s), s	10.1	14.4	0.0	6.0	23.3	0.0	15.0	34.6	0.0	8.3	28.5	0.0
Cycle Q Clear(g_c), s	10.1	14.4	0.0	6.0	23.3	0.0	15.0	34.6	0.0	8.3	28.5	0.0
Prop In Lane	1.00		1.00	1.00		1.00	1.00		1.00	1.00		1.00
Lane Grp Cap(c), veh/h	325	954		159	784		399	2196		284	2027	
V/C Ratio(X)	0.83	0.43		1.03	0.85		1.01	0.74		0.79	0.67	
Avail Cap(c_a), veh/h	346	1175		159	984		399	2196		425	2027	
HCM Platoon Ratio	0.33	0.33	0.33	1.00	1.00	1.00	1.00	1.00	1.00	1.00	1.00	1.00
Upstream Filter(I)	1.00	1.00	0.00	1.00	1.00	0.00	1.00	1.00	0.00	1.00	1.00	0.00
Uniform Delay (d), s/veh	62.0	49.9	0.0	62.0	48.6	0.0	57.5	31.0	0.0	58.6	32.2	0.0
Incr Delay (d2), s/veh	15.3	0.3	0.0	78.9	5.8	0.0	48.4	2.3	0.0	6.1	1.8	0.0
Initial Q Delay(d3),s/veh	0.0	0.0	0.0	0.0	0.0	0.0	0.0	0.0	0.0	0.0	0.0	0.0
%ile BackOfQ(95%),veh/ln	9.2	11.2	0.0	7.9	16.4	0.0	14.3	20.8	0.0	7.0	17.7	0.0
Unsig. Movement Delay, s/veh												
LnGrp Delay(d),s/veh	77.2	50.2	0.0	140.9	54.4	0.0	105.9	33.3	0.0	64.7	34.0	0.0
LnGrp LOS	E	D		F	D		F	C		E	C	
Approach Vol, veh/h		685	A		829	A		2029	A		1588	A
Approach Delay, s/veh		60.9			71.5			47.7			38.4	
Approach LOS		E			E			D			D	
Timer - Assigned Phs	1	2	3	4	5	6	7	8				
Phs Duration (G+Y+Rc), s	15.7	62.4	11.0	40.9	20.0	58.1	17.2	34.7				
Change Period (Y+Rc), s	5.0	6.5	5.0	6.0	5.0	6.5	5.0	6.0				
Max Green Setting (Gmax), s	16.0	42.5	6.0	43.0	15.0	43.5	13.0	36.0				
Max Q Clear Time (g_c+I1), s	10.3	36.6	8.0	16.4	17.0	30.5	12.1	25.3				
Green Ext Time (p_c), s	0.4	4.6	0.0	2.9	0.0	7.7	0.1	3.3				

Intersection Summary

HCM 6th Ctrl Delay	50.4
HCM 6th LOS	D

Notes

Unsignalized Delay for [NBR, EBR, WBR, SBR] is excluded from calculations of the approach delay and intersection delay.

Lanes and Geometrics  
4: Dransfeldt Rd & Lowe's Access



Lane Group	EBL	EBR	NBL	NBT	SBT	SBR
Lane Configurations						
Ideal Flow (vphp)	1900	1900	1900	1900	1900	1900
Lane Width (ft)	12	12	12	12	12	12
Grade (%)	0%			0%	0%	
Storage Length (ft)	0	0	125			0
Storage Lanes	1	0	1			0
Taper Length (ft)	25		25			
Lane Util. Factor	1.00	1.00	1.00	0.95	1.00	1.00
Ped Bike Factor						
Frt	0.938				0.985	
Flt Protected	0.974		0.950			
Satd. Flow (prot)	1702	0	1770	3539	1835	0
Flt Permitted	0.974		0.950			
Satd. Flow (perm)	1702	0	1770	3539	1835	0
Link Speed (mph)	30			30	30	
Link Distance (ft)	400			232	422	
Travel Time (s)	9.1			5.3	9.6	

Intersection Summary

Area Type: Other

Intersection						
Int Delay, s/veh	0.9					
Movement	EBL	EBR	NBL	NBT	SBT	SBR
Lane Configurations	↔		↔	↑↑	↑	
Traffic Vol, veh/h	24	20	16	277	328	42
Future Vol, veh/h	24	20	16	277	328	42
Conflicting Peds, #/hr	0	0	0	0	0	0
Sign Control	Stop	Stop	Free	Free	Free	Free
RT Channelized	-	None	-	None	-	None
Storage Length	0	-	125	-	-	-
Veh in Median Storage, #	0	-	-	0	0	-
Grade, %	0	-	-	0	0	-
Peak Hour Factor	92	92	92	92	92	92
Heavy Vehicles, %	2	2	2	2	2	2
Mvmt Flow	26	22	17	301	357	46





























Major/Minor	Minor2	Major1	Major2			
Conflicting Flow All	565	380	403	0	-	0
Stage 1	380	-	-	-	-	-
Stage 2	185	-	-	-	-	-
Critical Hdwy	6.63	6.23	4.13	-	-	-
Critical Hdwy Stg 1	5.43	-	-	-	-	-
Critical Hdwy Stg 2	5.83	-	-	-	-	-
Follow-up Hdwy	3.519	3.319	2.219	-	-	-
Pot Cap-1 Maneuver	470	666	1154	-	-	-
Stage 1	690	-	-	-	-	-
Stage 2	829	-	-	-	-	-
Platoon blocked, %				-	-	-
Mov Cap-1 Maneuver	463	666	1154	-	-	-
Mov Cap-2 Maneuver	463	-	-	-	-	-
Stage 1	680	-	-	-	-	-
Stage 2	829	-	-	-	-	-

Approach	EB	NB	SB
HCM Control Delay, s	12.4	0.4	0
HCM LOS	B		

Minor Lane/Major Mvmt	NBL	NBT	EBLn1	SBT	SBR
Capacity (veh/h)	1154	-	537	-	-
HCM Lane V/C Ratio	0.015	-	0.089	-	-
HCM Control Delay (s)	8.2	-	12.4	-	-
HCM Lane LOS	A	-	B	-	-
HCM 95th %tile Q(veh)	0	-	0.3	-	-

Lanes and Geometrics  
1: Dransfeldt Rd & Lincoln Ave

Lincoln & Dransfeldt  
09/27/2020

												
Lane Group	EBL	EBT	EBR	WBL	WBT	WBR	NBL	NBT	NBR	SBL	SBT	SBR
Lane Configurations		 			 			 			 	
Ideal Flow (vphpl)	1900	1900	1900	1900	1900	1900	1900	1900	1900	1900	1900	1900
Lane Width (ft)	12	12	12	12	12	12	12	12	12	12	12	12
Grade (%)		0%			0%			0%			0%	
Storage Length (ft)	200		0	330		0	300		0	100		0
Storage Lanes	1		1	1		1	1		1	1		1
Taper Length (ft)	25			25			25			25		
Lane Util. Factor	1.00	0.95	1.00	1.00	0.95	1.00	0.95	0.95	1.00	1.00	1.00	1.00
Ped Bike Factor			0.850			0.850			0.850			0.850
Flt Protected	0.950			0.950			0.950	0.986		0.950		
Satd. Flow (prot)	1770	3539	1583	1770	3539	1583	1681	1745	1583	1770	1863	1583
Flt Permitted	0.215			0.097			0.950	0.986		0.950		
Satd. Flow (perm)	400	3539	1583	181	3539	1583	1681	1745	1583	1770	1863	1583
Right Turn on Red			Yes			Yes			Yes			Yes
Satd. Flow (RTOR)			159			117			323			164
Link Speed (mph)		30			30			30			30	
Link Distance (ft)		427			552			422			289	
Travel Time (s)		9.7			12.5			9.6			6.6	

Intersection Summary

Area Type: Other

Timings  
1: Dransfeldt Rd & Lincoln Ave

Lincoln & Dransfeldt  
09/27/2020

Lane Group	EBL	EBT	EBR	WBL	WBT	WBR	NBL	NBT	NBR	SBL	SBT	SBR
Lane Configurations												
Traffic Volume (vph)	78	1016	146	179	756	19	217	123	297	14	61	78
Future Volume (vph)	78	1016	146	179	756	19	217	123	297	14	61	78
Turn Type	pm+pt	NA	Perm	pm+pt	NA	Perm	Split	NA	Perm	Split	NA	Perm
Protected Phases	7	4		3	8		2	2		6	6	
Permitted Phases	4		4	8		8			2			6
Detector Phase	7	4	4	3	8	8	2	2	2	6	6	6
Switch Phase												
Minimum Initial (s)	3.0	10.0	10.0	4.0	10.0	10.0	5.0	5.0	5.0	5.0	5.0	5.0
Minimum Split (s)	10.0	40.0	40.0	9.5	35.0	35.0	35.0	35.0	35.0	35.0	35.0	35.0
Total Split (s)	10.0	40.0	40.0	20.0	50.0	50.0	38.0	38.0	38.0	32.0	32.0	32.0
Total Split (%)	7.7%	30.8%	30.8%	15.4%	38.5%	38.5%	29.2%	29.2%	29.2%	24.6%	24.6%	24.6%
Yellow Time (s)	4.0	4.0	4.0	3.0	3.0	3.0	3.5	3.5	3.5	3.5	3.5	3.5
All-Red Time (s)	2.0	2.0	2.0	2.0	2.0	2.0	2.0	2.0	2.0	2.0	2.0	2.0
Lost Time Adjust (s)	0.0	0.0	0.0	0.0	0.0	0.0	0.0	0.0	0.0	0.0	0.0	0.0
Total Lost Time (s)	6.0	6.0	6.0	5.0	5.0	5.0	5.5	5.5	5.5	5.5	5.5	5.5
Lead/Lag	Lead	Lag	Lag	Lead	Lag	Lag						
Lead-Lag Optimize?	Yes	Yes	Yes	Yes	Yes	Yes						
Recall Mode	None	None	None	None	None	None	C-Max	C-Max	C-Max	Max	Max	Max
Act Effct Green (s)	39.2	35.2	35.2	55.0	45.0	45.0	32.5	32.5	32.5	26.5	26.5	26.5
Actuated g/C Ratio	0.30	0.27	0.27	0.42	0.35	0.35	0.25	0.25	0.25	0.20	0.20	0.20
v/c Ratio	0.52	1.15	0.29	0.80	0.67	0.03	0.43	0.43	0.51	0.04	0.17	0.19
Control Delay	40.0	122.8	7.0	74.7	35.5	0.4	44.9	44.7	7.1	42.1	44.2	0.9
Queue Delay	0.0	0.0	0.0	0.0	0.0	0.0	0.0	0.0	0.0	0.0	0.0	0.0
Total Delay	40.0	122.8	7.0	74.7	35.5	0.4	44.9	44.7	7.1	42.1	44.2	0.9
LOS	D	F	A	E	D	A	D	D	A	D	D	A
Approach Delay		103.9			42.1			27.2			21.9	
Approach LOS		F			D			C			C	

Intersection Summary

Cycle Length: 130  
 Actuated Cycle Length: 130  
 Offset: 0 (0%), Referenced to phase 2:NBTL, Start of Green  
 Natural Cycle: 130  
 Control Type: Actuated-Coordinated  
 Maximum v/c Ratio: 1.15  
 Intersection Signal Delay: 63.6  
 Intersection LOS: E  
 Intersection Capacity Utilization 67.7%  
 ICU Level of Service C  
 Analysis Period (min) 15

Splits and Phases: 1: Dransfeldt Rd & Lincoln Ave

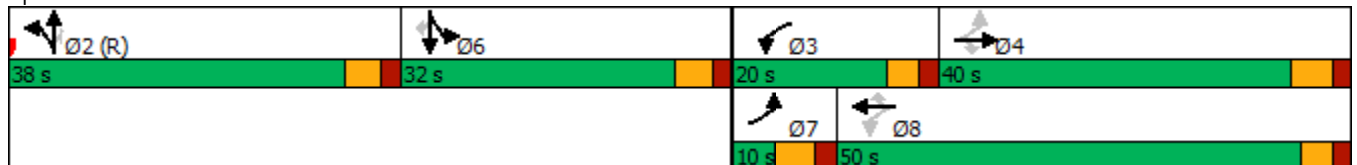

Queues  
1: Dransfeldt Rd & Lincoln Ave

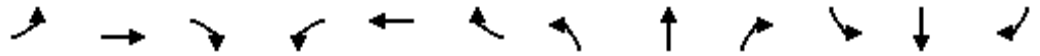

Lane Group	EBL	EBT	EBR	WBL	WBT	WBR	NBL	NBT	NBR	SBL	SBT	SBR
Lane Group Flow (vph)	85	1104	159	195	822	21	182	188	323	15	66	85
v/c Ratio	0.52	1.15	0.29	0.80	0.67	0.03	0.43	0.43	0.51	0.04	0.17	0.19
Control Delay	40.0	122.8	7.0	74.7	35.5	0.4	44.9	44.7	7.1	42.1	44.2	0.9
Queue Delay	0.0	0.0	0.0	0.0	0.0	0.0	0.0	0.0	0.0	0.0	0.0	0.0
Total Delay	40.0	122.8	7.0	74.7	35.5	0.4	44.9	44.7	7.1	42.1	44.2	0.9
Queue Length 50th (ft)	43	~591	0	126	200	0	136	141	0	10	46	0
Queue Length 95th (ft)	79	#727	54	m#219	361	m0	214	218	76	31	88	0
Internal Link Dist (ft)		347			472			342			209	
Turn Bay Length (ft)	200			330			300			100		
Base Capacity (vph)	163	959	545	259	1225	624	420	436	638	360	379	453
Starvation Cap Reductn	0	0	0	0	0	0	0	0	0	0	0	0
Spillback Cap Reductn	0	0	0	0	0	0	0	0	0	0	0	0
Storage Cap Reductn	0	0	0	0	0	0	0	0	0	0	0	0
Reduced v/c Ratio	0.52	1.15	0.29	0.75	0.67	0.03	0.43	0.43	0.51	0.04	0.17	0.19

Intersection Summary

- ~ Volume exceeds capacity, queue is theoretically infinite.  
Queue shown is maximum after two cycles.
- # 95th percentile volume exceeds capacity, queue may be longer.  
Queue shown is maximum after two cycles.
- m Volume for 95th percentile queue is metered by upstream signal.

HCM 6th Signalized Intersection Summary  
1: Dransfeldt Rd & Lincoln Ave

Lincoln & Dransfeldt  
09/27/2020

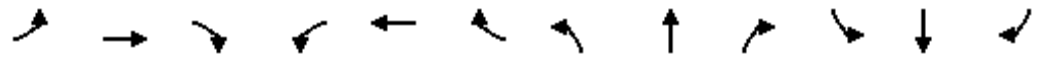

Movement	EBL	EBT	EBR	WBL	WBT	WBR	NBL	NBT	NBR	SBL	SBT	SBR
Lane Configurations												
Traffic Volume (veh/h)	78	1016	146	179	756	19	217	123	297	14	61	78
Future Volume (veh/h)	78	1016	146	179	756	19	217	123	297	14	61	78
Initial Q (Qb), veh	0	0	0	0	0	0	0	0	0	0	0	0
Ped-Bike Adj(A_pbT)	1.00		1.00	1.00		1.00	1.00		1.00	1.00		1.00
Parking Bus, Adj	1.00	1.00	1.00	1.00	1.00	1.00	1.00	1.00	1.00	1.00	1.00	1.00
Work Zone On Approach		No			No			No			No	
Adj Sat Flow, veh/h/ln	1870	1870	1870	1870	1870	1870	1870	1870	1870	1870	1870	1870
Adj Flow Rate, veh/h	85	1104	159	195	822	21	185	205	323	15	66	85
Peak Hour Factor	0.92	0.92	0.92	0.92	0.92	0.92	0.92	0.92	0.92	0.92	0.92	0.92
Percent Heavy Veh, %	2	2	2	2	2	2	2	2	2	2	2	2
Cap, veh/h	183	929	415	222	1126	502	484	508	430	363	381	323
Arrive On Green	0.03	0.26	0.26	0.09	0.32	0.32	0.27	0.27	0.27	0.20	0.20	0.20
Sat Flow, veh/h	1781	3554	1585	1781	3554	1585	1781	1870	1585	1781	1870	1585
Grp Volume(v), veh/h	85	1104	159	195	822	21	185	205	323	15	66	85
Grp Sat Flow(s),veh/h/ln	1781	1777	1585	1781	1777	1585	1781	1870	1585	1781	1870	1585
Q Serve(g_s), s	4.0	34.0	10.7	10.1	26.7	1.2	11.0	11.7	24.2	0.9	3.8	5.9
Cycle Q Clear(g_c), s	4.0	34.0	10.7	10.1	26.7	1.2	11.0	11.7	24.2	0.9	3.8	5.9
Prop In Lane	1.00		1.00	1.00		1.00	1.00		1.00	1.00		1.00
Lane Grp Cap(c), veh/h	183	929	415	222	1126	502	484	508	430	363	381	323
V/C Ratio(X)	0.46	1.19	0.38	0.88	0.73	0.04	0.38	0.40	0.75	0.04	0.17	0.26
Avail Cap(c_a), veh/h	183	929	415	261	1230	549	484	508	430	363	381	323
HCM Platoon Ratio	1.00	1.00	1.00	1.00	1.00	1.00	1.00	1.00	1.00	1.00	1.00	1.00
Upstream Filter(I)	1.00	1.00	1.00	1.00	1.00	1.00	1.00	1.00	1.00	1.00	1.00	1.00
Uniform Delay (d), s/veh	38.0	48.0	39.4	33.9	39.5	30.7	38.5	38.7	43.3	41.6	42.7	43.5
Incr Delay (d2), s/veh	1.8	95.4	0.6	24.2	2.0	0.0	2.3	2.4	11.4	0.2	1.0	2.0
Initial Q Delay(d3),s/veh	0.0	0.0	0.0	0.0	0.0	0.0	0.0	0.0	0.0	0.0	0.0	0.0
%ile BackOfQ(95%),veh/ln	1.2	39.5	7.7	9.8	17.7	0.8	8.9	9.6	16.3	0.7	3.4	0.3
Unsig. Movement Delay, s/veh												
LnGrp Delay(d),s/veh	39.9	143.4	40.0	58.1	41.5	30.8	40.8	41.1	54.7	41.8	43.7	45.5
LnGrp LOS	D	F	D	E	D	C	D	D	D	D	D	D
Approach Vol, veh/h		1348			1038			713			166	
Approach Delay, s/veh		124.7			44.4			47.2			44.5	
Approach LOS		F			D			D			D	
Timer - Assigned Phs		2	3	4		6	7	8				
Phs Duration (G+Y+Rc), s		40.8	17.2	40.0		32.0	10.0	47.2				
Change Period (Y+Rc), s		5.5	5.0	6.0		5.5	6.0	* 6				
Max Green Setting (Gmax), s		32.5	15.0	34.0		26.5	4.0	* 45				
Max Q Clear Time (g_c+I1), s		26.2	12.1	36.0		7.9	6.0	28.7				
Green Ext Time (p_c), s		1.7	0.1	0.0		0.6	0.0	5.4				

Intersection Summary

HCM 6th Ctrl Delay	78.1
HCM 6th LOS	E

Notes

- User approved pedestrian interval to be less than phase max green.
- User approved volume balancing among the lanes for turning movement.
- \* HCM 6th computational engine requires equal clearance times for the phases crossing the barrier.

Lanes and Geometrics  
 2: Walgreens Access & Lincoln Ave

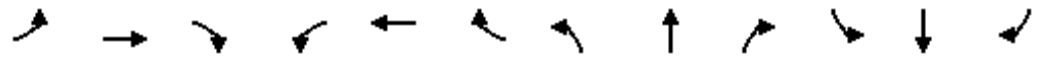

Lane Group	EBL	EBT	EBR	WBL	WBT	WBR	NBL	NBT	NBR	SBL	SBT	SBR
Lane Configurations		↕↕↕			↕↕↕			↕			↕	
Ideal Flow (vphpl)	1900	1900	1900	1900	1900	1900	1900	1900	1900	1900	1900	1900
Lane Width (ft)	12	12	12	12	12	12	12	12	12	12	12	12
Grade (%)		0%			0%			0%			0%	
Storage Length (ft)	0		0	0		0	0		0	0		0
Storage Lanes	0		0	0		0	0		0	0		0
Taper Length (ft)	25			25			25			25		
Lane Util. Factor	0.91	0.91	0.91	0.91	0.91	0.91	1.00	1.00	1.00	1.00	1.00	1.00
Ped Bike Factor												
Frt		0.994			0.988			0.882			0.871	
Flt Protected		0.999						0.996			0.998	
Satd. Flow (prot)	0	5050	0	0	5024	0	0	1636	0	0	1619	0
Flt Permitted		0.999						0.996			0.998	
Satd. Flow (perm)	0	5050	0	0	5024	0	0	1636	0	0	1619	0
Link Speed (mph)		30			30			30			30	
Link Distance (ft)		552			564			131			173	
Travel Time (s)		12.5			12.8			3.0			3.9	

Intersection Summary

Area Type: Other

Intersection												
Int Delay, s/veh	2.8											
Movement	EBL	EBT	EBR	WBL	WBT	WBR	NBL	NBT	NBR	SBL	SBT	SBR
Lane Configurations	↔↔↔			↔↔↔				↔			↔	
Traffic Vol, veh/h	17	1260	50	7	850	73	4	3	43	4	1	100
Future Vol, veh/h	17	1260	50	7	850	73	4	3	43	4	1	100
Conflicting Peds, #/hr	0	0	0	0	0	0	0	0	0	0	0	0
Sign Control	Free	Free	Free	Free	Free	Free	Stop	Stop	Stop	Stop	Stop	Stop
RT Channelized	-	-	None	-	-	None	-	-	None	-	-	None
Storage Length	-	-	-	-	-	-	-	-	-	-	-	-
Veh in Median Storage, #	-	0	-	-	0	-	-	0	-	-	0	-
Grade, %	-	0	-	-	0	-	-	0	-	-	0	-
Peak Hour Factor	92	92	92	92	92	92	92	92	92	92	92	92
Heavy Vehicles, %	2	2	2	2	2	2	2	2	2	2	2	2
Mvmt Flow	18	1370	54	8	924	79	4	3	47	4	1	109

Major/Minor	Major1			Major2			Minor1			Minor2		
Conflicting Flow All	1003	0	0	1424	0	0	1819	2452	712	1566	2440	502
Stage 1	-	-	-	-	-	-	1433	1433	-	980	980	-
Stage 2	-	-	-	-	-	-	386	1019	-	586	1460	-
Critical Hdwy	5.34	-	-	5.34	-	-	6.44	6.54	7.14	6.44	6.54	7.14
Critical Hdwy Stg 1	-	-	-	-	-	-	7.34	5.54	-	7.34	5.54	-
Critical Hdwy Stg 2	-	-	-	-	-	-	6.74	5.54	-	6.74	5.54	-
Follow-up Hdwy	3.12	-	-	3.12	-	-	3.82	4.02	3.92	3.82	4.02	3.92
Pot Cap-1 Maneuver	390	-	-	243	-	-	82	30	322	117	31	440
Stage 1	-	-	-	-	-	-	99	198	-	206	326	-
Stage 2	-	-	-	-	-	-	558	313	-	422	192	-
Platoon blocked, %	-	-	-	-	-	-	-	-	-	-	-	-
Mov Cap-1 Maneuver	390	-	-	243	-	-	46	21	322	69	22	440
Mov Cap-2 Maneuver	-	-	-	-	-	-	46	21	-	69	22	-
Stage 1	-	-	-	-	-	-	77	153	-	159	301	-
Stage 2	-	-	-	-	-	-	387	289	-	273	148	-

Approach	EB			WB			NB			SB		
HCM Control Delay, s	1.2			0.6			47.1			22.5		
HCM LOS							E			C		

Minor Lane/Major Mvmt	NBLn1	EBL	EBT	EBR	WBL	WBT	WBR	SBLn1
Capacity (veh/h)	138	390	-	-	243	-	-	318
HCM Lane V/C Ratio	0.394	0.047	-	-	0.031	-	-	0.359
HCM Control Delay (s)	47.1	14.7	1.1	-	20.3	0.5	-	22.5
HCM Lane LOS	E	B	A	-	C	A	-	C
HCM 95th %tile Q(veh)	1.7	0.1	-	-	0.1	-	-	1.6

Lanes and Geometrics  
3: Parker Rd & Lincoln Ave



Lane Group	EBL	EBT	EBR	WBL	WBT	WBR	NBL	NBT	NBR	SBL	SBT	SBR
Lane Configurations												
Ideal Flow (vphpl)	1900	1900	1900	1900	1900	1900	1900	1900	1900	1900	1900	1900
Lane Width (ft)	12	12	12	12	12	12	12	12	12	12	12	12
Grade (%)		0%			0%			0%			0%	
Storage Length (ft)	275		0	200		0	500		0	400		0
Storage Lanes	2		1	2		1	2		1	2		1
Taper Length (ft)	25			25			25			25		
Lane Util. Factor	0.97	0.95	1.00	0.97	0.95	1.00	0.97	0.91	1.00	0.97	0.91	1.00
Ped Bike Factor												
Frt			0.850			0.850			0.850			0.850
Flt Protected	0.950			0.950			0.950			0.950		
Satd. Flow (prot)	3433	3539	1583	3433	3539	1583	3433	5085	1583	3433	5085	1583
Flt Permitted	0.950			0.950			0.950			0.950		
Satd. Flow (perm)	3433	3539	1583	3433	3539	1583	3433	5085	1583	3433	5085	1583
Right Turn on Red			Yes			Yes			Yes			Yes
Satd. Flow (RTOR)			259			250			151			206
Link Speed (mph)		30			30			30			30	
Link Distance (ft)		564			615			787			768	
Travel Time (s)		12.8			14.0			17.9			17.5	

Intersection Summary

Area Type: Other

Timings  
3: Parker Rd & Lincoln Ave

Lane Group	EBL	EBT	EBR	WBL	WBT	WBR	NBL	NBT	NBR	SBL	SBT	SBR
Lane Configurations												
Traffic Volume (vph)	480	545	282	140	332	230	338	1751	118	383	2119	260
Future Volume (vph)	480	545	282	140	332	230	338	1751	118	383	2119	260
Turn Type	Prot	NA	Perm	Prot	NA	Free	Prot	NA	Perm	Prot	NA	Free
Protected Phases	7	4		3	8		5	2		1	6	
Permitted Phases			4			Free			2			Free
Detector Phase	7	4	4	3	8		5	2	2	1	6	
Switch Phase												
Minimum Initial (s)	5.0	5.0	5.0	5.0	5.0		5.0	5.0	5.0	5.0	5.0	
Minimum Split (s)	10.0	35.0	35.0	10.0	35.0		15.0	30.5	30.5	10.0	30.5	
Total Split (s)	18.0	49.0	49.0	11.0	42.0		20.0	49.0	49.0	21.0	50.0	
Total Split (%)	13.8%	37.7%	37.7%	8.5%	32.3%		15.4%	37.7%	37.7%	16.2%	38.5%	
Yellow Time (s)	3.0	4.0	4.0	3.0	4.0		3.0	4.5	4.5	3.0	4.5	
All-Red Time (s)	2.0	2.0	2.0	2.0	2.0		2.0	2.0	2.0	2.0	2.0	
Lost Time Adjust (s)	0.0	0.0	0.0	0.0	0.0		0.0	0.0	0.0	0.0	0.0	
Total Lost Time (s)	5.0	6.0	6.0	5.0	6.0		5.0	6.5	6.5	5.0	6.5	
Lead/Lag	Lead	Lag	Lag	Lead	Lag		Lead	Lag	Lag	Lead	Lag	
Lead-Lag Optimize?	Yes	Yes	Yes	Yes	Yes		Yes	Yes	Yes	Yes	Yes	
Recall Mode	None	None	None	None	None		None	C-Max	C-Max	None	C-Max	
Act Effct Green (s)	13.0	30.4	30.4	6.0	23.4	130.0	19.4	49.2	49.2	21.9	51.7	130.0
Actuated g/C Ratio	0.10	0.23	0.23	0.05	0.18	1.00	0.15	0.38	0.38	0.17	0.40	1.00
v/c Ratio	1.52	0.72	0.54	0.96	0.57	0.16	0.72	0.99	0.18	0.72	1.14	0.18
Control Delay	276.7	65.1	34.6	123.6	51.4	0.2	61.2	58.6	3.5	58.9	105.3	0.2
Queue Delay	0.0	0.0	0.0	0.0	0.0	0.0	0.0	0.0	0.0	0.0	0.0	0.0
Total Delay	276.7	65.1	34.6	123.6	51.4	0.2	61.2	58.6	3.5	58.9	105.3	0.2
LOS	F	E	C	F	D	A	E	E	A	E	F	A
Approach Delay		136.2			49.0			56.1			88.9	
Approach LOS		F			D			E			F	

Intersection Summary

Cycle Length: 130  
 Actuated Cycle Length: 130  
 Offset: 0 (0%), Referenced to phase 2:NBT and 6:SBT, Start of Green  
 Natural Cycle: 145  
 Control Type: Actuated-Coordinated  
 Maximum v/c Ratio: 1.52  
 Intersection Signal Delay: 83.4  
 Intersection LOS: F  
 Intersection Capacity Utilization 92.2%  
 ICU Level of Service F  
 Analysis Period (min) 15

Splits and Phases: 3: Parker Rd & Lincoln Ave

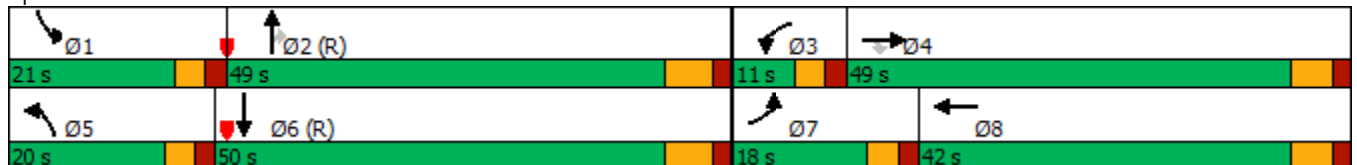

Queues  
3: Parker Rd & Lincoln Ave

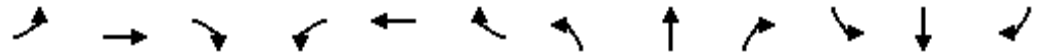

Lane Group	EBL	EBT	EBR	WBL	WBT	WBR	NBL	NBT	NBR	SBL	SBT	SBR
Lane Group Flow (vph)	522	592	307	152	361	250	367	1903	128	416	2303	283
v/c Ratio	1.52	0.72	0.54	0.96	0.57	0.16	0.72	0.99	0.18	0.72	1.14	0.18
Control Delay	276.7	65.1	34.6	123.6	51.4	0.2	61.2	58.6	3.5	58.9	105.3	0.2
Queue Delay	0.0	0.0	0.0	0.0	0.0	0.0	0.0	0.0	0.0	0.0	0.0	0.0
Total Delay	276.7	65.1	34.6	123.6	51.4	0.2	61.2	58.6	3.5	58.9	105.3	0.2
Queue Length 50th (ft)	~324	272	168	67	147	0	152	~603	0	171	~844	0
Queue Length 95th (ft)	m#309	m260	m164	#138	184	0	208	#783	30	234	#1023	0
Internal Link Dist (ft)		484			535			707			688	
Turn Bay Length (ft)	275			200			500			400		
Base Capacity (vph)	343	1170	696	158	980	1583	511	1923	692	578	2023	1583
Starvation Cap Reductn	0	0	0	0	0	0	0	0	0	0	0	0
Spillback Cap Reductn	0	0	0	0	0	0	0	0	0	0	0	0
Storage Cap Reductn	0	0	0	0	0	0	0	0	0	0	0	0
Reduced v/c Ratio	1.52	0.51	0.44	0.96	0.37	0.16	0.72	0.99	0.18	0.72	1.14	0.18

Intersection Summary

- ~ Volume exceeds capacity, queue is theoretically infinite.  
Queue shown is maximum after two cycles.
- # 95th percentile volume exceeds capacity, queue may be longer.  
Queue shown is maximum after two cycles.
- m Volume for 95th percentile queue is metered by upstream signal.

HCM 6th Signalized Intersection Summary  
3: Parker Rd & Lincoln Ave

Lincoln & Dransfeldt

09/27/2020

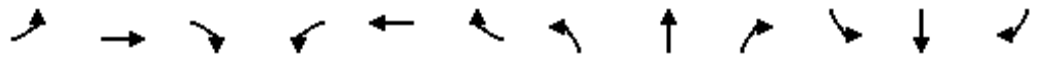

Movement	EBL	EBT	EBR	WBL	WBT	WBR	NBL	NBT	NBR	SBL	SBT	SBR
Lane Configurations	↖↗	↑↑	↖	↖↗	↑↑	↖	↖↗	↑↑↑	↖	↖↗	↑↑↑	↖
Traffic Volume (veh/h)	480	545	282	140	332	230	338	1751	118	383	2119	260
Future Volume (veh/h)	480	545	282	140	332	230	338	1751	118	383	2119	260
Initial Q (Qb), veh	0	0	0	0	0	0	0	0	0	0	0	0
Ped-Bike Adj(A_pbT)	1.00		1.00	1.00		1.00	1.00		1.00	1.00		1.00
Parking Bus, Adj	1.00	1.00	1.00	1.00	1.00	1.00	1.00	1.00	1.00	1.00	1.00	1.00
Work Zone On Approach		No			No			No			No	
Adj Sat Flow, veh/h/ln	1870	1870	1870	1870	1870	1870	1870	1870	1870	1870	1870	1870
Adj Flow Rate, veh/h	522	592	0	152	361	0	367	1903	0	416	2303	0
Peak Hour Factor	0.92	0.92	0.92	0.92	0.92	0.92	0.92	0.92	0.92	0.92	0.92	0.92
Percent Heavy Veh, %	2	2	2	2	2	2	2	2	2	2	2	2
Cap, veh/h	346	746		159	554		399	2287		425	2326	
Arrive On Green	0.03	0.07	0.00	0.05	0.16	0.00	0.12	0.45	0.00	0.12	0.46	0.00
Sat Flow, veh/h	3456	3554	1585	3456	3554	1585	3456	5106	1585	3456	5106	1585
Grp Volume(v), veh/h	522	592	0	152	361	0	367	1903	0	416	2303	0
Grp Sat Flow(s),veh/h/ln	1728	1777	1585	1728	1777	1585	1728	1702	1585	1728	1702	1585
Q Serve(g_s), s	13.0	21.3	0.0	5.7	12.4	0.0	13.7	42.6	0.0	15.6	58.1	0.0
Cycle Q Clear(g_c), s	13.0	21.3	0.0	5.7	12.4	0.0	13.7	42.6	0.0	15.6	58.1	0.0
Prop In Lane	1.00		1.00	1.00		1.00	1.00		1.00	1.00		1.00
Lane Grp Cap(c), veh/h	346	746		159	554		399	2287		425	2326	
V/C Ratio(X)	1.51	0.79		0.95	0.65		0.92	0.83		0.98	0.99	
Avail Cap(c_a), veh/h	346	1175		159	984		399	2287		425	2326	
HCM Platoon Ratio	0.33	0.33	0.33	1.00	1.00	1.00	1.00	1.00	1.00	1.00	1.00	1.00
Upstream Filter(I)	1.00	1.00	0.00	1.00	1.00	0.00	1.00	1.00	0.00	1.00	1.00	0.00
Uniform Delay (d), s/veh	62.9	57.7	0.0	61.9	51.5	0.0	56.9	31.6	0.0	56.8	35.1	0.0
Incr Delay (d2), s/veh	244.2	2.0	0.0	57.2	1.3	0.0	26.3	3.7	0.0	37.8	16.5	0.0
Initial Q Delay(d3),s/veh	0.0	0.0	0.0	0.0	0.0	0.0	0.0	0.0	0.0	0.0	0.0	0.0
%ile BackOfQ(95%),veh/ln	28.3	15.7	0.0	6.8	9.5	0.0	11.9	25.0	0.0	14.0	35.5	0.0
Unsig. Movement Delay, s/veh												
LnGrp Delay(d),s/veh	307.1	59.8	0.0	119.1	52.8	0.0	83.2	35.3	0.0	94.6	51.6	0.0
LnGrp LOS	F	E		F	D		F	D		F	D	
Approach Vol, veh/h		1114	A		513	A		2270	A		2719	A
Approach Delay, s/veh		175.7			72.5			43.1			58.1	
Approach LOS		F			E			D			E	
Timer - Assigned Phs	1	2	3	4	5	6	7	8				
Phs Duration (G+Y+Rc), s	21.0	64.7	11.0	33.3	20.0	65.7	18.0	26.3				
Change Period (Y+Rc), s	5.0	6.5	5.0	6.0	5.0	6.5	5.0	6.0				
Max Green Setting (Gmax), s	16.0	42.5	6.0	43.0	15.0	43.5	13.0	36.0				
Max Q Clear Time (g_c+I1), s	17.6	44.6	7.7	23.3	15.7	60.1	15.0	14.4				
Green Ext Time (p_c), s	0.0	0.0	0.0	3.9	0.0	0.0	0.0	2.3				

Intersection Summary

HCM 6th Ctrl Delay	73.9
HCM 6th LOS	E

Notes

Unsignalized Delay for [NBR, EBR, WBR, SBR] is excluded from calculations of the approach delay and intersection delay.

Lanes and Geometrics  
4: Dransfeldt Rd & Lowe's Access



Lane Group	EBL	EBR	NBL	NBT	SBT	SBR
Lane Configurations						
Ideal Flow (vphp)	1900	1900	1900	1900	1900	1900
Lane Width (ft)	12	12	12	12	12	12
Grade (%)	0%			0%	0%	
Storage Length (ft)	0	0	125			0
Storage Lanes	1	0	1			0
Taper Length (ft)	25		25			
Lane Util. Factor	1.00	1.00	1.00	0.95	1.00	1.00
Ped Bike Factor						
Frt	0.940				0.980	
Flt Protected	0.973		0.950			
Satd. Flow (prot)	1704	0	1770	3539	1825	0
Flt Permitted	0.973		0.950			
Satd. Flow (perm)	1704	0	1770	3539	1825	0
Link Speed (mph)	30			30	30	
Link Distance (ft)	400			232	422	
Travel Time (s)	9.1			5.3	9.6	

Intersection Summary

Area Type: Other

Intersection						
Int Delay, s/veh	1.1					
Movement	EBL	EBR	NBL	NBT	SBT	SBR
Lane Configurations	W		W	↑↑	↑	
Traffic Vol, veh/h	41	33	15	596	329	57
Future Vol, veh/h	41	33	15	596	329	57
Conflicting Peds, #/hr	0	0	0	0	0	0
Sign Control	Stop	Stop	Free	Free	Free	Free
RT Channelized	-	None	-	None	-	None
Storage Length	0	-	125	-	-	-
Veh in Median Storage, #	0	-	-	0	0	-
Grade, %	0	-	-	0	0	-
Peak Hour Factor	92	92	92	92	92	92
Heavy Vehicles, %	2	2	2	2	2	2
Mvmt Flow	45	36	16	648	358	62





























Major/Minor	Minor2	Major1	Major2			
Conflicting Flow All	745	389	420	0	-	0
Stage 1	389	-	-	-	-	-
Stage 2	356	-	-	-	-	-
Critical Hdwy	6.63	6.23	4.13	-	-	-
Critical Hdwy Stg 1	5.43	-	-	-	-	-
Critical Hdwy Stg 2	5.83	-	-	-	-	-
Follow-up Hdwy	3.519	3.319	2.219	-	-	-
Pot Cap-1 Maneuver	365	658	1137	-	-	-
Stage 1	684	-	-	-	-	-
Stage 2	681	-	-	-	-	-
Platoon blocked, %				-	-	-
Mov Cap-1 Maneuver	360	658	1137	-	-	-
Mov Cap-2 Maneuver	360	-	-	-	-	-
Stage 1	674	-	-	-	-	-
Stage 2	681	-	-	-	-	-

Approach	EB	NB	SB
HCM Control Delay, s	14.7	0.2	0
HCM LOS	B		

Minor Lane/Major Mvmt	NBL	NBT	EBLn1	SBT	SBR
Capacity (veh/h)	1137	-	451	-	-
HCM Lane V/C Ratio	0.014	-	0.178	-	-
HCM Control Delay (s)	8.2	-	14.7	-	-
HCM Lane LOS	A	-	B	-	-
HCM 95th %tile Q(veh)	0	-	0.6	-	-

Lanes and Geometrics  
1: Dransfeldt Rd & Lincoln Ave

Lincoln & Dransfeldt  
09/27/2020

												
Lane Group	EBL	EBT	EBR	WBL	WBT	WBR	NBL	NBT	NBR	SBL	SBT	SBR
Lane Configurations		 			 			 			 	
Ideal Flow (vphpl)	1900	1900	1900	1900	1900	1900	1900	1900	1900	1900	1900	1900
Lane Width (ft)	12	12	12	12	12	12	12	12	12	12	12	12
Grade (%)		0%			0%			0%			0%	
Storage Length (ft)	200		0	330		0	300		0	100		0
Storage Lanes	1		1	1		1	1		1	1		1
Taper Length (ft)	25			25			25			25		
Lane Util. Factor	1.00	0.95	1.00	1.00	0.95	1.00	0.95	0.95	1.00	1.00	1.00	1.00
Ped Bike Factor			0.850			0.850			0.850			0.850
Flt Protected	0.950			0.950			0.950	0.978		0.950		
Satd. Flow (prot)	1770	3539	1583	1770	3539	1583	1681	1731	1583	1770	1863	1583
Flt Permitted	0.110			0.108			0.950	0.978		0.950		
Satd. Flow (perm)	205	3539	1583	201	3539	1583	1681	1731	1583	1770	1863	1583
Right Turn on Red			Yes			Yes			Yes			Yes
Satd. Flow (RTOR)			159			117			164			164
Link Speed (mph)		30			30			30			30	
Link Distance (ft)		427			552			422			289	
Travel Time (s)		9.7			12.5			9.6			6.6	

Intersection Summary

Area Type: Other

Timings  
1: Dransfeldt Rd & Lincoln Ave

Lane Group	EBL	EBT	EBR	WBL	WBT	WBR	NBL	NBT	NBR	SBL	SBT	SBR
Lane Configurations												
Traffic Volume (vph)	36	760	144	177	1142	4	122	47	151	3	70	46
Future Volume (vph)	36	760	144	177	1142	4	122	47	151	3	70	46
Turn Type	pm+pt	NA	Perm	pm+pt	NA	Perm	Split	NA	Perm	Split	NA	Perm
Protected Phases	7	4		3	8		2	2		6	6	
Permitted Phases	4		4	8		8			2			6
Detector Phase	7	4	4	3	8	8	2	2	2	6	6	6
Switch Phase												
Minimum Initial (s)	3.0	10.0	10.0	4.0	10.0	10.0	5.0	5.0	5.0	5.0	5.0	5.0
Minimum Split (s)	10.0	40.0	40.0	9.5	35.0	35.0	35.0	35.0	35.0	35.0	35.0	35.0
Total Split (s)	10.0	40.0	40.0	21.0	51.0	51.0	35.0	35.0	35.0	34.0	34.0	34.0
Total Split (%)	7.7%	30.8%	30.8%	16.2%	39.2%	39.2%	26.9%	26.9%	26.9%	26.2%	26.2%	26.2%
Yellow Time (s)	4.0	4.0	4.0	3.0	3.0	3.0	3.5	3.5	3.5	3.5	3.5	3.5
All-Red Time (s)	2.0	2.0	2.0	2.0	2.0	2.0	2.0	2.0	2.0	2.0	2.0	2.0
Lost Time Adjust (s)	0.0	0.0	0.0	0.0	0.0	0.0	0.0	0.0	0.0	0.0	0.0	0.0
Total Lost Time (s)	6.0	6.0	6.0	5.0	5.0	5.0	5.5	5.5	5.5	5.5	5.5	5.5
Lead/Lag	Lead	Lag	Lag	Lead	Lag	Lag						
Lead-Lag Optimize?	Yes	Yes	Yes	Yes	Yes	Yes						
Recall Mode	None	None	None	None	None	None	C-Max	C-Max	C-Max	Max	Max	Max
Act Effct Green (s)	39.1	35.1	35.1	55.0	47.0	47.0	30.5	30.5	30.5	28.5	28.5	28.5
Actuated g/C Ratio	0.30	0.27	0.27	0.42	0.36	0.36	0.23	0.23	0.23	0.22	0.22	0.22
v/c Ratio	0.36	0.86	0.29	0.76	0.97	0.01	0.23	0.23	0.33	0.01	0.19	0.11
Control Delay	32.7	55.9	6.8	68.4	51.4	0.0	42.7	42.7	7.8	40.0	42.8	0.4
Queue Delay	0.0	0.0	0.0	0.0	0.0	0.0	0.0	0.0	0.0	0.0	0.0	0.0
Total Delay	32.7	55.9	6.8	68.4	51.4	0.0	42.7	42.7	7.8	40.0	42.8	0.4
LOS	C	E	A	E	D	A	D	D	A	D	D	A
Approach Delay		47.5			53.6			26.3			26.3	
Approach LOS		D			D			C			C	

Intersection Summary

Cycle Length: 130  
 Actuated Cycle Length: 130  
 Offset: 0 (0%), Referenced to phase 2:NBTL, Start of Green  
 Natural Cycle: 120  
 Control Type: Actuated-Coordinated  
 Maximum v/c Ratio: 0.97  
 Intersection Signal Delay: 47.0  
 Intersection LOS: D  
 Intersection Capacity Utilization 59.9%  
 ICU Level of Service B  
 Analysis Period (min) 15

Splits and Phases: 1: Dransfeldt Rd & Lincoln Ave

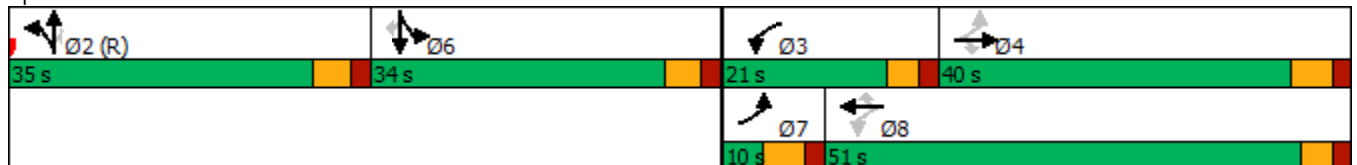

Queues

1: Dransfeldt Rd & Lincoln Ave

09/27/2020

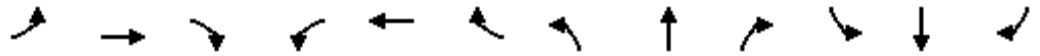

Lane Group	EBL	EBT	EBR	WBL	WBT	WBR	NBL	NBT	NBR	SBL	SBT	SBR
Lane Group Flow (vph)	39	826	157	192	1241	4	90	94	164	3	76	50
v/c Ratio	0.36	0.86	0.29	0.76	0.97	0.01	0.23	0.23	0.33	0.01	0.19	0.11
Control Delay	32.7	55.9	6.8	68.4	51.4	0.0	42.7	42.7	7.8	40.0	42.8	0.4
Queue Delay	0.0	0.0	0.0	0.0	0.0	0.0	0.0	0.0	0.0	0.0	0.0	0.0
Total Delay	32.7	55.9	6.8	68.4	51.4	0.0	42.7	42.7	7.8	40.0	42.8	0.4
Queue Length 50th (ft)	19	350	0	121	563	0	65	68	0	2	53	0
Queue Length 95th (ft)	42	#465	53	m184	#696	m0	117	122	58	11	97	0
Internal Link Dist (ft)		347			472			342			209	
Turn Bay Length (ft)	200			330			300			100		
Base Capacity (vph)	109	956	543	278	1280	647	393	405	496	388	408	475
Starvation Cap Reductn	0	0	0	0	0	0	0	0	0	0	0	0
Spillback Cap Reductn	0	0	0	0	0	0	0	0	0	0	0	0
Storage Cap Reductn	0	0	0	0	0	0	0	0	0	0	0	0
Reduced v/c Ratio	0.36	0.86	0.29	0.69	0.97	0.01	0.23	0.23	0.33	0.01	0.19	0.11

Intersection Summary

- # 95th percentile volume exceeds capacity, queue may be longer.  
Queue shown is maximum after two cycles.
- m Volume for 95th percentile queue is metered by upstream signal.

HCM 6th Signalized Intersection Summary  
1: Dransfeldt Rd & Lincoln Ave

Lincoln & Dransfeldt  
09/27/2020

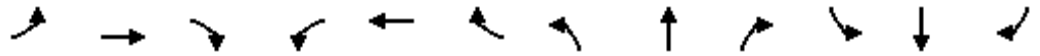

Movement	EBL	EBT	EBR	WBL	WBT	WBR	NBL	NBT	NBR	SBL	SBT	SBR
Lane Configurations												
Traffic Volume (veh/h)	36	760	144	177	1142	4	122	47	151	3	70	46
Future Volume (veh/h)	36	760	144	177	1142	4	122	47	151	3	70	46
Initial Q (Qb), veh	0	0	0	0	0	0	0	0	0	0	0	0
Ped-Bike Adj(A_pbT)	1.00		1.00	1.00		1.00	1.00		1.00	1.00		1.00
Parking Bus, Adj	1.00	1.00	1.00	1.00	1.00	1.00	1.00	1.00	1.00	1.00	1.00	1.00
Work Zone On Approach		No			No			No			No	
Adj Sat Flow, veh/h/ln	1870	1870	1870	1870	1870	1870	1870	1870	1870	1870	1870	1870
Adj Flow Rate, veh/h	39	826	157	192	1241	4	92	108	164	3	76	50
Peak Hour Factor	0.92	0.92	0.92	0.92	0.92	0.92	0.92	0.92	0.92	0.92	0.92	0.92
Percent Heavy Veh, %	2	2	2	2	2	2	2	2	2	2	2	2
Cap, veh/h	100	1049	468	261	1257	561	410	430	365	391	410	347
Arrive On Green	0.02	0.30	0.30	0.09	0.35	0.35	0.23	0.23	0.23	0.22	0.22	0.22
Sat Flow, veh/h	1781	3554	1585	1781	3554	1585	1781	1870	1585	1781	1870	1585
Grp Volume(v), veh/h	39	826	157	192	1241	4	92	108	164	3	76	50
Grp Sat Flow(s),veh/h/ln	1781	1777	1585	1781	1777	1585	1781	1870	1585	1781	1870	1585
Q Serve(g_s), s	2.0	27.7	10.1	9.4	45.1	0.2	5.5	6.1	11.6	0.2	4.3	3.3
Cycle Q Clear(g_c), s	2.0	27.7	10.1	9.4	45.1	0.2	5.5	6.1	11.6	0.2	4.3	3.3
Prop In Lane	1.00		1.00	1.00		1.00	1.00		1.00	1.00		1.00
Lane Grp Cap(c), veh/h	100	1049	468	261	1257	561	410	430	365	391	410	347
V/C Ratio(X)	0.39	0.79	0.34	0.73	0.99	0.01	0.22	0.25	0.45	0.01	0.19	0.14
Avail Cap(c_a), veh/h	113	1049	468	322	1257	561	410	430	365	391	410	347
HCM Platoon Ratio	1.00	1.00	1.00	1.00	1.00	1.00	1.00	1.00	1.00	1.00	1.00	1.00
Upstream Filter(I)	1.00	1.00	1.00	1.00	1.00	1.00	1.00	1.00	1.00	1.00	1.00	1.00
Uniform Delay (d), s/veh	36.5	42.1	35.8	31.2	41.7	27.2	40.6	40.9	43.0	39.7	41.3	40.9
Incr Delay (d2), s/veh	2.5	4.1	0.4	6.6	22.2	0.0	1.3	1.4	4.0	0.0	1.0	0.9
Initial Q Delay(d3),s/veh	0.0	0.0	0.0	0.0	0.0	0.0	0.0	0.0	0.0	0.0	0.0	0.0
%ile BackOfQ(95%),veh/ln	1.7	18.6	7.2	8.0	31.3	0.1	4.6	5.4	8.6	0.1	3.8	2.5
Unsig. Movement Delay, s/veh												
LnGrp Delay(d),s/veh	39.0	46.1	36.2	37.8	63.9	27.2	41.9	42.3	46.9	39.7	42.3	41.8
LnGrp LOS	D	D	D	D	E	C	D	D	D	D	D	D
Approach Vol, veh/h		1022			1437			364			129	
Approach Delay, s/veh		44.3			60.3			44.3			42.0	
Approach LOS		D			E			D			D	
Timer - Assigned Phs		2	3	4		6	7	8				
Phs Duration (G+Y+Rc), s		35.4	16.6	44.4		34.0	9.0	52.0				
Change Period (Y+Rc), s		5.5	5.0	6.0		5.5	6.0	* 6				
Max Green Setting (Gmax), s		29.5	16.0	34.0		28.5	4.0	* 46				
Max Q Clear Time (g_c+I1), s		13.6	11.4	29.7		6.3	4.0	47.1				
Green Ext Time (p_c), s		1.2	0.2	2.3		0.5	0.0	0.0				

Intersection Summary

HCM 6th Ctrl Delay	52.0
HCM 6th LOS	D

Notes

- User approved pedestrian interval to be less than phase max green.
- User approved volume balancing among the lanes for turning movement.
- \* HCM 6th computational engine requires equal clearance times for the phases crossing the barrier.

Lanes and Geometrics  
2: Walgreens Access & Lincoln Ave

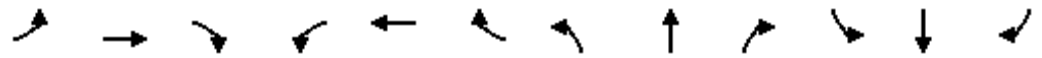

Lane Group	EBL	EBT	EBR	WBL	WBT	WBR	NBL	NBT	NBR	SBL	SBT	SBR
Lane Configurations		↑↑↑			↑↑↑				↑			↑
Ideal Flow (vphpl)	1900	1900	1900	1900	1900	1900	1900	1900	1900	1900	1900	1900
Lane Width (ft)	12	12	12	12	12	12	12	12	12	12	12	12
Grade (%)		0%			0%			0%			0%	
Storage Length (ft)	0		0	0		0	0		0	0		0
Storage Lanes	0		0	0		0	0		1	0		1
Taper Length (ft)	25			25			25			25		
Lane Util. Factor	1.00	0.91	0.91	1.00	0.91	0.91	1.00	1.00	1.00	1.00	1.00	1.00
Ped Bike Factor		0.996			0.996				0.865			0.865
Flt Protected												
Satd. Flow (prot)	0	5065	0	0	5065	0	0	0	1611	0	0	1611
Flt Permitted												
Satd. Flow (perm)	0	5065	0	0	5065	0	0	0	1611	0	0	1611
Link Speed (mph)		30			30			30				30
Link Distance (ft)		552			564			131				173
Travel Time (s)		12.5			12.8			3.0				3.9

Intersection Summary

Area Type: Other

Intersection												
Int Delay, s/veh	0.4											
Movement	EBL	EBT	EBR	WBL	WBT	WBR	NBL	NBT	NBR	SBL	SBT	SBR
Lane Configurations	↑↑↑			↑↑↑					↑			↑
Traffic Vol, veh/h	0	890	23	0	1289	35	0	0	15	0	0	34
Future Vol, veh/h	0	890	23	0	1289	35	0	0	15	0	0	34
Conflicting Peds, #/hr	0	0	0	0	0	0	0	0	0	0	0	0
Sign Control	Free	Free	Free	Free	Free	Free	Stop	Stop	Stop	Stop	Stop	Stop
RT Channelized	-	-	None	-	-	None	-	-	None	-	-	None
Storage Length	-	-	-	-	-	-	-	-	0	-	-	0
Veh in Median Storage, #	-	0	-	-	0	-	-	0	-	-	0	-
Grade, %	-	0	-	-	0	-	-	0	-	-	0	-
Peak Hour Factor	92	92	92	92	92	92	92	92	92	92	92	92
Heavy Vehicles, %	2	2	2	2	2	2	2	2	2	2	2	2
Mvmt Flow	0	967	25	0	1401	38	0	0	16	0	0	37

Major/Minor	Major1		Major2		Minor1		Minor2					
Conflicting Flow All	-	0	0	-	-	0	-	-	496	-	-	720
Stage 1	-	-	-	-	-	-	-	-	-	-	-	-
Stage 2	-	-	-	-	-	-	-	-	-	-	-	-
Critical Hdwy	-	-	-	-	-	-	-	-	7.14	-	-	7.14
Critical Hdwy Stg 1	-	-	-	-	-	-	-	-	-	-	-	-
Critical Hdwy Stg 2	-	-	-	-	-	-	-	-	-	-	-	-
Follow-up Hdwy	-	-	-	-	-	-	-	-	3.92	-	-	3.92
Pot Cap-1 Maneuver	0	-	-	0	-	-	0	0	444	0	0	318
Stage 1	0	-	-	0	-	-	0	0	-	0	0	-
Stage 2	0	-	-	0	-	-	0	0	-	0	0	-
Platoon blocked, %	-	-	-	-	-	-	-	-	-	-	-	-
Mov Cap-1 Maneuver	-	-	-	-	-	-	-	-	444	-	-	318
Mov Cap-2 Maneuver	-	-	-	-	-	-	-	-	-	-	-	-
Stage 1	-	-	-	-	-	-	-	-	-	-	-	-
Stage 2	-	-	-	-	-	-	-	-	-	-	-	-

Approach	EB	WB	NB	SB
HCM Control Delay, s	0	0	13.4	17.8
HCM LOS			B	C

Minor Lane/Major Mvmt	NBLn1	EBT	EBR	WBT	WBR	SBLn1
Capacity (veh/h)	444	-	-	-	-	318
HCM Lane V/C Ratio	0.037	-	-	-	-	0.116
HCM Control Delay (s)	13.4	-	-	-	-	17.8
HCM Lane LOS	B	-	-	-	-	C
HCM 95th %tile Q(veh)	0.1	-	-	-	-	0.4

Lanes and Geometrics  
3: Parker Rd & Lincoln Ave

Lincoln & Dransfeldt

09/27/2020



Lane Group	EBL	EBT	EBR	WBL	WBT	WBR	NBL	NBT	NBR	SBL	SBT	SBR
Lane Configurations												
Ideal Flow (vphpl)	1900	1900	1900	1900	1900	1900	1900	1900	1900	1900	1900	1900
Lane Width (ft)	12	12	12	12	12	12	12	12	12	12	12	12
Grade (%)	0%		0%				0%			0%		
Storage Length (ft)	275		0	200		0	500		0	400		0
Storage Lanes	2		1	2		1	2		1	2		1
Taper Length (ft)	25			25			25			25		
Lane Util. Factor	0.97	0.95	1.00	0.97	0.95	1.00	0.97	0.91	1.00	0.97	0.91	1.00
Ped Bike Factor	0.850			0.850			0.850			0.850		
Flt Protected	0.950			0.950			0.950			0.950		
Satd. Flow (prot)	3433	3539	1583	3433	3539	1583	3433	5085	1583	3433	5085	1583
Flt Permitted	0.950			0.950			0.950			0.950		
Satd. Flow (perm)	3433	3539	1583	3433	3539	1583	3433	5085	1583	3433	5085	1583
Right Turn on Red			Yes			Yes			Yes			Yes
Satd. Flow (RTOR)			260			359			151			206
Link Speed (mph)		30			30			30			30	
Link Distance (ft)		564			615			787			768	
Travel Time (s)		12.8			14.0			17.9			17.5	

Intersection Summary

Area Type: Other

Timings  
3: Parker Rd & Lincoln Ave

Lane Group	EBL	EBT	EBR	WBL	WBT	WBR	NBL	NBT	NBR	SBL	SBT	SBR
Lane Configurations												
Traffic Volume (vph)	263	403	239	160	645	400	393	1586	94	221	1329	286
Future Volume (vph)	263	403	239	160	645	400	393	1586	94	221	1329	286
Turn Type	Prot	NA	Perm	Prot	NA	Free	Prot	NA	Perm	Prot	NA	Free
Protected Phases	7	4		3	8		5	2		1	6	
Permitted Phases			4			Free			2			Free
Detector Phase	7	4	4	3	8		5	2	2	1	6	
Switch Phase												
Minimum Initial (s)	5.0	5.0	5.0	5.0	5.0		5.0	5.0	5.0	5.0	5.0	
Minimum Split (s)	10.0	35.0	35.0	10.0	35.0		15.0	30.5	30.5	10.0	30.5	
Total Split (s)	18.0	49.0	49.0	11.0	42.0		20.0	49.0	49.0	21.0	50.0	
Total Split (%)	13.8%	37.7%	37.7%	8.5%	32.3%		15.4%	37.7%	37.7%	16.2%	38.5%	
Yellow Time (s)	3.0	4.0	4.0	3.0	4.0		3.0	4.5	4.5	3.0	4.5	
All-Red Time (s)	2.0	2.0	2.0	2.0	2.0		2.0	2.0	2.0	2.0	2.0	
Lost Time Adjust (s)	0.0	0.0	0.0	0.0	0.0		0.0	0.0	0.0	0.0	0.0	
Total Lost Time (s)	5.0	6.0	6.0	5.0	6.0		5.0	6.5	6.5	5.0	6.5	
Lead/Lag	Lead	Lag	Lag	Lead	Lag		Lead	Lag	Lag	Lead	Lag	
Lead-Lag Optimize?	Yes	Yes	Yes	Yes	Yes		Yes	Yes	Yes	Yes	Yes	
Recall Mode	None	None	None	None	None		None	C-Max	C-Max	None	C-Max	
Act Effct Green (s)	12.9	38.6	38.6	6.0	31.7	130.0	19.4	49.0	49.0	13.9	43.5	130.0
Actuated g/C Ratio	0.10	0.30	0.30	0.05	0.24	1.00	0.15	0.38	0.38	0.11	0.33	1.00
v/c Ratio	0.84	0.42	0.40	1.10	0.81	0.27	0.84	0.90	0.15	0.65	0.85	0.20
Control Delay	70.0	64.2	34.6	157.0	54.3	0.4	69.1	46.3	1.6	64.3	46.0	0.3
Queue Delay	0.0	0.0	0.0	0.0	0.0	0.0	0.0	0.0	0.0	0.0	0.0	0.0
Total Delay	70.0	64.2	34.6	157.0	54.3	0.4	69.1	46.3	1.6	64.3	46.0	0.3
LOS	E	E	C	F	D	A	E	D	A	E	D	A
Approach Delay		58.0			50.0			48.6			41.1	
Approach LOS		E			D			D			D	

Intersection Summary

Cycle Length: 130  
 Actuated Cycle Length: 130  
 Offset: 0 (0%), Referenced to phase 2:NBT and 6:SBT, Start of Green  
 Natural Cycle: 95  
 Control Type: Actuated-Coordinated  
 Maximum v/c Ratio: 1.10  
 Intersection Signal Delay: 48.0  
 Intersection LOS: D  
 Intersection Capacity Utilization 81.0%  
 ICU Level of Service D  
 Analysis Period (min) 15

Splits and Phases: 3: Parker Rd & Lincoln Ave

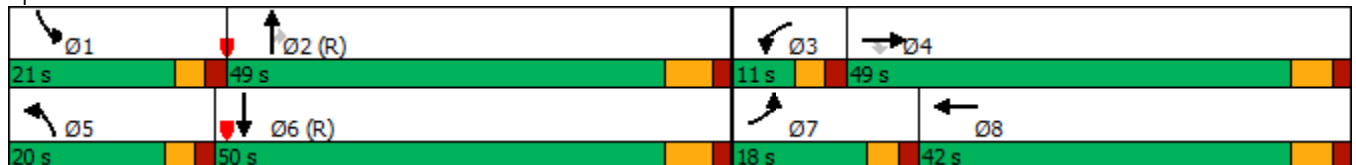

Queues  
3: Parker Rd & Lincoln Ave

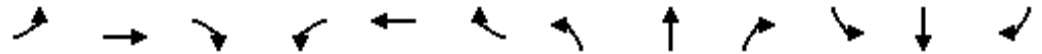































Lane Group	EBL	EBT	EBR	WBL	WBT	WBR	NBL	NBT	NBR	SBL	SBT	SBR
Lane Group Flow (vph)	286	438	260	174	701	435	427	1724	102	240	1445	311
v/c Ratio	0.84	0.42	0.40	1.10	0.81	0.27	0.84	0.90	0.15	0.65	0.85	0.20
Control Delay	70.0	64.2	34.6	157.0	54.3	0.4	69.1	46.3	1.6	64.3	46.0	0.3
Queue Delay	0.0	0.0	0.0	0.0	0.0	0.0	0.0	0.0	0.0	0.0	0.0	0.0
Total Delay	70.0	64.2	34.6	157.0	54.3	0.4	69.1	46.3	1.6	64.3	46.0	0.3
Queue Length 50th (ft)	131	199	142	-85	292	0	184	505	0	101	413	0
Queue Length 95th (ft)	m158	m237	m192	#162	353	0	#312	#669	11	144	477	0
Internal Link Dist (ft)		484			535			707			688	
Turn Bay Length (ft)	275			200			500			400		
Base Capacity (vph)	343	1170	697	158	980	1583	511	1917	691	422	1703	1583
Starvation Cap Reductn	0	0	0	0	0	0	0	0	0	0	0	0
Spillback Cap Reductn	0	0	0	0	0	0	0	0	0	0	0	0
Storage Cap Reductn	0	0	0	0	0	0	0	0	0	0	0	0
Reduced v/c Ratio	0.83	0.37	0.37	1.10	0.72	0.27	0.84	0.90	0.15	0.57	0.85	0.20

Intersection Summary

- ~ Volume exceeds capacity, queue is theoretically infinite.  
Queue shown is maximum after two cycles.
- # 95th percentile volume exceeds capacity, queue may be longer.  
Queue shown is maximum after two cycles.
- m Volume for 95th percentile queue is metered by upstream signal.

HCM 6th Signalized Intersection Summary  
3: Parker Rd & Lincoln Ave

Lincoln & Dransfeldt  
09/27/2020

												
Movement	EBL	EBT	EBR	WBL	WBT	WBR	NBL	NBT	NBR	SBL	SBT	SBR
Lane Configurations	 	 		 	 		 	  		  		
Traffic Volume (veh/h)	263	403	239	160	645	400	393	1586	94	221	1329	286
Future Volume (veh/h)	263	403	239	160	645	400	393	1586	94	221	1329	286
Initial Q (Qb), veh	0	0	0	0	0	0	0	0	0	0	0	0
Ped-Bike Adj(A_pbT)	1.00		1.00	1.00		1.00	1.00		1.00	1.00		1.00
Parking Bus, Adj	1.00	1.00	1.00	1.00	1.00	1.00	1.00	1.00	1.00	1.00	1.00	1.00
Work Zone On Approach		No			No			No			No	
Adj Sat Flow, veh/h/ln	1870	1870	1870	1870	1870	1870	1870	1870	1870	1870	1870	1870
Adj Flow Rate, veh/h	286	438	0	174	701	0	427	1724	0	240	1445	0
Peak Hour Factor	0.92	0.92	0.92	0.92	0.92	0.92	0.92	0.92	0.92	0.92	0.92	0.92
Percent Heavy Veh, %	2	2	2	2	2	2	2	2	2	2	2	2
Cap, veh/h	339	1001		159	817		399	2108		298	1960	
Arrive On Green	0.03	0.09	0.00	0.05	0.23	0.00	0.12	0.41	0.00	0.09	0.38	0.00
Sat Flow, veh/h	3456	3554	1585	3456	3554	1585	3456	5106	1585	3456	5106	1585
Grp Volume(v), veh/h	286	438	0	174	701	0	427	1724	0	240	1445	0
Grp Sat Flow(s),veh/h/ln	1728	1777	1585	1728	1777	1585	1728	1702	1585	1728	1702	1585
Q Serve(g_s), s	10.7	15.2	0.0	6.0	24.6	0.0	15.0	38.9	0.0	8.9	31.6	0.0
Cycle Q Clear(g_c), s	10.7	15.2	0.0	6.0	24.6	0.0	15.0	38.9	0.0	8.9	31.6	0.0
Prop In Lane	1.00		1.00	1.00		1.00	1.00		1.00	1.00		1.00
Lane Grp Cap(c), veh/h	339	1001		159	817		399	2108		298	1960	
V/C Ratio(X)	0.84	0.44		1.09	0.86		1.07	0.82		0.80	0.74	
Avail Cap(c_a), veh/h	346	1175		159	984		399	2108		425	1960	
HCM Platoon Ratio	0.33	0.33	0.33	1.00	1.00	1.00	1.00	1.00	1.00	1.00	1.00	1.00
Upstream Filter(I)	1.00	1.00	0.00	1.00	1.00	0.00	1.00	1.00	0.00	1.00	1.00	0.00
Uniform Delay (d), s/veh	61.9	49.2	0.0	62.0	48.0	0.0	57.5	33.8	0.0	58.3	34.4	0.0
Incr Delay (d2), s/veh	17.0	0.3	0.0	97.7	6.6	0.0	65.2	3.7	0.0	7.3	2.5	0.0
Initial Q Delay(d3),s/veh	0.0	0.0	0.0	0.0	0.0	0.0	0.0	0.0	0.0	0.0	0.0	0.0
%ile BackOfQ(95%),veh/ln	9.7	11.7	0.0	8.6	17.2	0.0	15.8	23.3	0.0	7.5	19.5	0.0
Unsig. Movement Delay, s/veh												
LnGrp Delay(d),s/veh	78.9	49.5	0.0	159.7	54.7	0.0	122.7	37.5	0.0	65.6	36.9	0.0
LnGrp LOS	E	D		F	D		F	D		E	D	
Approach Vol, veh/h		724	A		875	A		2151	A		1685	A
Approach Delay, s/veh		61.1			75.6			54.4			41.0	
Approach LOS		E			E			D			D	
Timer - Assigned Phs	1	2	3	4	5	6	7	8				
Phs Duration (G+Y+Rc), s	16.2	60.2	11.0	42.6	20.0	56.4	17.7	35.9				
Change Period (Y+Rc), s	5.0	6.5	5.0	6.0	5.0	6.5	5.0	6.0				
Max Green Setting (Gmax), s	16.0	42.5	6.0	43.0	15.0	43.5	13.0	36.0				
Max Q Clear Time (g_c+I1), s	10.9	40.9	8.0	17.2	17.0	33.6	12.7	26.6				
Green Ext Time (p_c), s	0.4	1.4	0.0	3.0	0.0	6.6	0.0	3.3				

Intersection Summary

HCM 6th Ctrl Delay	54.6
HCM 6th LOS	D

Notes

Unsignalized Delay for [NBR, EBR, WBR, SBR] is excluded from calculations of the approach delay and intersection delay.

Lanes and Geometrics  
4: Dransfeldt Rd & Lowe's Access



Lane Group	EBL	EBR	NBL	NBT	SBT	SBR
Lane Configurations						
Ideal Flow (vphp)	1900	1900	1900	1900	1900	1900
Lane Width (ft)	12	12	12	12	12	12
Grade (%)	0%			0%	0%	
Storage Length (ft)	0	0	125			0
Storage Lanes	1	0	1			0
Taper Length (ft)	25		25			
Lane Util. Factor	1.00	1.00	1.00	0.95	1.00	1.00
Ped Bike Factor						
Frt	0.938				0.984	
Flt Protected	0.974		0.950			
Satd. Flow (prot)	1702	0	1770	3539	1833	0
Flt Permitted	0.974		0.950			
Satd. Flow (perm)	1702	0	1770	3539	1833	0
Link Speed (mph)	30			30	30	
Link Distance (ft)	400			232	422	
Travel Time (s)	9.1			5.3	9.6	

Intersection Summary

Area Type: Other

Intersection						
Int Delay, s/veh	1					
Movement	EBL	EBR	NBL	NBT	SBT	SBR
Lane Configurations						
Traffic Vol, veh/h	25	21	17	294	347	45
Future Vol, veh/h	25	21	17	294	347	45
Conflicting Peds, #/hr	0	0	0	0	0	0
Sign Control	Stop	Stop	Free	Free	Free	Free
RT Channelized	-	None	-	None	-	None
Storage Length	0	-	125	-	-	-
Veh in Median Storage, #	0	-	-	0	0	-
Grade, %	0	-	-	0	0	-
Peak Hour Factor	92	92	92	92	92	92
Heavy Vehicles, %	2	2	2	2	2	2
Mvmt Flow	27	23	18	320	377	49

Major/Minor	Minor2	Major1	Major2			
Conflicting Flow All	598	402	426	0	-	0
Stage 1	402	-	-	-	-	-
Stage 2	196	-	-	-	-	-
Critical Hdwy	6.63	6.23	4.13	-	-	-
Critical Hdwy Stg 1	5.43	-	-	-	-	-
Critical Hdwy Stg 2	5.83	-	-	-	-	-
Follow-up Hdwy	3.519	3.319	2.219	-	-	-
Pot Cap-1 Maneuver	449	647	1132	-	-	-
Stage 1	675	-	-	-	-	-
Stage 2	818	-	-	-	-	-
Platoon blocked, %				-	-	-
Mov Cap-1 Maneuver	442	647	1132	-	-	-
Mov Cap-2 Maneuver	442	-	-	-	-	-
Stage 1	664	-	-	-	-	-
Stage 2	818	-	-	-	-	-

Approach	EB	NB	SB
HCM Control Delay, s	12.7	0.5	0
HCM LOS	B		

Minor Lane/Major Mvmt	NBL	NBT	EBLn1	SBT	SBR
Capacity (veh/h)	1132	-	517	-	-
HCM Lane V/C Ratio	0.016	-	0.097	-	-
HCM Control Delay (s)	8.2	-	12.7	-	-
HCM Lane LOS	A	-	B	-	-
HCM 95th %tile Q(veh)	0.1	-	0.3	-	-

Lanes and Geometrics  
1: Dransfeldt Rd & Lincoln Ave

Lincoln & Dransfeldt  
09/27/2020

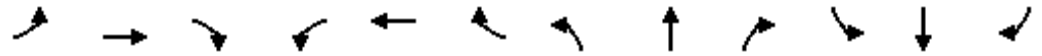

Lane Group	EBL	EBT	EBR	WBL	WBT	WBR	NBL	NBT	NBR	SBL	SBT	SBR
Lane Configurations												
Ideal Flow (vphpl)	1900	1900	1900	1900	1900	1900	1900	1900	1900	1900	1900	1900
Lane Width (ft)	12	12	12	12	12	12	12	12	12	12	12	12
Grade (%)		0%			0%			0%			0%	
Storage Length (ft)	200		0	330		0	300		0	100		0
Storage Lanes	1		1	1		1	1		1	1		1
Taper Length (ft)	25			25			25			25		
Lane Util. Factor	1.00	0.95	1.00	1.00	0.95	1.00	0.95	0.95	1.00	1.00	1.00	1.00
Ped Bike Factor			0.850			0.850			0.850			0.850
Flt Protected	0.950			0.950			0.950	0.986		0.950		
Satd. Flow (prot)	1770	3539	1583	1770	3539	1583	1681	1745	1583	1770	1863	1583
Flt Permitted	0.184			0.098			0.950	0.986		0.950		
Satd. Flow (perm)	343	3539	1583	183	3539	1583	1681	1745	1583	1770	1863	1583
Right Turn on Red			Yes			Yes			Yes			Yes
Satd. Flow (RTOR)			159			117			341			164
Link Speed (mph)		30			30			30			30	
Link Distance (ft)		427			552			422			289	
Travel Time (s)		9.7			12.5			9.6			6.6	

Intersection Summary

Area Type: Other

Timings  
1: Dransfeldt Rd & Lincoln Ave

Lane Group	EBL	EBT	EBR	WBL	WBT	WBR	NBL	NBT	NBR	SBL	SBT	SBR
Lane Configurations												
Traffic Volume (vph)	83	1074	155	191	805	19	230	131	314	15	65	83
Future Volume (vph)	83	1074	155	191	805	19	230	131	314	15	65	83
Turn Type	pm+pt	NA	Perm	pm+pt	NA	Perm	Split	NA	Perm	Split	NA	Perm
Protected Phases	7	4		3	8		2	2		6	6	
Permitted Phases	4		4	8		8			2			6
Detector Phase	7	4	4	3	8	8	2	2	2	6	6	6
Switch Phase												
Minimum Initial (s)	3.0	10.0	10.0	4.0	10.0	10.0	5.0	5.0	5.0	5.0	5.0	5.0
Minimum Split (s)	10.0	40.0	40.0	9.5	35.0	35.0	35.0	35.0	35.0	35.0	35.0	35.0
Total Split (s)	10.0	40.0	40.0	20.0	50.0	50.0	35.0	35.0	35.0	35.0	35.0	35.0
Total Split (%)	7.7%	30.8%	30.8%	15.4%	38.5%	38.5%	26.9%	26.9%	26.9%	26.9%	26.9%	26.9%
Yellow Time (s)	4.0	4.0	4.0	3.0	3.0	3.0	3.5	3.5	3.5	3.5	3.5	3.5
All-Red Time (s)	2.0	2.0	2.0	2.0	2.0	2.0	2.0	2.0	2.0	2.0	2.0	2.0
Lost Time Adjust (s)	0.0	0.0	0.0	0.0	0.0	0.0	0.0	0.0	0.0	0.0	0.0	0.0
Total Lost Time (s)	6.0	6.0	6.0	5.0	5.0	5.0	5.5	5.5	5.5	5.5	5.5	5.5
Lead/Lag	Lead	Lag	Lag	Lead	Lag	Lag						
Lead-Lag Optimize?	Yes	Yes	Yes	Yes	Yes	Yes						
Recall Mode	None	None	None	None	None	None	C-Max	C-Max	C-Max	Max	Max	Max
Act Effct Green (s)	38.9	34.9	34.9	55.0	45.0	45.0	29.5	29.5	29.5	29.5	29.5	29.5
Actuated g/C Ratio	0.30	0.27	0.27	0.42	0.35	0.35	0.23	0.23	0.23	0.23	0.23	0.23
v/c Ratio	0.62	1.23	0.31	0.84	0.71	0.03	0.50	0.51	0.55	0.04	0.17	0.19
Control Delay	47.7	152.9	8.2	78.7	38.0	0.5	49.2	49.1	7.8	39.7	41.7	0.8
Queue Delay	0.0	0.0	0.0	0.0	0.0	0.0	0.0	0.0	0.0	0.0	0.0	0.0
Total Delay	47.7	152.9	8.2	78.7	38.0	0.5	49.2	49.1	7.8	39.7	41.7	0.8
LOS	D	F	A	E	D	A	D	D	A	D	D	A
Approach Delay		129.2			45.0			29.9			20.8	
Approach LOS		F			D			C			C	

Intersection Summary

Cycle Length: 130  
 Actuated Cycle Length: 130  
 Offset: 0 (0%), Referenced to phase 2:NBTL, Start of Green  
 Natural Cycle: 130  
 Control Type: Actuated-Coordinated  
 Maximum v/c Ratio: 1.23  
 Intersection Signal Delay: 75.4  
 Intersection LOS: E  
 Intersection Capacity Utilization 70.5%  
 ICU Level of Service C  
 Analysis Period (min) 15

Splits and Phases: 1: Dransfeldt Rd & Lincoln Ave

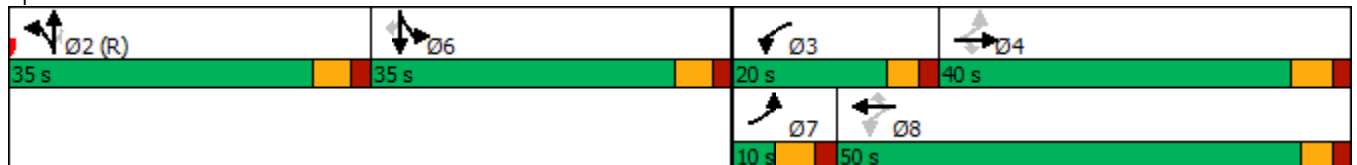

Queues

1: Dransfeldt Rd & Lincoln Ave

09/27/2020



Lane Group	EBL	EBT	EBR	WBL	WBT	WBR	NBL	NBT	NBR	SBL	SBT	SBR
Lane Group Flow (vph)	90	1167	168	208	875	21	192	200	341	16	71	90
v/c Ratio	0.62	1.23	0.31	0.84	0.71	0.03	0.50	0.51	0.55	0.04	0.17	0.19
Control Delay	47.7	152.9	8.2	78.7	38.0	0.5	49.2	49.1	7.8	39.7	41.7	0.8
Queue Delay	0.0	0.0	0.0	0.0	0.0	0.0	0.0	0.0	0.0	0.0	0.0	0.0
Total Delay	47.7	152.9	8.2	78.7	38.0	0.5	49.2	49.1	7.8	39.7	41.7	0.8
Queue Length 50th (ft)	46	-648	6	138	229	0	149	155	0	11	48	0
Queue Length 95th (ft)	#93	#787	62	m#247	429	m1	232	240	81	31	92	0
Internal Link Dist (ft)		347			472			342			209	
Turn Bay Length (ft)	200			330			300			100		
Base Capacity (vph)	146	950	541	260	1225	624	381	395	622	401	422	486
Starvation Cap Reductn	0	0	0	0	0	0	0	0	0	0	0	0
Spillback Cap Reductn	0	0	0	0	0	0	0	0	0	0	0	0
Storage Cap Reductn	0	0	0	0	0	0	0	0	0	0	0	0
Reduced v/c Ratio	0.62	1.23	0.31	0.80	0.71	0.03	0.50	0.51	0.55	0.04	0.17	0.19

Intersection Summary

- ~ Volume exceeds capacity, queue is theoretically infinite.  
Queue shown is maximum after two cycles.
- # 95th percentile volume exceeds capacity, queue may be longer.  
Queue shown is maximum after two cycles.
- m Volume for 95th percentile queue is metered by upstream signal.

HCM 6th Signalized Intersection Summary  
1: Dransfeldt Rd & Lincoln Ave

Lincoln & Dransfeldt  
09/27/2020

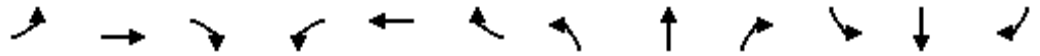

Movement	EBL	EBT	EBR	WBL	WBT	WBR	NBL	NBT	NBR	SBL	SBT	SBR
Lane Configurations												
Traffic Volume (veh/h)	83	1074	155	191	805	19	230	131	314	15	65	83
Future Volume (veh/h)	83	1074	155	191	805	19	230	131	314	15	65	83
Initial Q (Qb), veh	0	0	0	0	0	0	0	0	0	0	0	0
Ped-Bike Adj(A_pbT)	1.00		1.00	1.00		1.00	1.00		1.00	1.00		1.00
Parking Bus, Adj	1.00	1.00	1.00	1.00	1.00	1.00	1.00	1.00	1.00	1.00	1.00	1.00
Work Zone On Approach		No			No			No			No	
Adj Sat Flow, veh/h/ln	1870	1870	1870	1870	1870	1870	1870	1870	1870	1870	1870	1870
Adj Flow Rate, veh/h	90	1167	168	208	875	21	196	218	341	16	71	90
Peak Hour Factor	0.92	0.92	0.92	0.92	0.92	0.92	0.92	0.92	0.92	0.92	0.92	0.92
Percent Heavy Veh, %	2	2	2	2	2	2	2	2	2	2	2	2
Cap, veh/h	174	929	415	234	1148	512	432	453	384	404	424	360
Arrive On Green	0.03	0.26	0.26	0.10	0.32	0.32	0.24	0.24	0.24	0.23	0.23	0.23
Sat Flow, veh/h	1781	3554	1585	1781	3554	1585	1781	1870	1585	1781	1870	1585
Grp Volume(v), veh/h	90	1167	168	208	875	21	196	218	341	16	71	90
Grp Sat Flow(s),veh/h/ln	1781	1777	1585	1781	1777	1585	1781	1870	1585	1781	1870	1585
Q Serve(g_s), s	4.0	34.0	11.4	10.9	28.7	1.2	12.2	13.0	27.0	0.9	4.0	6.0
Cycle Q Clear(g_c), s	4.0	34.0	11.4	10.9	28.7	1.2	12.2	13.0	27.0	0.9	4.0	6.0
Prop In Lane	1.00		1.00	1.00		1.00	1.00		1.00	1.00		1.00
Lane Grp Cap(c), veh/h	174	929	415	234	1148	512	432	453	384	404	424	360
V/C Ratio(X)	0.52	1.26	0.41	0.89	0.76	0.04	0.45	0.48	0.89	0.04	0.17	0.25
Avail Cap(c_a), veh/h	174	929	415	261	1230	549	432	453	384	404	424	360
HCM Platoon Ratio	1.00	1.00	1.00	1.00	1.00	1.00	1.00	1.00	1.00	1.00	1.00	1.00
Upstream Filter(I)	1.00	1.00	1.00	1.00	1.00	1.00	1.00	1.00	1.00	1.00	1.00	1.00
Uniform Delay (d), s/veh	39.5	48.0	39.6	34.5	39.5	30.2	41.9	42.2	47.5	39.2	40.4	41.2
Incr Delay (d2), s/veh	2.7	123.9	0.6	27.4	2.7	0.0	3.4	3.6	24.9	0.2	0.9	1.7
Initial Q Delay(d3),s/veh	0.0	0.0	0.0	0.0	0.0	0.0	0.0	0.0	0.0	0.0	0.0	0.0
%ile BackOfQ(95%),veh/ln	1.7	45.5	8.0	10.7	18.8	0.8	9.8	10.7	19.3	0.8	3.5	4.6
Unsig. Movement Delay, s/veh												
LnGrp Delay(d),s/veh	42.2	171.9	40.3	62.0	42.2	30.2	45.4	45.9	72.4	39.4	41.2	42.8
LnGrp LOS	D	F	D	E	D	C	D	D	E	D	D	D
Approach Vol, veh/h		1425			1104			755			177	
Approach Delay, s/veh		148.2			45.7			57.7			41.9	
Approach LOS		F			D			E			D	
Timer - Assigned Phs		2	3	4		6	7	8				
Phs Duration (G+Y+Rc), s		37.0	18.0	40.0		35.0	10.0	48.0				
Change Period (Y+Rc), s		5.5	5.0	6.0		5.5	6.0	* 6				
Max Green Setting (Gmax), s		29.5	15.0	34.0		29.5	4.0	* 45				
Max Q Clear Time (g_c+I1), s		29.0	12.9	36.0		8.0	6.0	30.7				
Green Ext Time (p_c), s		0.2	0.1	0.0		0.6	0.0	5.4				

Intersection Summary

HCM 6th Ctrl Delay	90.3
HCM 6th LOS	F

Notes

- User approved pedestrian interval to be less than phase max green.
- User approved volume balancing among the lanes for turning movement.
- \* HCM 6th computational engine requires equal clearance times for the phases crossing the barrier.

Lanes and Geometrics  
2: Walgreens Access & Lincoln Ave

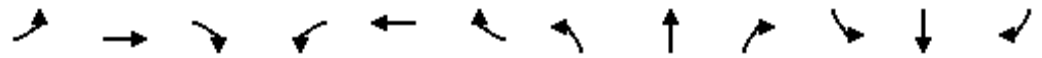

Lane Group	EBL	EBT	EBR	WBL	WBT	WBR	NBL	NBT	NBR	SBL	SBT	SBR
Lane Configurations		↑↑↑			↑↑↑				↑			↑
Ideal Flow (vphpl)	1900	1900	1900	1900	1900	1900	1900	1900	1900	1900	1900	1900
Lane Width (ft)	12	12	12	12	12	12	12	12	12	12	12	12
Grade (%)		0%			0%			0%			0%	
Storage Length (ft)	0		0	0		0	0		0	0		0
Storage Lanes	0		0	0		0	0		1	0		1
Taper Length (ft)	25			25			25			25		
Lane Util. Factor	1.00	0.91	0.91	1.00	0.91	0.91	1.00	1.00	1.00	1.00	1.00	1.00
Ped Bike Factor		0.994			0.988				0.865			0.865
Flt Protected												
Satd. Flow (prot)	0	5055	0	0	5024	0	0	0	1611	0	0	1611
Flt Permitted												
Satd. Flow (perm)	0	5055	0	0	5024	0	0	0	1611	0	0	1611
Link Speed (mph)		30			30			30				30
Link Distance (ft)		552			564			131				173
Travel Time (s)		12.5			12.8			3.0				3.9

Intersection Summary

Area Type: Other

Intersection												
Int Delay, s/veh	1.1											
Movement	EBL	EBT	EBR	WBL	WBT	WBR	NBL	NBT	NBR	SBL	SBT	SBR
Lane Configurations	↑↑↑			↑↑↑					↑			↑
Traffic Vol, veh/h	0	1350	53	0	909	77	0	0	46	0	0	106
Future Vol, veh/h	0	1350	53	0	909	77	0	0	46	0	0	106
Conflicting Peds, #/hr	0	0	0	0	0	0	0	0	0	0	0	0
Sign Control	Free	Free	Free	Free	Free	Free	Stop	Stop	Stop	Stop	Stop	Stop
RT Channelized	-	-	None	-	-	None	-	-	None	-	-	None
Storage Length	-	-	-	-	-	-	-	-	0	-	-	0
Veh in Median Storage, #	-	0	-	-	0	-	-	0	-	-	0	-
Grade, %	-	0	-	-	0	-	-	0	-	-	0	-
Peak Hour Factor	92	92	92	92	92	92	92	92	92	92	92	92
Heavy Vehicles, %	2	2	2	2	2	2	2	2	2	2	2	2
Mvmt Flow	0	1467	58	0	988	84	0	0	50	0	0	115

Major/Minor	Major1		Major2		Minor1		Minor2					
Conflicting Flow All	-	0	0	-	-	0	-	-	763	-	-	536
Stage 1	-	-	-	-	-	-	-	-	-	-	-	-
Stage 2	-	-	-	-	-	-	-	-	-	-	-	-
Critical Hdwy	-	-	-	-	-	-	-	-	7.14	-	-	7.14
Critical Hdwy Stg 1	-	-	-	-	-	-	-	-	-	-	-	-
Critical Hdwy Stg 2	-	-	-	-	-	-	-	-	-	-	-	-
Follow-up Hdwy	-	-	-	-	-	-	-	-	3.92	-	-	3.92
Pot Cap-1 Maneuver	0	-	-	0	-	-	0	0	298	0	0	419
Stage 1	0	-	-	0	-	-	0	0	-	0	0	-
Stage 2	0	-	-	0	-	-	0	0	-	0	0	-
Platoon blocked, %	-	-	-	-	-	-	-	-	-	-	-	-
Mov Cap-1 Maneuver	-	-	-	-	-	-	-	-	298	-	-	419
Mov Cap-2 Maneuver	-	-	-	-	-	-	-	-	-	-	-	-
Stage 1	-	-	-	-	-	-	-	-	-	-	-	-
Stage 2	-	-	-	-	-	-	-	-	-	-	-	-

Approach	EB	WB	NB	SB
HCM Control Delay, s	0	0	19.5	16.8
HCM LOS			C	C

Minor Lane/Major Mvmt	NBLn1	EBT	EBR	WBT	WBR	SBLn1
Capacity (veh/h)	298	-	-	-	-	419
HCM Lane V/C Ratio	0.168	-	-	-	-	0.275
HCM Control Delay (s)	19.5	-	-	-	-	16.8
HCM Lane LOS	C	-	-	-	-	C
HCM 95th %tile Q(veh)	0.6	-	-	-	-	1.1

Lanes and Geometrics  
3: Parker Rd & Lincoln Ave

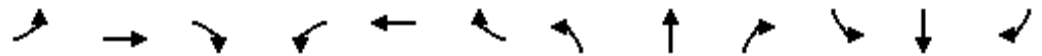

Lane Group	EBL	EBT	EBR	WBL	WBT	WBR	NBL	NBT	NBR	SBL	SBT	SBR
Lane Configurations												
Ideal Flow (vphpl)	1900	1900	1900	1900	1900	1900	1900	1900	1900	1900	1900	1900
Lane Width (ft)	12	12	12	12	12	12	12	12	12	12	12	12
Grade (%)		0%			0%			0%			0%	
Storage Length (ft)	275		0	200		0	500		0	400		0
Storage Lanes	2		1	2		1	2		1	2		1
Taper Length (ft)	25			25			25			25		
Lane Util. Factor	0.97	0.95	1.00	0.97	0.95	1.00	0.97	0.91	1.00	0.97	0.91	1.00
Ped Bike Factor												
Frt			0.850			0.850			0.850			0.850
Flt Protected	0.950			0.950			0.950			0.950		
Satd. Flow (prot)	3433	3539	1583	3433	3539	1583	3433	5085	1583	3433	5085	1583
Flt Permitted	0.950			0.950			0.950			0.950		
Satd. Flow (perm)	3433	3539	1583	3433	3539	1583	3433	5085	1583	3433	5085	1583
Right Turn on Red			Yes			Yes			Yes			Yes
Satd. Flow (RTOR)			259			265			151			206
Link Speed (mph)		30			30			30			30	
Link Distance (ft)		564			615			787			768	
Travel Time (s)		12.8			14.0			17.9			17.5	

Intersection Summary

Area Type: Other

Timings  
3: Parker Rd & Lincoln Ave

Lane Group	EBL	EBT	EBR	WBL	WBT	WBR	NBL	NBT	NBR	SBL	SBT	SBR
Lane Configurations												
Traffic Volume (vph)	512	581	301	149	352	244	359	1858	125	406	2248	276
Future Volume (vph)	512	581	301	149	352	244	359	1858	125	406	2248	276
Turn Type	Prot	NA	Perm	Prot	NA	Free	Prot	NA	Perm	Prot	NA	Free
Protected Phases	7	4		3	8		5	2		1	6	
Permitted Phases			4			Free			2			Free
Detector Phase	7	4	4	3	8		5	2	2	1	6	
Switch Phase												
Minimum Initial (s)	5.0	5.0	5.0	5.0	5.0		5.0	5.0	5.0	5.0	5.0	
Minimum Split (s)	10.0	35.0	35.0	10.0	35.0		15.0	30.5	30.5	10.0	30.5	
Total Split (s)	18.0	49.0	49.0	11.0	42.0		20.0	49.0	49.0	21.0	50.0	
Total Split (%)	13.8%	37.7%	37.7%	8.5%	32.3%		15.4%	37.7%	37.7%	16.2%	38.5%	
Yellow Time (s)	3.0	4.0	4.0	3.0	4.0		3.0	4.5	4.5	3.0	4.5	
All-Red Time (s)	2.0	2.0	2.0	2.0	2.0		2.0	2.0	2.0	2.0	2.0	
Lost Time Adjust (s)	0.0	0.0	0.0	0.0	0.0		0.0	0.0	0.0	0.0	0.0	
Total Lost Time (s)	5.0	6.0	6.0	5.0	6.0		5.0	6.5	6.5	5.0	6.5	
Lead/Lag	Lead	Lag	Lag	Lead	Lag		Lead	Lag	Lag	Lead	Lag	
Lead-Lag Optimize?	Yes	Yes	Yes	Yes	Yes		Yes	Yes	Yes	Yes	Yes	
Recall Mode	None	None	None	None	None		None	C-Max	C-Max	None	C-Max	
Act Effct Green (s)	13.0	32.1	32.1	6.0	25.1	130.0	20.5	46.2	46.2	23.2	48.9	130.0
Actuated g/C Ratio	0.10	0.25	0.25	0.05	0.19	1.00	0.16	0.36	0.36	0.18	0.38	1.00
v/c Ratio	1.62	0.72	0.56	1.03	0.56	0.17	0.72	1.12	0.21	0.72	1.28	0.19
Control Delay	316.8	63.7	35.3	138.3	49.9	0.2	60.4	100.6	4.4	58.1	163.9	0.3
Queue Delay	0.0	0.0	0.0	0.0	0.0	0.0	0.0	0.0	0.0	0.0	0.0	0.0
Total Delay	316.8	63.7	35.3	138.3	49.9	0.2	60.4	100.6	4.4	58.1	163.9	0.3
LOS	F	E	D	F	D	A	E	F	A	E	F	A
Approach Delay		150.6			51.3			89.3			133.8	
Approach LOS		F			D			F			F	

Intersection Summary

Cycle Length: 130  
 Actuated Cycle Length: 130  
 Offset: 0 (0%), Referenced to phase 2:NBT and 6:SBT, Start of Green  
 Natural Cycle: 145  
 Control Type: Actuated-Coordinated  
 Maximum v/c Ratio: 1.62  
 Intersection Signal Delay: 114.6  
 Intersection LOS: F  
 Intersection Capacity Utilization 96.8%  
 ICU Level of Service F  
 Analysis Period (min) 15

Splits and Phases: 3: Parker Rd & Lincoln Ave

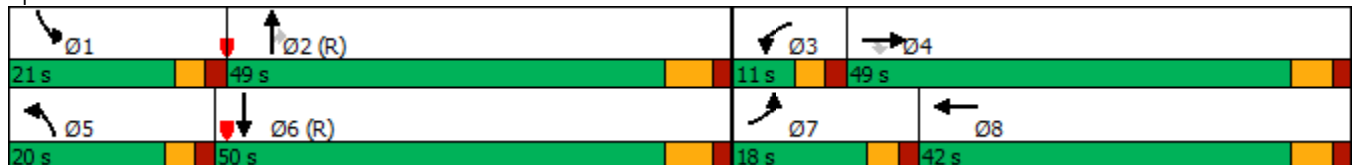

Queues  
3: Parker Rd & Lincoln Ave



Lane Group	EBL	EBT	EBR	WBL	WBT	WBR	NBL	NBT	NBR	SBL	SBT	SBR
Lane Group Flow (vph)	557	632	327	162	383	265	390	2020	136	441	2443	300
v/c Ratio	1.62	0.72	0.56	1.03	0.56	0.17	0.72	1.12	0.21	0.72	1.28	0.19
Control Delay	316.8	63.7	35.3	138.3	49.9	0.2	60.4	100.6	4.4	58.1	163.9	0.3
Queue Delay	0.0	0.0	0.0	0.0	0.0	0.0	0.0	0.0	0.0	0.0	0.0	0.0
Total Delay	316.8	63.7	35.3	138.3	49.9	0.2	60.4	100.6	4.4	58.1	163.9	0.3
Queue Length 50th (ft)	~354	291	183	~74	155	0	160	~732	0	179	~971	0
Queue Length 95th (ft)	m#315	m264	m168	#149	191	0	#248	#857	37	#287	#1111	0
Internal Link Dist (ft)		484			535			707			688	
Turn Bay Length (ft)	275			200			500			400		
Base Capacity (vph)	343	1170	696	158	980	1583	540	1806	659	612	1912	1583
Starvation Cap Reductn	0	0	0	0	0	0	0	0	0	0	0	0
Spillback Cap Reductn	0	0	0	0	0	0	0	0	0	0	0	0
Storage Cap Reductn	0	0	0	0	0	0	0	0	0	0	0	0
Reduced v/c Ratio	1.62	0.54	0.47	1.03	0.39	0.17	0.72	1.12	0.21	0.72	1.28	0.19

Intersection Summary

- ~ Volume exceeds capacity, queue is theoretically infinite.  
Queue shown is maximum after two cycles.
- # 95th percentile volume exceeds capacity, queue may be longer.  
Queue shown is maximum after two cycles.
- m Volume for 95th percentile queue is metered by upstream signal.

HCM 6th Signalized Intersection Summary  
3: Parker Rd & Lincoln Ave

Lincoln & Dransfeldt  
09/27/2020

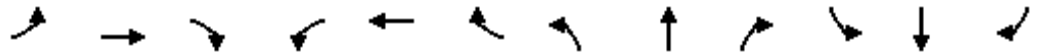

Movement	EBL	EBT	EBR	WBL	WBT	WBR	NBL	NBT	NBR	SBL	SBT	SBR
Lane Configurations	↔↔	↑↑	↗	↔↔	↑↑	↗	↔↔	↑↑↑	↗	↔↔	↑↑↑	↗
Traffic Volume (veh/h)	512	581	301	149	352	244	359	1858	125	406	2248	276
Future Volume (veh/h)	512	581	301	149	352	244	359	1858	125	406	2248	276
Initial Q (Qb), veh	0	0	0	0	0	0	0	0	0	0	0	0
Ped-Bike Adj(A_pbT)	1.00		1.00	1.00		1.00	1.00		1.00	1.00		1.00
Parking Bus, Adj	1.00	1.00	1.00	1.00	1.00	1.00	1.00	1.00	1.00	1.00	1.00	1.00
Work Zone On Approach		No			No			No			No	
Adj Sat Flow, veh/h/ln	1870	1870	1870	1870	1870	1870	1870	1870	1870	1870	1870	1870
Adj Flow Rate, veh/h	557	632	0	162	383	0	390	2020	0	441	2443	0
Peak Hour Factor	0.92	0.92	0.92	0.92	0.92	0.92	0.92	0.92	0.92	0.92	0.92	0.92
Percent Heavy Veh, %	2	2	2	2	2	2	2	2	2	2	2	2
Cap, veh/h	346	790		159	598		399	2223		425	2263	
Arrive On Green	0.03	0.07	0.00	0.05	0.17	0.00	0.12	0.44	0.00	0.12	0.44	0.00
Sat Flow, veh/h	3456	3554	1585	3456	3554	1585	3456	5106	1585	3456	5106	1585
Grp Volume(v), veh/h	557	632	0	162	383	0	390	2020	0	441	2443	0
Grp Sat Flow(s),veh/h/ln	1728	1777	1585	1728	1777	1585	1728	1702	1585	1728	1702	1585
Q Serve(g_s), s	13.0	22.8	0.0	6.0	13.1	0.0	14.6	48.0	0.0	16.0	57.6	0.0
Cycle Q Clear(g_c), s	13.0	22.8	0.0	6.0	13.1	0.0	14.6	48.0	0.0	16.0	57.6	0.0
Prop In Lane	1.00		1.00	1.00		1.00	1.00		1.00	1.00		1.00
Lane Grp Cap(c), veh/h	346	790		159	598		399	2223		425	2263	
V/C Ratio(X)	1.61	0.80		1.02	0.64		0.98	0.91		1.04	1.08	
Avail Cap(c_a), veh/h	346	1175		159	984		399	2223		425	2263	
HCM Platoon Ratio	0.33	0.33	0.33	1.00	1.00	1.00	1.00	1.00	1.00	1.00	1.00	1.00
Upstream Filter(I)	1.00	1.00	0.00	1.00	1.00	0.00	1.00	1.00	0.00	1.00	1.00	0.00
Uniform Delay (d), s/veh	62.9	57.4	0.0	62.0	50.4	0.0	57.3	34.3	0.0	57.0	36.2	0.0
Incr Delay (d2), s/veh	288.4	2.4	0.0	75.4	1.1	0.0	39.1	6.9	0.0	53.5	44.5	0.0
Initial Q Delay(d3),s/veh	0.0	0.0	0.0	0.0	0.0	0.0	0.0	0.0	0.0	0.0	0.0	0.0
%ile BackOfQ(95%),veh/ln	31.7	16.7	0.0	7.7	9.9	0.0	13.4	28.4	0.0	15.6	44.5	0.0
Unsig. Movement Delay, s/veh												
LnGrp Delay(d),s/veh	351.3	59.8	0.0	137.4	51.5	0.0	96.5	41.2	0.0	110.5	80.7	0.0
LnGrp LOS	F	E		F	D		F	D		F	F	
Approach Vol, veh/h		1189	A		545	A		2410	A		2884	A
Approach Delay, s/veh		196.4			77.1			50.1			85.3	
Approach LOS		F			E			D			F	
Timer - Assigned Phs	1	2	3	4	5	6	7	8				
Phs Duration (G+Y+Rc), s	21.0	63.1	11.0	34.9	20.0	64.1	18.0	27.9				
Change Period (Y+Rc), s	5.0	6.5	5.0	6.0	5.0	6.5	5.0	6.0				
Max Green Setting (Gmax), s	16.0	42.5	6.0	43.0	15.0	43.5	13.0	36.0				
Max Q Clear Time (g_c+I1), s	18.0	50.0	8.0	24.8	16.6	59.6	15.0	15.1				
Green Ext Time (p_c), s	0.0	0.0	0.0	4.1	0.0	0.0	0.0	2.4				

Intersection Summary

HCM 6th Ctrl Delay	91.4
HCM 6th LOS	F

Notes

Unsignalized Delay for [NBR, EBR, WBR, SBR] is excluded from calculations of the approach delay and intersection delay.

Lanes and Geometrics  
 4: Dransfeldt Rd & Lowe's Access



Lane Group	EBL	EBR	NBL	NBT	SBT	SBR
Lane Configurations						
Ideal Flow (vphp)	1900	1900	1900	1900	1900	1900
Lane Width (ft)	12	12	12	12	12	12
Grade (%)	0%			0%	0%	
Storage Length (ft)	0	0	125			0
Storage Lanes	1	0	1			0
Taper Length (ft)	25		25			
Lane Util. Factor	1.00	1.00	1.00	0.95	1.00	1.00
Ped Bike Factor						
Frt	0.940				0.980	
Flt Protected	0.973		0.950			
Satd. Flow (prot)	1704	0	1770	3539	1825	0
Flt Permitted	0.973		0.950			
Satd. Flow (perm)	1704	0	1770	3539	1825	0
Link Speed (mph)	30			30	30	
Link Distance (ft)	400			232	422	
Travel Time (s)	9.1			5.3	9.6	

Intersection Summary

Area Type: Other

Intersection						
Int Delay, s/veh	1.2					
Movement	EBL	EBR	NBL	NBT	SBT	SBR
Lane Configurations						
Traffic Vol, veh/h	44	35	16	631	350	60
Future Vol, veh/h	44	35	16	631	350	60
Conflicting Peds, #/hr	0	0	0	0	0	0
Sign Control	Stop	Stop	Free	Free	Free	Free
RT Channelized	-	None	-	None	-	None
Storage Length	0	-	125	-	-	-
Veh in Median Storage, #	0	-	-	0	0	-
Grade, %	0	-	-	0	0	-
Peak Hour Factor	92	92	92	92	92	92
Heavy Vehicles, %	2	2	2	2	2	2
Mvmt Flow	48	38	17	686	380	65



























Major/Minor	Minor2	Major1	Major2			
Conflicting Flow All	790	413	445	0	-	0
Stage 1	413	-	-	-	-	-
Stage 2	377	-	-	-	-	-
Critical Hdwy	6.63	6.23	4.13	-	-	-
Critical Hdwy Stg 1	5.43	-	-	-	-	-
Critical Hdwy Stg 2	5.83	-	-	-	-	-
Follow-up Hdwy	3.519	3.319	2.219	-	-	-
Pot Cap-1 Maneuver	343	638	1113	-	-	-
Stage 1	667	-	-	-	-	-
Stage 2	664	-	-	-	-	-
Platoon blocked, %				-	-	-
Mov Cap-1 Maneuver	338	638	1113	-	-	-
Mov Cap-2 Maneuver	338	-	-	-	-	-
Stage 1	657	-	-	-	-	-
Stage 2	664	-	-	-	-	-

Approach	EB	NB	SB
HCM Control Delay, s	15.5	0.2	0
HCM LOS	C		

Minor Lane/Major Mvmt	NBL	NBT	EBLn1	SBT	SBR
Capacity (veh/h)	1113	-	427	-	-
HCM Lane V/C Ratio	0.016	-	0.201	-	-
HCM Control Delay (s)	8.3	-	15.5	-	-
HCM Lane LOS	A	-	C	-	-
HCM 95th %tile Q(veh)	0	-	0.7	-	-

Lanes and Geometrics  
1: Dransfeldt Rd & Lincoln Ave

Lincoln & Dransfeldt  
09/27/2020

												
Lane Group	EBL	EBT	EBR	WBL	WBT	WBR	NBL	NBT	NBR	SBL	SBT	SBR
Lane Configurations		 			 		 					
Ideal Flow (vphpl)	1900	1900	1900	1900	1900	1900	1900	1900	1900	1900	1900	1900
Lane Width (ft)	12	12	12	12	12	12	12	12	12	12	12	12
Grade (%)		0%			0%			0%			0%	
Storage Length (ft)	200		0	330		0	125		0	100		0
Storage Lanes	1		1	1		1	1		1	1		1
Taper Length (ft)	25			25			25			25		
Lane Util. Factor	1.00	0.95	1.00	1.00	0.95	1.00	0.97	1.00	1.00	1.00	1.00	1.00
Ped Bike Factor			0.850			0.850			0.850			0.850
Flt Protected	0.950			0.950			0.950			0.950		
Satd. Flow (prot)	1770	3539	1583	1770	3539	1583	3433	1863	1583	1770	1863	1583
Flt Permitted	0.117			0.100			0.674			0.711		
Satd. Flow (perm)	218	3539	1583	186	3539	1583	2436	1863	1583	1324	1863	1583
Right Turn on Red			Yes			Yes			Yes			Yes
Satd. Flow (RTOR)			174			117			200			164
Link Speed (mph)		30			30			30			30	
Link Distance (ft)		427			552			346			289	
Travel Time (s)		9.7			12.5			7.9			6.6	

Intersection Summary

Area Type: Other

Timings  
1: Dransfeldt Rd & Lincoln Ave

Lane Group	EBL	EBT	EBR	WBL	WBT	WBR	NBL	NBT	NBR	SBL	SBT	SBR
Lane Configurations												
Traffic Volume (vph)	36	794	178	382	1142	4	188	64	184	3	87	46
Future Volume (vph)	36	794	178	382	1142	4	188	64	184	3	87	46
Turn Type	pm+pt	NA	Perm	pm+pt	NA	Perm	pm+pt	NA	pm+ov	pm+pt	NA	Perm
Protected Phases	7	4		3	8		5	2	3	1	6	
Permitted Phases	4		4	8		8	2		2	6		6
Detector Phase	7	4	4	3	8	8	5	2	3	1	6	6
Switch Phase												
Minimum Initial (s)	3.0	10.0	10.0	4.0	10.0	10.0	5.0	5.0	4.0	5.0	5.0	5.0
Minimum Split (s)	10.0	40.0	40.0	9.5	35.0	35.0	35.0	35.0	9.5	35.0	35.0	35.0
Total Split (s)	14.0	39.0	39.0	29.0	54.0	54.0	35.0	27.0	29.0	35.0	27.0	27.0
Total Split (%)	10.8%	30.0%	30.0%	22.3%	41.5%	41.5%	26.9%	20.8%	22.3%	26.9%	20.8%	20.8%
Yellow Time (s)	4.0	4.0	4.0	3.0	3.0	3.0	3.5	3.5	3.0	3.5	3.5	3.5
All-Red Time (s)	2.0	2.0	2.0	2.0	2.0	2.0	2.0	2.0	2.0	2.0	2.0	2.0
Lost Time Adjust (s)	0.0	0.0	0.0	0.0	0.0	0.0	0.0	0.0	0.0	0.0	0.0	0.0
Total Lost Time (s)	6.0	6.0	6.0	5.0	5.0	5.0	5.5	5.5	5.0	5.5	5.5	5.5
Lead/Lag	Lead	Lag	Lag	Lead	Lag	Lag	Lead	Lag	Lead	Lead	Lag	Lag
Lead-Lag Optimize?	Yes	Yes	Yes	Yes	Yes	Yes	Yes	Yes	Yes	Yes	Yes	Yes
Recall Mode	None	None	None	None	None	None	Max	C-Max	None	Max	Max	Max
Act Effect Green (s)	39.9	33.0	33.0	63.0	52.4	52.4	51.0	21.5	51.0	51.0	21.5	21.5
Actuated g/C Ratio	0.31	0.25	0.25	0.48	0.40	0.40	0.39	0.17	0.39	0.39	0.17	0.17
v/c Ratio	0.26	0.96	0.36	1.09	0.87	0.01	0.17	0.23	0.27	0.00	0.31	0.13
Control Delay	25.1	69.9	9.5	104.1	66.5	0.0	22.7	49.3	4.3	21.0	50.9	0.7
Queue Delay	0.0	0.0	0.0	0.0	0.0	0.0	0.0	0.0	0.0	0.0	0.0	0.0
Total Delay	25.1	69.9	9.5	104.1	66.5	0.0	22.7	49.3	4.3	21.0	50.9	0.7
LOS	C	E	A	F	E	A	C	D	A	C	D	A
Approach Delay		57.6			75.8			18.9			33.3	
Approach LOS		E			E			B			C	

Intersection Summary

Cycle Length: 130  
 Actuated Cycle Length: 130  
 Offset: 0 (0%), Referenced to phase 2:NBTL, Start of Green  
 Natural Cycle: 140  
 Control Type: Actuated-Coordinated  
 Maximum v/c Ratio: 1.09  
 Intersection Signal Delay: 60.0  
 Intersection LOS: E  
 Intersection Capacity Utilization 68.9%  
 ICU Level of Service C  
 Analysis Period (min) 15

Splits and Phases: 1: Dransfeldt Rd & Lincoln Ave

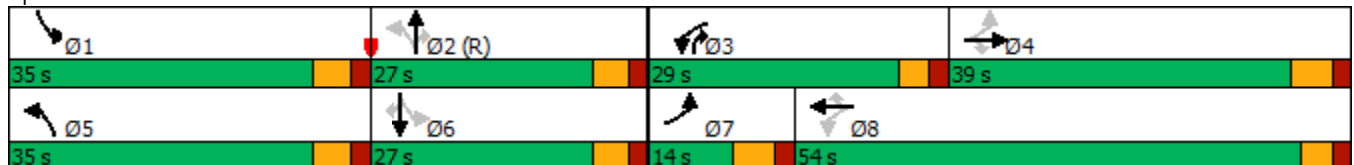

Queues

1: Dransfeldt Rd & Lincoln Ave

09/27/2020

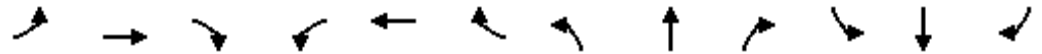

Lane Group	EBL	EBT	EBR	WBL	WBT	WBR	NBL	NBT	NBR	SBL	SBT	SBR
Lane Group Flow (vph)	39	863	193	415	1241	4	204	70	200	3	95	50
v/c Ratio	0.26	0.96	0.36	1.09	0.87	0.01	0.17	0.23	0.27	0.00	0.31	0.13
Control Delay	25.1	69.9	9.5	104.1	66.5	0.0	22.7	49.3	4.3	21.0	50.9	0.7
Queue Delay	0.0	0.0	0.0	0.0	0.0	0.0	0.0	0.0	0.0	0.0	0.0	0.0
Total Delay	25.1	69.9	9.5	104.1	66.5	0.0	22.7	49.3	4.3	21.0	50.9	0.7
Queue Length 50th (ft)	17	379	12	~352	576	0	52	52	0	1	71	0
Queue Length 95th (ft)	38	#512	74	m#434	m623	m0	77	98	48	8	125	0
Internal Link Dist (ft)		347			472			266			209	
Turn Bay Length (ft)	200			330			125			100		
Base Capacity (vph)	164	898	531	382	1426	707	1181	308	742	620	308	398
Starvation Cap Reductn	0	0	0	0	0	0	0	0	0	0	0	0
Spillback Cap Reductn	0	0	0	0	0	0	0	0	0	0	0	0
Storage Cap Reductn	0	0	0	0	0	0	0	0	0	0	0	0
Reduced v/c Ratio	0.24	0.96	0.36	1.09	0.87	0.01	0.17	0.23	0.27	0.00	0.31	0.13

Intersection Summary

- ~ Volume exceeds capacity, queue is theoretically infinite.  
Queue shown is maximum after two cycles.
- # 95th percentile volume exceeds capacity, queue may be longer.  
Queue shown is maximum after two cycles.
- m Volume for 95th percentile queue is metered by upstream signal.

HCM 6th Signalized Intersection Summary  
1: Dransfeldt Rd & Lincoln Ave

Lincoln & Dransfeldt  
09/27/2020

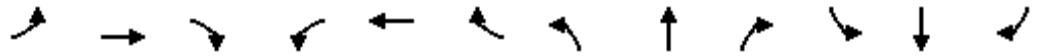

Movement	EBL	EBT	EBR	WBL	WBT	WBR	NBL	NBT	NBR	SBL	SBT	SBR
Lane Configurations	↘	↑↑	↗	↘	↑↑	↗	↘↗	↑	↗	↘	↑	↗
Traffic Volume (veh/h)	36	794	178	382	1142	4	188	64	184	3	87	46
Future Volume (veh/h)	36	794	178	382	1142	4	188	64	184	3	87	46
Initial Q (Qb), veh	0	0	0	0	0	0	0	0	0	0	0	0
Ped-Bike Adj(A_pbT)	1.00		1.00	1.00		1.00	1.00		1.00	1.00		1.00
Parking Bus, Adj	1.00	1.00	1.00	1.00	1.00	1.00	1.00	1.00	1.00	1.00	1.00	1.00
Work Zone On Approach		No			No			No			No	
Adj Sat Flow, veh/h/ln	1870	1870	1870	1870	1870	1870	1870	1870	1870	1870	1870	1870
Adj Flow Rate, veh/h	39	863	193	415	1241	4	204	70	200	3	95	50
Peak Hour Factor	0.92	0.92	0.92	0.92	0.92	0.92	0.92	0.92	0.92	0.92	0.92	0.92
Percent Heavy Veh, %	2	2	2	2	2	2	2	2	2	2	2	2
Cap, veh/h	138	902	402	392	1446	645	1186	309	555	607	309	262
Arrive On Green	0.02	0.25	0.25	0.18	0.41	0.41	0.23	0.17	0.17	0.23	0.17	0.17
Sat Flow, veh/h	1781	3554	1585	1781	3554	1585	3456	1870	1585	1781	1870	1585
Grp Volume(v), veh/h	39	863	193	415	1241	4	204	70	200	3	95	50
Grp Sat Flow(s),veh/h/ln	1781	1777	1585	1781	1777	1585	1728	1870	1585	1781	1870	1585
Q Serve(g_s), s	2.1	31.1	13.4	24.0	41.4	0.2	5.0	4.2	12.2	0.1	5.8	3.5
Cycle Q Clear(g_c), s	2.1	31.1	13.4	24.0	41.4	0.2	5.0	4.2	12.2	0.1	5.8	3.5
Prop In Lane	1.00		1.00	1.00		1.00	1.00		1.00	1.00		1.00
Lane Grp Cap(c), veh/h	138	902	402	392	1446	645	1186	309	555	607	309	262
V/C Ratio(X)	0.28	0.96	0.48	1.06	0.86	0.01	0.17	0.23	0.36	0.00	0.31	0.19
Avail Cap(c_a), veh/h	205	902	402	392	1446	645	1186	309	555	607	309	262
HCM Platoon Ratio	1.00	1.00	1.00	1.00	1.00	1.00	1.00	1.00	1.00	1.00	1.00	1.00
Upstream Filter(I)	1.00	1.00	1.00	1.00	1.00	1.00	1.00	1.00	1.00	1.00	1.00	1.00
Uniform Delay (d), s/veh	36.6	47.8	41.2	39.6	35.1	22.9	25.7	47.0	31.4	24.1	47.7	46.8
Incr Delay (d2), s/veh	1.1	20.2	0.9	61.8	5.4	0.0	0.3	1.7	1.8	0.0	2.6	1.6
Initial Q Delay(d3),s/veh	0.0	0.0	0.0	0.0	0.0	0.0	0.0	0.0	0.0	0.0	0.0	0.0
%ile BackOfQ(95%),veh/ln	1.7	22.8	9.2	22.2	25.9	0.1	3.8	3.8	8.7	0.1	5.3	2.7
Unsig. Movement Delay, s/veh												
LnGrp Delay(d),s/veh	37.7	68.0	42.1	101.4	40.5	22.9	26.0	48.7	33.2	24.1	50.3	48.4
LnGrp LOS	D	E	D	F	D	C	C	D	C	C	D	D
Approach Vol, veh/h		1095			1660			474			148	
Approach Delay, s/veh		62.3			55.7			32.4			49.1	
Approach LOS		E			E			C			D	
Timer - Assigned Phs	1	2	3	4	5	6	7	8				
Phs Duration (G+Y+Rc), s	35.0	27.0	29.0	39.0	35.0	27.0	9.1	58.9				
Change Period (Y+Rc), s	5.5	5.5	5.0	6.0	5.5	5.5	6.0	* 6				
Max Green Setting (Gmax), s	29.5	21.5	24.0	33.0	29.5	21.5	8.0	* 49				
Max Q Clear Time (g_c+I1), s	2.1	14.2	26.0	33.1	7.0	7.8	4.1	43.4				
Green Ext Time (p_c), s	0.0	0.6	0.0	0.0	0.7	0.5	0.0	3.8				

Intersection Summary

HCM 6th Ctrl Delay	54.3
HCM 6th LOS	D

Notes

User approved pedestrian interval to be less than phase max green.  
\* HCM 6th computational engine requires equal clearance times for the phases crossing the barrier.

Lanes and Geometrics  
2: Walgreens Access & Lincoln Ave

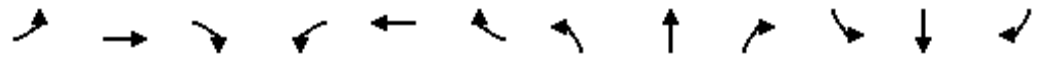

Lane Group	EBL	EBT	EBR	WBL	WBT	WBR	NBL	NBT	NBR	SBL	SBT	SBR
Lane Configurations		↑↑↑			↑↑↑				↑			↑
Ideal Flow (vphpl)	1900	1900	1900	1900	1900	1900	1900	1900	1900	1900	1900	1900
Lane Width (ft)	12	12	12	12	12	12	12	12	12	12	12	12
Grade (%)		0%			0%			0%			0%	
Storage Length (ft)	0		0	0		0	0		0	0		0
Storage Lanes	0		0	0		0	0		1	0		1
Taper Length (ft)	25			25			25			25		
Lane Util. Factor	1.00	0.91	0.91	1.00	0.91	0.91	1.00	1.00	1.00	1.00	1.00	1.00
Ped Bike Factor		0.990			0.997				0.865			0.865
Flt Protected												
Satd. Flow (prot)	0	5034	0	0	5070	0	0	0	1611	0	0	1611
Flt Permitted												
Satd. Flow (perm)	0	5034	0	0	5070	0	0	0	1611	0	0	1611
Link Speed (mph)		30			30			30			30	
Link Distance (ft)		552			564			131			173	
Travel Time (s)		12.5			12.8			3.0			3.9	

Intersection Summary

Area Type: Other

Intersection												
Int Delay, s/veh	2											
Movement	EBL	EBT	EBR	WBL	WBT	WBR	NBL	NBT	NBR	SBL	SBT	SBR
Lane Configurations	↑↑↑			↑↑↑					↑			↑
Traffic Vol, veh/h	0	917	63	0	1494	35	0	0	211	0	0	34
Future Vol, veh/h	0	917	63	0	1494	35	0	0	211	0	0	34
Conflicting Peds, #/hr	0	0	0	0	0	0	0	0	0	0	0	0
Sign Control	Free	Free	Free	Free	Free	Free	Stop	Stop	Stop	Stop	Stop	Stop
RT Channelized	-	-	None	-	-	None	-	-	None	-	-	None
Storage Length	-	-	-	-	-	-	-	-	0	-	-	0
Veh in Median Storage, #	-	0	-	-	0	-	-	0	-	-	0	-
Grade, %	-	0	-	-	0	-	-	0	-	-	0	-
Peak Hour Factor	92	92	92	92	92	92	92	92	92	92	92	92
Heavy Vehicles, %	2	2	2	2	2	2	2	2	2	2	2	2
Mvmt Flow	0	997	68	0	1624	38	0	0	229	0	0	37

Major/Minor	Major1		Major2		Minor1		Minor2					
Conflicting Flow All	-	0	0	-	-	0	-	-	533	-	-	831
Stage 1	-	-	-	-	-	-	-	-	-	-	-	-
Stage 2	-	-	-	-	-	-	-	-	-	-	-	-
Critical Hdwy	-	-	-	-	-	-	-	-	7.14	-	-	7.14
Critical Hdwy Stg 1	-	-	-	-	-	-	-	-	-	-	-	-
Critical Hdwy Stg 2	-	-	-	-	-	-	-	-	-	-	-	-
Follow-up Hdwy	-	-	-	-	-	-	-	-	3.92	-	-	3.92
Pot Cap-1 Maneuver	0	-	-	0	-	-	0	0	421	0	0	269
Stage 1	0	-	-	0	-	-	0	0	-	0	0	-
Stage 2	0	-	-	0	-	-	0	0	-	0	0	-
Platoon blocked, %	-	-	-	-	-	-	-	-	-	-	-	-
Mov Cap-1 Maneuver	-	-	-	-	-	-	-	-	421	-	-	269
Mov Cap-2 Maneuver	-	-	-	-	-	-	-	-	-	-	-	-
Stage 1	-	-	-	-	-	-	-	-	-	-	-	-
Stage 2	-	-	-	-	-	-	-	-	-	-	-	-

Approach	EB	WB	NB	SB
HCM Control Delay, s	0	0	23.3	20.5
HCM LOS			C	C

Minor Lane/Major Mvmt	NBLn1	EBT	EBR	WBT	WBR	SBLn1
Capacity (veh/h)	421	-	-	-	-	269
HCM Lane V/C Ratio	0.545	-	-	-	-	0.137
HCM Control Delay (s)	23.3	-	-	-	-	20.5
HCM Lane LOS	C	-	-	-	-	C
HCM 95th %tile Q(veh)	3.2	-	-	-	-	0.5

Lanes and Geometrics  
3: Parker Rd & Lincoln Ave

Lincoln & Dransfeldt

09/27/2020



Lane Group	EBL	EBT	EBR	WBL	WBT	WBR	NBL	NBT	NBR	SBL	SBT	SBR
Lane Configurations												
Ideal Flow (vphpl)	1900	1900	1900	1900	1900	1900	1900	1900	1900	1900	1900	1900
Lane Width (ft)	12	12	12	12	12	12	12	12	12	12	12	12
Grade (%)	0%		0%				0%			0%		
Storage Length (ft)	275		0	200		0	500		0	400		0
Storage Lanes	2		1	2		1	2		1	2		1
Taper Length (ft)	25			25			25			25		
Lane Util. Factor	0.97	0.95	1.00	0.97	0.95	1.00	0.97	0.91	1.00	0.97	0.91	1.00
Ped Bike Factor	0.850			0.850			0.850			0.850		
Flt Protected	0.950			0.950			0.950			0.950		
Satd. Flow (prot)	3433	3539	1583	3433	3539	1583	3433	5085	1583	3433	5085	1583
Flt Permitted	0.950			0.950			0.950			0.950		
Satd. Flow (perm)	3433	3539	1583	3433	3539	1583	3433	5085	1583	3433	5085	1583
Right Turn on Red			Yes			Yes			Yes			Yes
Satd. Flow (RTOR)			248			325			109			222
Link Speed (mph)		30			30			30				30
Link Distance (ft)		564			615			787				768
Travel Time (s)		12.8			14.0			17.9				17.5

Intersection Summary

Area Type: Other

Timings  
3: Parker Rd & Lincoln Ave

Lane Group	EBL	EBT	EBR	WBL	WBT	WBR	NBL	NBT	NBR	SBL	SBT	SBR
Lane Configurations												
Traffic Volume (vph)	329	469	305	160	713	400	461	1586	94	221	1329	354
Future Volume (vph)	329	469	305	160	713	400	461	1586	94	221	1329	354
Turn Type	Prot	NA	Perm	Prot	NA	Free	Prot	NA	Perm	Prot	NA	Free
Protected Phases	7	4		3	8		5	2		1	6	
Permitted Phases			4			Free			2			Free
Detector Phase	7	4	4	3	8		5	2	2	1	6	
Switch Phase												
Minimum Initial (s)	5.0	5.0	5.0	5.0	5.0		5.0	5.0	5.0	5.0	5.0	
Minimum Split (s)	10.0	35.0	35.0	10.0	35.0		15.0	30.5	30.5	10.0	30.5	
Total Split (s)	19.0	39.0	39.0	16.0	36.0		25.0	59.0	59.0	16.0	50.0	
Total Split (%)	14.6%	30.0%	30.0%	12.3%	27.7%		19.2%	45.4%	45.4%	12.3%	38.5%	
Yellow Time (s)	3.0	4.0	4.0	3.0	4.0		3.0	4.5	4.5	3.0	4.5	
All-Red Time (s)	2.0	2.0	2.0	2.0	2.0		2.0	2.0	2.0	2.0	2.0	
Lost Time Adjust (s)	0.0	0.0	0.0	0.0	0.0		0.0	0.0	0.0	0.0	0.0	
Total Lost Time (s)	5.0	6.0	6.0	5.0	6.0		5.0	6.5	6.5	5.0	6.5	
Lead/Lag	Lead	Lag	Lag	Lead	Lag		Lead	Lag	Lag	Lead	Lag	
Lead-Lag Optimize?	Yes	Yes	Yes	Yes	Yes		Yes	Yes	Yes	Yes	Yes	
Recall Mode	None	None	None	None	None		None	C-Max	C-Max	None	C-Max	
Act Effct Green (s)	14.0	33.6	33.6	10.4	30.0	130.0	20.0	52.5	52.5	11.0	43.5	130.0
Actuated g/C Ratio	0.11	0.26	0.26	0.08	0.23	1.00	0.15	0.40	0.40	0.08	0.33	1.00
v/c Ratio	0.97	0.56	0.56	0.63	0.95	0.27	0.95	0.84	0.14	0.83	0.85	0.24
Control Delay	110.0	41.7	15.6	68.6	70.7	0.4	82.8	39.6	4.3	81.7	46.0	0.4
Queue Delay	0.0	0.0	0.0	0.0	0.0	0.0	0.0	0.0	0.0	0.0	0.0	0.0
Total Delay	110.0	41.7	15.6	68.6	70.7	0.4	82.8	39.6	4.3	81.7	46.0	0.4
LOS	F	D	B	E	E	A	F	D	A	F	D	A
Approach Delay		54.9			48.4			47.4			41.7	
Approach LOS		D			D			D			D	

Intersection Summary

Cycle Length: 130  
 Actuated Cycle Length: 130  
 Offset: 0 (0%), Referenced to phase 2:NBT and 6:SBT, Start of Green  
 Natural Cycle: 105  
 Control Type: Actuated-Coordinated  
 Maximum v/c Ratio: 0.97  
 Intersection Signal Delay: 47.2  
 Intersection LOS: D  
 Intersection Capacity Utilization 86.7%  
 ICU Level of Service E  
 Analysis Period (min) 15

Splits and Phases: 3: Parker Rd & Lincoln Ave

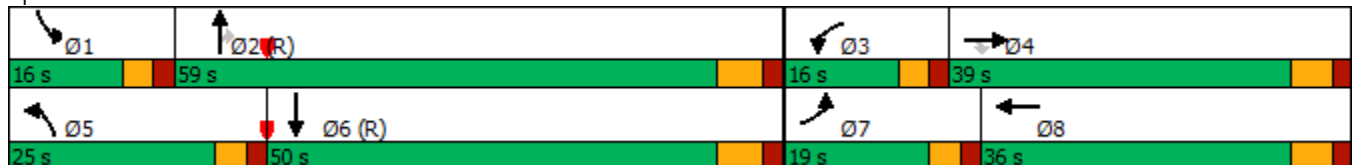

Queues  
3: Parker Rd & Lincoln Ave

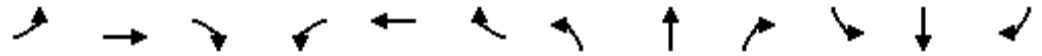

Lane Group	EBL	EBT	EBR	WBL	WBT	WBR	NBL	NBT	NBR	SBL	SBT	SBR
Lane Group Flow (vph)	358	510	332	174	775	435	501	1724	102	240	1445	385
v/c Ratio	0.97	0.56	0.56	0.63	0.95	0.27	0.95	0.84	0.14	0.83	0.85	0.24
Control Delay	110.0	41.7	15.6	68.6	70.7	0.4	82.8	39.6	4.3	81.7	46.0	0.4
Queue Delay	0.0	0.0	0.0	0.0	0.0	0.0	0.0	0.0	0.0	0.0	0.0	0.0
Total Delay	110.0	41.7	15.6	68.6	70.7	0.4	82.8	39.6	4.3	81.7	46.0	0.4
Queue Length 50th (ft)	163	134	73	74	341	0	218	474	0	104	413	0
Queue Length 95th (ft)	m#204	m157	m91	113	#465	0	#326	540	32	#173	477	0
Internal Link Dist (ft)		484			535			707			688	
Turn Bay Length (ft)	275			200			500			400		
Base Capacity (vph)	369	913	592	290	816	1583	528	2053	704	290	1701	1583
Starvation Cap Reductn	0	0	0	0	0	0	0	0	0	0	0	0
Spillback Cap Reductn	0	0	0	0	0	0	0	0	0	0	0	0
Storage Cap Reductn	0	0	0	0	0	0	0	0	0	0	0	0
Reduced v/c Ratio	0.97	0.56	0.56	0.60	0.95	0.27	0.95	0.84	0.14	0.83	0.85	0.24

Intersection Summary

- # 95th percentile volume exceeds capacity, queue may be longer.  
Queue shown is maximum after two cycles.
- m Volume for 95th percentile queue is metered by upstream signal.

HCM 6th Signalized Intersection Summary  
3: Parker Rd & Lincoln Ave

Lincoln & Dransfeldt

09/27/2020

Movement	EBL	EBT	EBR	WBL	WBT	WBR	NBL	NBT	NBR	SBL	SBT	SBR
Lane Configurations												
Traffic Volume (veh/h)	329	469	305	160	713	400	461	1586	94	221	1329	354
Future Volume (veh/h)	329	469	305	160	713	400	461	1586	94	221	1329	354
Initial Q (Qb), veh	0	0	0	0	0	0	0	0	0	0	0	0
Ped-Bike Adj(A_pbT)	1.00		1.00	1.00		1.00	1.00		1.00	1.00		1.00
Parking Bus, Adj	1.00	1.00	1.00	1.00	1.00	1.00	1.00	1.00	1.00	1.00	1.00	1.00
Work Zone On Approach		No			No			No			No	
Adj Sat Flow, veh/h/ln	1870	1870	1870	1870	1870	1870	1870	1870	1870	1870	1870	1870
Adj Flow Rate, veh/h	358	510	0	174	775	0	501	1724	0	240	1445	0
Peak Hour Factor	0.92	0.92	0.92	0.92	0.92	0.92	0.92	0.92	0.92	0.92	0.92	0.92
Percent Heavy Veh, %	2	2	2	2	2	2	2	2	2	2	2	2
Cap, veh/h	372	968		227	819		532	2068		290	1710	
Arrive On Green	0.18	0.45	0.00	0.07	0.23	0.00	0.15	0.40	0.00	0.08	0.33	0.00
Sat Flow, veh/h	3456	3554	1585	3456	3554	1585	3456	5106	1585	3456	5106	1585
Grp Volume(v), veh/h	358	510	0	174	775	0	501	1724	0	240	1445	0
Grp Sat Flow(s),veh/h/ln	1728	1777	1585	1728	1777	1585	1728	1702	1585	1728	1702	1585
Q Serve(g_s), s	13.4	13.4	0.0	6.4	27.9	0.0	18.7	39.4	0.0	8.9	34.1	0.0
Cycle Q Clear(g_c), s	13.4	13.4	0.0	6.4	27.9	0.0	18.7	39.4	0.0	8.9	34.1	0.0
Prop In Lane	1.00		1.00	1.00		1.00	1.00		1.00	1.00		1.00
Lane Grp Cap(c), veh/h	372	968		227	819		532	2068		290	1710	
V/C Ratio(X)	0.96	0.53		0.77	0.95		0.94	0.83		0.83	0.84	
Avail Cap(c_a), veh/h	372	968		292	820		532	2068		292	1710	
HCM Platoon Ratio	1.67	1.67	1.67	1.00	1.00	1.00	1.00	1.00	1.00	1.00	1.00	1.00
Upstream Filter(I)	1.00	1.00	0.00	1.00	1.00	0.00	1.00	1.00	0.00	1.00	1.00	0.00
Uniform Delay (d), s/veh	53.0	29.4	0.0	59.7	49.2	0.0	54.4	34.7	0.0	58.6	40.1	0.0
Incr Delay (d2), s/veh	36.6	0.5	0.0	8.7	19.6	0.0	25.4	4.1	0.0	17.6	5.3	0.0
Initial Q Delay(d3),s/veh	0.0	0.0	0.0	0.0	0.0	0.0	0.0	0.0	0.0	0.0	0.0	0.0
%ile BackOfQ(95%),veh/ln	11.7	8.8	0.0	5.6	20.8	0.0	15.2	23.7	0.0	8.1	21.4	0.0
Unsig. Movement Delay, s/veh												
LnGrp Delay(d),s/veh	89.7	30.0	0.0	68.5	68.8	0.0	79.9	38.9	0.0	76.2	45.4	0.0
LnGrp LOS	F	C		E	E		E	D		E	D	
Approach Vol, veh/h		868	A		949	A		2225	A		1685	A
Approach Delay, s/veh		54.6			68.7			48.1			49.8	
Approach LOS		D			E			D			D	
Timer - Assigned Phs	1	2	3	4	5	6	7	8				
Phs Duration (G+Y+Rc), s	15.9	59.1	13.6	41.4	25.0	50.0	19.0	36.0				
Change Period (Y+Rc), s	5.0	6.5	5.0	6.0	5.0	6.5	5.0	6.0				
Max Green Setting (Gmax), s	11.0	52.5	11.0	33.0	20.0	43.5	14.0	30.0				
Max Q Clear Time (g_c+I1), s	10.9	41.4	8.4	15.4	20.7	36.1	15.4	29.9				
Green Ext Time (p_c), s	0.0	8.2	0.1	3.2	0.0	5.2	0.0	0.1				

Intersection Summary

HCM 6th Ctrl Delay	53.0
HCM 6th LOS	D

Notes

Unsignalized Delay for [NBR, EBR, WBR, SBR] is excluded from calculations of the approach delay and intersection delay.

Lanes and Geometrics  
4: Dransfeldt Rd & Lowe's Access



Lane Group	EBL	EBT	EBR	WBL	WBT	WBR	NBL	NBT	NBR	SBL	SBT	SBR
Lane Configurations		↕			↕	↗	↖	↕		↖	↕	
Ideal Flow (vphpl)	1900	1900	1900	1900	1900	1900	1900	1900	1900	1900	1900	1900
Lane Width (ft)	12	12	12	12	12	12	12	12	12	12	12	12
Grade (%)		0%			0%			0%			0%	
Storage Length (ft)	100		0	100		0	125		0	100		0
Storage Lanes	0		0	0		1	1		0	1		0
Taper Length (ft)	25			25			25			25		
Lane Util. Factor	1.00	1.00	1.00	1.00	1.00	1.00	1.00	0.95	0.95	1.00	0.95	0.95
Ped Bike Factor		0.957				0.850		0.982			0.981	
Flt Protected		0.982			0.968		0.950		0.950			
Satd. Flow (prot)	0	1751	0	0	1803	1583	1770	3476	0	1770	3472	0
Flt Permitted		0.982			0.968		0.950		0.950			
Satd. Flow (perm)	0	1751	0	0	1803	1583	1770	3476	0	1770	3472	0
Link Speed (mph)		30			30			30			30	
Link Distance (ft)		400			302			232			346	
Travel Time (s)		9.1			6.9			5.3			7.9	

Intersection Summary

Area Type: Other

Intersection												
Int Delay, s/veh	12.2											
Movement	EBL	EBT	EBR	WBL	WBT	WBR	NBL	NBT	NBR	SBL	SBT	SBR
Lane Configurations		↕			↕	↕	↕	↕		↕	↕	
Traffic Vol, veh/h	25	20	21	39	20	137	17	288	40	300	303	45
Future Vol, veh/h	25	20	21	39	20	137	17	288	40	300	303	45
Conflicting Peds, #/hr	0	0	0	0	0	0	0	0	0	0	0	0
Sign Control	Stop	Stop	Stop	Stop	Stop	Stop	Free	Free	Free	Free	Free	Free
RT Channelized	-	-	None	-	-	None	-	-	None	-	-	None
Storage Length	-	-	-	-	-	0	125	-	-	100	-	-
Veh in Median Storage, #	-	0	-	-	0	-	-	0	-	-	0	-
Grade, %	-	0	-	-	0	-	-	0	-	-	0	-
Peak Hour Factor	92	92	92	92	92	92	92	92	92	92	92	92
Heavy Vehicles, %	2	2	2	2	2	2	2	2	2	2	2	2
Mvmt Flow	27	22	23	42	22	149	18	313	43	326	329	49



























Major/Minor	Minor2		Minor1		Major1		Major2					
Conflicting Flow All	1210	1398	189	1199	1401	178	378	0	0	356	0	0
Stage 1	1006	1006	-	371	371	-	-	-	-	-	-	-
Stage 2	204	392	-	828	1030	-	-	-	-	-	-	-
Critical Hdwy	7.54	6.54	6.94	7.54	6.54	6.94	4.14	-	-	4.14	-	-
Critical Hdwy Stg 1	6.54	5.54	-	6.54	5.54	-	-	-	-	-	-	-
Critical Hdwy Stg 2	6.54	5.54	-	6.54	5.54	-	-	-	-	-	-	-
Follow-up Hdwy	3.52	4.02	3.32	3.52	4.02	3.32	2.22	-	-	2.22	-	-
Pot Cap-1 Maneuver	138	140	821	141	139	834	1177	-	-	1199	-	-
Stage 1	258	317	-	622	618	-	-	-	-	-	-	-
Stage 2	779	605	-	332	309	-	-	-	-	-	-	-
Platoon blocked, %								-	-	-	-	-
Mov Cap-1 Maneuver	74	100	821	90	100	834	1177	-	-	1199	-	-
Mov Cap-2 Maneuver	74	100	-	90	100	-	-	-	-	-	-	-
Stage 1	254	231	-	613	609	-	-	-	-	-	-	-
Stage 2	608	596	-	213	225	-	-	-	-	-	-	-

Approach	EB		WB		NB		SB	
HCM Control Delay, s	75.5		38.4		0.4		4.2	
HCM LOS	F		E					

Minor Lane/Major Mvmt	NBL	NBT	NBR	EBLn1	WBLn1	WBLn2	SBL	SBT	SBR
Capacity (veh/h)	1177	-	-	117	93	834	1199	-	-
HCM Lane V/C Ratio	0.016	-	-	0.613	0.69	0.179	0.272	-	-
HCM Control Delay (s)	8.1	-	-	75.5	103.8	10.3	9.1	-	-
HCM Lane LOS	A	-	-	F	F	B	A	-	-
HCM 95th %tile Q(veh)	0	-	-	3.1	3.4	0.6	1.1	-	-

Lanes and Geometrics  
1: Dransfeldt Rd & Lincoln Ave

Lincoln & Dransfeldt  
09/27/2020

												
Lane Group	EBL	EBT	EBR	WBL	WBT	WBR	NBL	NBT	NBR	SBL	SBT	SBR
Lane Configurations		 			 		 					
Ideal Flow (vphpl)	1900	1900	1900	1900	1900	1900	1900	1900	1900	1900	1900	1900
Lane Width (ft)	12	12	12	12	12	12	12	12	12	12	12	12
Grade (%)		0%			0%			0%			0%	
Storage Length (ft)	200		0	330		0	125		225	100		0
Storage Lanes	1		1	1		1	1		1	1		1
Taper Length (ft)	25			25			25			25		
Lane Util. Factor	1.00	0.95	1.00	1.00	0.95	1.00	0.97	1.00	1.00	1.00	1.00	1.00
Ped Bike Factor			0.850			0.850			0.850			0.850
Flt Protected	0.950			0.950			0.950			0.950		
Satd. Flow (prot)	1770	3539	1583	1770	3539	1583	3433	1863	1583	1770	1863	1583
Flt Permitted	0.296			0.082			0.604			0.595		
Satd. Flow (perm)	551	3539	1583	153	3539	1583	2183	1863	1583	1108	1863	1583
Right Turn on Red			Yes			Yes			Yes			Yes
Satd. Flow (RTOR)			146			117			282			122
Link Speed (mph)		30			30			30			30	
Link Distance (ft)		427			552			351			289	
Travel Time (s)		9.7			12.5			8.0			6.6	

Intersection Summary

Area Type: Other

Timings  
1: Dransfeldt Rd & Lincoln Ave

Lane Group	EBL	EBT	EBR	WBL	WBT	WBR	NBL	NBT	NBR	SBL	SBT	SBR
Lane Configurations												
Traffic Volume (vph)	83	1106	187	384	805	19	294	147	346	15	82	83
Future Volume (vph)	83	1106	187	384	805	19	294	147	346	15	82	83
Turn Type	pm+pt	NA	Perm	pm+pt	NA	Perm	pm+pt	NA	pm+ov	pm+pt	NA	Perm
Protected Phases	7	4		3	8		5	2	3	1	6	
Permitted Phases	4		4	8		8	2		2	6		6
Detector Phase	7	4	4	3	8	8	5	2	3	1	6	6
Switch Phase												
Minimum Initial (s)	3.0	10.0	10.0	4.0	10.0	10.0	5.0	5.0	4.0	5.0	5.0	5.0
Minimum Split (s)	10.0	40.0	40.0	9.5	35.0	35.0	35.0	35.0	9.5	35.0	35.0	35.0
Total Split (s)	27.0	49.0	49.0	30.0	52.0	52.0	25.0	29.0	30.0	22.0	26.0	26.0
Total Split (%)	20.8%	37.7%	37.7%	23.1%	40.0%	40.0%	19.2%	22.3%	23.1%	16.9%	20.0%	20.0%
Yellow Time (s)	4.0	4.0	4.0	3.0	3.0	3.0	3.5	3.5	3.0	3.5	3.5	3.5
All-Red Time (s)	2.0	2.0	2.0	2.0	2.0	2.0	2.0	2.0	2.0	2.0	2.0	2.0
Lost Time Adjust (s)	0.0	0.0	0.0	0.0	0.0	0.0	0.0	0.0	0.0	0.0	0.0	0.0
Total Lost Time (s)	6.0	6.0	6.0	5.0	5.0	5.0	5.5	5.5	5.0	5.5	5.5	5.5
Lead/Lag	Lead	Lag	Lag	Lead	Lag	Lag	Lead	Lag	Lead	Lead	Lag	Lag
Lead-Lag Optimize?	Yes	Yes	Yes	Yes	Yes	Yes	Yes	Yes	Yes	Yes	Yes	Yes
Recall Mode	None	None	None	None	None	None	Max	C-Max	None	Max	Max	Max
Act Effct Green (s)	51.5	43.0	43.0	74.0	59.5	59.5	43.0	23.5	54.0	37.0	20.5	20.5
Actuated g/C Ratio	0.40	0.33	0.33	0.57	0.46	0.46	0.33	0.18	0.42	0.28	0.16	0.16
v/c Ratio	0.30	1.03	0.33	1.05	0.54	0.03	0.35	0.48	0.46	0.04	0.30	0.26
Control Delay	18.0	76.2	11.5	96.3	33.8	0.6	31.6	53.1	8.7	28.5	51.7	5.1
Queue Delay	0.0	0.0	0.0	0.0	0.0	0.0	0.0	0.0	0.0	0.0	0.0	0.0
Total Delay	18.0	76.2	11.5	96.3	33.8	0.6	31.6	53.1	8.7	28.5	51.7	5.1
LOS	B	E	B	F	C	A	C	D	A	C	D	A
Approach Delay		63.9			53.1			25.6			28.3	
Approach LOS		E			D			C			C	

Intersection Summary

Cycle Length: 130  
 Actuated Cycle Length: 130  
 Offset: 0 (0%), Referenced to phase 2:NBTL, Start of Green  
 Natural Cycle: 150  
 Control Type: Actuated-Coordinated  
 Maximum v/c Ratio: 1.05  
 Intersection Signal Delay: 49.9  
 Intersection LOS: D  
 Intersection Capacity Utilization 80.7%  
 ICU Level of Service D  
 Analysis Period (min) 15

Splits and Phases: 1: Dransfeldt Rd & Lincoln Ave

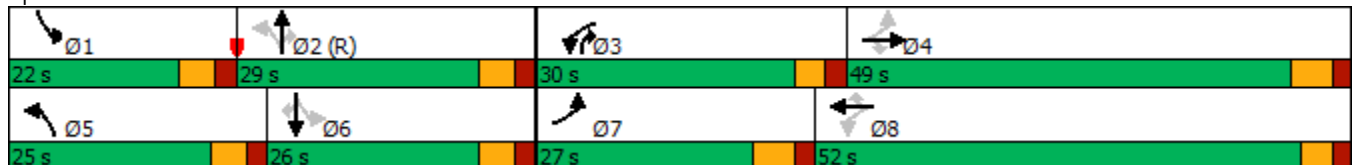

Queues  
1: Dransfeldt Rd & Lincoln Ave

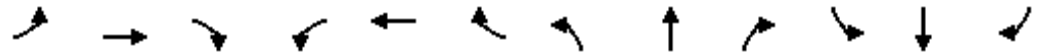

Lane Group	EBL	EBT	EBR	WBL	WBT	WBR	NBL	NBT	NBR	SBL	SBT	SBR
Lane Group Flow (vph)	90	1202	203	417	875	21	320	160	376	16	89	90
v/c Ratio	0.30	1.03	0.33	1.05	0.54	0.03	0.35	0.48	0.46	0.04	0.30	0.26
Control Delay	18.0	76.2	11.5	96.3	33.8	0.6	31.6	53.1	8.7	28.5	51.7	5.1
Queue Delay	0.0	0.0	0.0	0.0	0.0	0.0	0.0	0.0	0.0	0.0	0.0	0.0
Total Delay	18.0	76.2	11.5	96.3	33.8	0.6	31.6	53.1	8.7	28.5	51.7	5.1
Queue Length 50th (ft)	34	~568	33	~340	271	0	98	122	49	9	67	0
Queue Length 95th (ft)	60	#706	94	#551	353	m1	137	194	130	26	121	24
Internal Link Dist (ft)		347			472			271			209	
Turn Bay Length (ft)	200			330			125		225	100		
Base Capacity (vph)	468	1170	621	398	1618	787	909	336	822	399	293	352
Starvation Cap Reductn	0	0	0	0	0	0	0	0	0	0	0	0
Spillback Cap Reductn	0	0	0	0	0	0	0	0	0	0	0	0
Storage Cap Reductn	0	0	0	0	0	0	0	0	0	0	0	0
Reduced v/c Ratio	0.19	1.03	0.33	1.05	0.54	0.03	0.35	0.48	0.46	0.04	0.30	0.26

Intersection Summary

- ~ Volume exceeds capacity, queue is theoretically infinite.  
Queue shown is maximum after two cycles.
- # 95th percentile volume exceeds capacity, queue may be longer.  
Queue shown is maximum after two cycles.
- m Volume for 95th percentile queue is metered by upstream signal.

HCM 6th Signalized Intersection Summary  
1: Dransfeldt Rd & Lincoln Ave

Lincoln & Dransfeldt  
09/27/2020

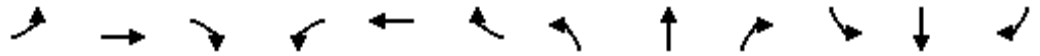

Movement	EBL	EBT	EBR	WBL	WBT	WBR	NBL	NBT	NBR	SBL	SBT	SBR
Lane Configurations												
Traffic Volume (veh/h)	83	1106	187	384	805	19	294	147	346	15	82	83
Future Volume (veh/h)	83	1106	187	384	805	19	294	147	346	15	82	83
Initial Q (Qb), veh	0	0	0	0	0	0	0	0	0	0	0	0
Ped-Bike Adj(A_pbT)	1.00		1.00	1.00		1.00	1.00		1.00	1.00		1.00
Parking Bus, Adj	1.00	1.00	1.00	1.00	1.00	1.00	1.00	1.00	1.00	1.00	1.00	1.00
Work Zone On Approach		No			No			No			No	
Adj Sat Flow, veh/h/ln	1870	1870	1870	1870	1870	1870	1870	1870	1870	1870	1870	1870
Adj Flow Rate, veh/h	90	1202	203	417	875	21	320	160	376	16	89	90
Peak Hour Factor	0.92	0.92	0.92	0.92	0.92	0.92	0.92	0.92	0.92	0.92	0.92	0.92
Percent Heavy Veh, %	2	2	2	2	2	2	2	2	2	2	2	2
Cap, veh/h	323	1175	524	398	1662	741	899	338	591	372	295	250
Arrive On Green	0.05	0.33	0.33	0.19	0.47	0.47	0.15	0.18	0.18	0.13	0.16	0.16
Sat Flow, veh/h	1781	3554	1585	1781	3554	1585	3456	1870	1585	1781	1870	1585
Grp Volume(v), veh/h	90	1202	203	417	875	21	320	160	376	16	89	90
Grp Sat Flow(s),veh/h/ln	1781	1777	1585	1781	1777	1585	1728	1870	1585	1781	1870	1585
Q Serve(g_s), s	4.3	43.0	12.8	25.0	22.6	0.9	9.2	10.0	23.5	0.8	5.5	6.6
Cycle Q Clear(g_c), s	4.3	43.0	12.8	25.0	22.6	0.9	9.2	10.0	23.5	0.8	5.5	6.6
Prop In Lane	1.00		1.00	1.00		1.00	1.00		1.00	1.00		1.00
Lane Grp Cap(c), veh/h	323	1175	524	398	1662	741	899	338	591	372	295	250
V/C Ratio(X)	0.28	1.02	0.39	1.05	0.53	0.03	0.36	0.47	0.64	0.04	0.30	0.36
Avail Cap(c_a), veh/h	526	1175	524	398	1662	741	899	338	591	372	295	250
HCM Platoon Ratio	1.00	1.00	1.00	1.00	1.00	1.00	1.00	1.00	1.00	1.00	1.00	1.00
Upstream Filter(I)	1.00	1.00	1.00	1.00	1.00	1.00	1.00	1.00	1.00	1.00	1.00	1.00
Uniform Delay (d), s/veh	26.5	43.5	33.4	42.4	24.4	18.7	34.5	47.7	33.5	33.8	48.4	48.9
Incr Delay (d2), s/veh	0.5	32.1	0.5	58.2	0.3	0.0	1.1	4.7	5.2	0.2	2.6	4.0
Initial Q Delay(d3),s/veh	0.0	0.0	0.0	0.0	0.0	0.0	0.0	0.0	0.0	0.0	0.0	0.0
%ile BackOfQ(95%),veh/ln	3.4	32.4	8.7	21.6	14.6	0.6	7.3	8.8	15.9	0.7	5.0	5.2
Unsig. Movement Delay, s/veh												
LnGrp Delay(d),s/veh	27.0	75.6	33.9	100.6	24.8	18.7	35.6	52.4	38.6	34.0	51.0	52.9
LnGrp LOS	C	F	C	F	C	B	D	D	D	C	D	D
Approach Vol, veh/h		1495			1313			856			195	
Approach Delay, s/veh		67.0			48.7			40.1			50.5	
Approach LOS		E			D			D			D	
Timer - Assigned Phs	1	2	3	4	5	6	7	8				
Phs Duration (G+Y+Rc), s	22.0	29.0	30.0	49.0	25.0	26.0	12.2	66.8				
Change Period (Y+Rc), s	5.5	5.5	5.0	6.0	5.5	5.5	6.0	* 6				
Max Green Setting (Gmax), s	16.5	23.5	25.0	43.0	19.5	20.5	21.0	* 47				
Max Q Clear Time (g_c+I1), s	2.8	25.5	27.0	45.0	11.2	8.6	6.3	24.6				
Green Ext Time (p_c), s	0.0	0.0	0.0	0.0	0.7	0.5	0.2	6.6				

Intersection Summary

HCM 6th Ctrl Delay	54.0
HCM 6th LOS	D

Notes

User approved pedestrian interval to be less than phase max green.  
\* HCM 6th computational engine requires equal clearance times for the phases crossing the barrier.

Lanes and Geometrics  
2: Walgreens Access & Lincoln Ave

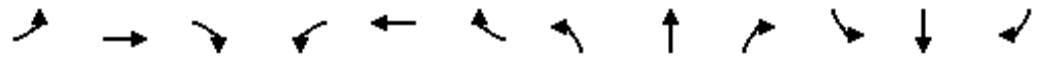

Lane Group	EBL	EBT	EBR	WBL	WBT	WBR	NBL	NBT	NBR	SBL	SBT	SBR
Lane Configurations		↑↑↑			↑↑↑				↑			↑
Ideal Flow (vphpl)	1900	1900	1900	1900	1900	1900	1900	1900	1900	1900	1900	1900
Lane Width (ft)	12	12	12	12	12	12	12	12	12	12	12	12
Grade (%)		0%			0%			0%			0%	
Storage Length (ft)	0		0	0		0	0		0	0		0
Storage Lanes	0		0	0		0	0		1	0		1
Taper Length (ft)	25			25			25			25		
Lane Util. Factor	1.00	0.91	0.91	1.00	0.91	0.91	1.00	1.00	1.00	1.00	1.00	1.00
Ped Bike Factor		0.991			0.990				0.865			0.865
Flt Protected												
Satd. Flow (prot)	0	5040	0	0	5034	0	0	0	1611	0	0	1611
Flt Permitted												
Satd. Flow (perm)	0	5040	0	0	5034	0	0	0	1611	0	0	1611
Link Speed (mph)		30			30			30				30
Link Distance (ft)		552			564			131				173
Travel Time (s)		12.5			12.8			3.0				3.9

Intersection Summary

Area Type: Other

Intersection												
Int Delay, s/veh	5.9											
Movement	EBL	EBT	EBR	WBL	WBT	WBR	NBL	NBT	NBR	SBL	SBT	SBR
Lane Configurations	↑↑↑			↑↑↑					↑			↑
Traffic Vol, veh/h	0	1377	90	0	1102	77	0	0	230	0	0	106
Future Vol, veh/h	0	1377	90	0	1102	77	0	0	230	0	0	106
Conflicting Peds, #/hr	0	0	0	0	0	0	0	0	0	0	0	0
Sign Control	Free	Free	Free	Free	Free	Free	Stop	Stop	Stop	Stop	Stop	Stop
RT Channelized	-	-	None	-	-	None	-	-	None	-	-	None
Storage Length	-	-	-	-	-	-	-	-	0	-	-	0
Veh in Median Storage, #	-	0	-	-	0	-	-	0	-	-	0	-
Grade, %	-	0	-	-	0	-	-	0	-	-	0	-
Peak Hour Factor	92	92	92	92	92	92	92	92	92	92	92	92
Heavy Vehicles, %	2	2	2	2	2	2	2	2	2	2	2	2
Mvmt Flow	0	1497	98	0	1198	84	0	0	250	0	0	115

Major/Minor	Major1		Major2		Minor1		Minor2					
Conflicting Flow All	-	0	0	-	-	0	-	-	798	-	-	641
Stage 1	-	-	-	-	-	-	-	-	-	-	-	-
Stage 2	-	-	-	-	-	-	-	-	-	-	-	-
Critical Hdwy	-	-	-	-	-	-	-	-	7.14	-	-	7.14
Critical Hdwy Stg 1	-	-	-	-	-	-	-	-	-	-	-	-
Critical Hdwy Stg 2	-	-	-	-	-	-	-	-	-	-	-	-
Follow-up Hdwy	-	-	-	-	-	-	-	-	3.92	-	-	3.92
Pot Cap-1 Maneuver	0	-	-	0	-	-	0	0	282	0	0	358
Stage 1	0	-	-	0	-	-	0	0	-	0	0	-
Stage 2	0	-	-	0	-	-	0	0	-	0	0	-
Platoon blocked, %	-	-	-	-	-	-	-	-	-	-	-	-
Mov Cap-1 Maneuver	-	-	-	-	-	-	-	-	282	-	-	358
Mov Cap-2 Maneuver	-	-	-	-	-	-	-	-	-	-	-	-
Stage 1	-	-	-	-	-	-	-	-	-	-	-	-
Stage 2	-	-	-	-	-	-	-	-	-	-	-	-

Approach	EB	WB	NB	SB
HCM Control Delay, s	0	0	68	19.8
HCM LOS			F	C

Minor Lane/Major Mvmt	NBLn1	EBT	EBR	WBT	WBR	SBLn1
Capacity (veh/h)	282	-	-	-	-	358
HCM Lane V/C Ratio	0.887	-	-	-	-	0.322
HCM Control Delay (s)	68	-	-	-	-	19.8
HCM Lane LOS	F	-	-	-	-	C
HCM 95th %tile Q(veh)	7.9	-	-	-	-	1.4

Lanes and Geometrics  
3: Parker Rd & Lincoln Ave

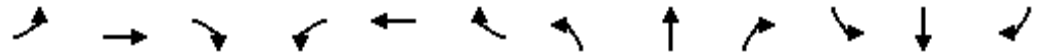

Lane Group	EBL	EBT	EBR	WBL	WBT	WBR	NBL	NBT	NBR	SBL	SBT	SBR
Lane Configurations												
Ideal Flow (vphpl)	1900	1900	1900	1900	1900	1900	1900	1900	1900	1900	1900	1900
Lane Width (ft)	12	12	12	12	12	12	12	12	12	12	12	12
Grade (%)		0%			0%			0%			0%	
Storage Length (ft)	275		0	200		0	500		0	400		0
Storage Lanes	2		1	2		1	2		1	2		1
Taper Length (ft)	25			25			25			25		
Lane Util. Factor	0.97	0.95	1.00	0.97	0.95	1.00	0.97	0.91	1.00	0.97	0.91	1.00
Ped Bike Factor												
Frt			0.850			0.850			0.850			0.850
Flt Protected	0.950			0.950			0.950			0.950		
Satd. Flow (prot)	3433	3539	1583	3433	3539	1583	3433	5085	1583	3433	5085	1583
Flt Permitted	0.950			0.950			0.950			0.950		
Satd. Flow (perm)	3433	3539	1583	3433	3539	1583	3433	5085	1583	3433	5085	1583
Right Turn on Red			Yes			Yes			Yes			Yes
Satd. Flow (RTOR)			259			265			151			206
Link Speed (mph)		30			30			30			30	
Link Distance (ft)		564			615			787			768	
Travel Time (s)		12.8			14.0			17.9			17.5	

Intersection Summary

Area Type: Other

Timings  
3: Parker Rd & Lincoln Ave

Lane Group	EBL	EBT	EBR	WBL	WBT	WBR	NBL	NBT	NBR	SBL	SBT	SBR
Lane Configurations												
Traffic Volume (vph)	576	645	365	149	416	244	423	1858	125	406	2248	340
Future Volume (vph)	576	645	365	149	416	244	423	1858	125	406	2248	340
Turn Type	Prot	NA	Perm	Prot	NA	Free	Prot	NA	Perm	Prot	NA	Free
Protected Phases	7	4		3	8		5	2		1	6	
Permitted Phases			4			Free			2			Free
Detector Phase	7	4	4	3	8		5	2	2	1	6	
Switch Phase												
Minimum Initial (s)	5.0	5.0	5.0	5.0	5.0		5.0	5.0	5.0	5.0	5.0	
Minimum Split (s)	10.0	35.0	35.0	10.0	35.0		15.0	30.5	30.5	10.0	30.5	
Total Split (s)	17.0	49.0	49.0	11.0	43.0		20.0	49.0	49.0	21.0	50.0	
Total Split (%)	13.1%	37.7%	37.7%	8.5%	33.1%		15.4%	37.7%	37.7%	16.2%	38.5%	
Yellow Time (s)	3.0	4.0	4.0	3.0	4.0		3.0	4.5	4.5	3.0	4.5	
All-Red Time (s)	2.0	2.0	2.0	2.0	2.0		2.0	2.0	2.0	2.0	2.0	
Lost Time Adjust (s)	0.0	0.0	0.0	0.0	0.0		0.0	0.0	0.0	0.0	0.0	
Total Lost Time (s)	5.0	6.0	6.0	5.0	6.0		5.0	6.5	6.5	5.0	6.5	
Lead/Lag	Lead	Lag	Lag	Lead	Lag		Lead	Lag	Lag	Lead	Lag	
Lead-Lag Optimize?	Yes	Yes	Yes	Yes	Yes		Yes	Yes	Yes	Yes	Yes	
Recall Mode	None	None	None	None	None		None	C-Max	C-Max	None	C-Max	
Act Effect Green (s)	12.0	35.4	35.4	6.0	29.4	130.0	22.6	44.5	44.5	21.6	43.5	130.0
Actuated g/C Ratio	0.09	0.27	0.27	0.05	0.23	1.00	0.17	0.34	0.34	0.17	0.33	1.00
v/c Ratio	1.98	0.73	0.64	1.03	0.57	0.17	0.77	1.16	0.21	0.77	1.44	0.23
Control Delay	481.8	58.7	29.8	138.3	46.8	0.2	61.4	118.2	4.4	62.1	233.4	0.3
Queue Delay	0.0	0.0	0.0	0.0	0.0	0.0	0.0	0.0	0.0	0.0	0.0	0.0
Total Delay	481.8	58.7	29.8	138.3	46.8	0.2	61.4	118.2	4.4	62.1	233.4	0.3
LOS	F	E	C	F	D	A	E	F	A	E	F	A
Approach Delay		205.7			49.6			102.3			183.7	
Approach LOS		F			D			F			F	

Intersection Summary

Cycle Length: 130  
 Actuated Cycle Length: 130  
 Offset: 0 (0%), Referenced to phase 2:NBT and 6:SBT, Start of Green  
 Natural Cycle: 145  
 Control Type: Actuated-Coordinated  
 Maximum v/c Ratio: 1.98  
 Intersection Signal Delay: 149.1  
 Intersection LOS: F  
 Intersection Capacity Utilization 102.2%  
 ICU Level of Service G  
 Analysis Period (min) 15

Splits and Phases: 3: Parker Rd & Lincoln Ave

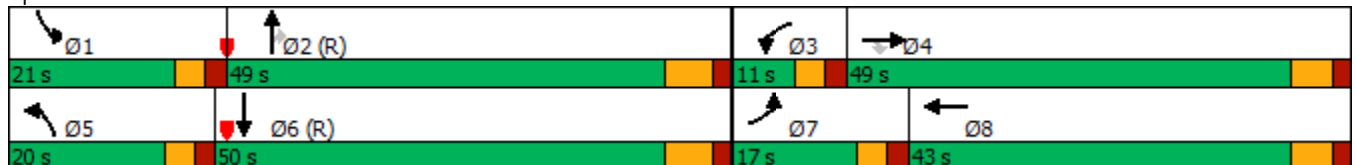

Queues  
3: Parker Rd & Lincoln Ave

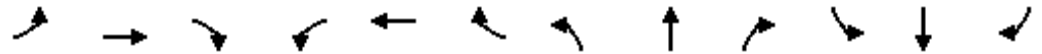

Lane Group	EBL	EBT	EBR	WBL	WBT	WBR	NBL	NBT	NBR	SBL	SBT	SBR
Lane Group Flow (vph)	626	701	397	162	452	265	460	2020	136	441	2443	370
v/c Ratio	1.98	0.73	0.64	1.03	0.57	0.17	0.77	1.16	0.21	0.77	1.44	0.23
Control Delay	481.8	58.7	29.8	138.3	46.8	0.2	61.4	118.2	4.4	62.1	233.4	0.3
Queue Delay	0.0	0.0	0.0	0.0	0.0	0.0	0.0	0.0	0.0	0.0	0.0	0.0
Total Delay	481.8	58.7	29.8	138.3	46.8	0.2	61.4	118.2	4.4	62.1	233.4	0.3
Queue Length 50th (ft)	~432	257	145	~74	178	0	193	~762	0	182	~1021	0
Queue Length 95th (ft)	m#466	m227	m122	#149	217	0	#345	#857	37	#315	#1111	0
Internal Link Dist (ft)		484			535			707			688	
Turn Bay Length (ft)	275			200			500			400		
Base Capacity (vph)	316	1170	696	158	1007	1583	597	1739	641	571	1701	1583
Starvation Cap Reductn	0	0	0	0	0	0	0	0	0	0	0	0
Spillback Cap Reductn	0	0	0	0	0	0	0	0	0	0	0	0
Storage Cap Reductn	0	0	0	0	0	0	0	0	0	0	0	0
Reduced v/c Ratio	1.98	0.60	0.57	1.03	0.45	0.17	0.77	1.16	0.21	0.77	1.44	0.23

Intersection Summary

- ~ Volume exceeds capacity, queue is theoretically infinite.  
Queue shown is maximum after two cycles.
- # 95th percentile volume exceeds capacity, queue may be longer.  
Queue shown is maximum after two cycles.
- m Volume for 95th percentile queue is metered by upstream signal.

HCM 6th Signalized Intersection Summary  
3: Parker Rd & Lincoln Ave

Lincoln & Dransfeldt  
09/27/2020

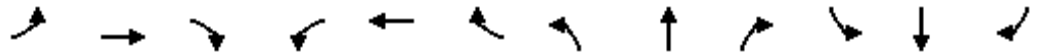

Movement	EBL	EBT	EBR	WBL	WBT	WBR	NBL	NBT	NBR	SBL	SBT	SBR
Lane Configurations	↔↔	↑↑	↗	↔↔	↑↑	↗	↔↔	↑↑↑	↗	↔↔	↑↑↑	↗
Traffic Volume (veh/h)	576	645	365	149	416	244	423	1858	125	406	2248	340
Future Volume (veh/h)	576	645	365	149	416	244	423	1858	125	406	2248	340
Initial Q (Qb), veh	0	0	0	0	0	0	0	0	0	0	0	0
Ped-Bike Adj(A_pbT)	1.00		1.00	1.00		1.00	1.00		1.00	1.00		1.00
Parking Bus, Adj	1.00	1.00	1.00	1.00	1.00	1.00	1.00	1.00	1.00	1.00	1.00	1.00
Work Zone On Approach		No			No			No			No	
Adj Sat Flow, veh/h/ln	1870	1870	1870	1870	1870	1870	1870	1870	1870	1870	1870	1870
Adj Flow Rate, veh/h	626	701	0	162	452	0	460	2020	0	441	2443	0
Peak Hour Factor	0.92	0.92	0.92	0.92	0.92	0.92	0.92	0.92	0.92	0.92	0.92	0.92
Percent Heavy Veh, %	2	2	2	2	2	2	2	2	2	2	2	2
Cap, veh/h	319	833		159	669		399	2162		425	2201	
Arrive On Green	0.12	0.31	0.00	0.05	0.19	0.00	0.12	0.42	0.00	0.12	0.43	0.00
Sat Flow, veh/h	3456	3554	1585	3456	3554	1585	3456	5106	1585	3456	5106	1585
Grp Volume(v), veh/h	626	701	0	162	452	0	460	2020	0	441	2443	0
Grp Sat Flow(s),veh/h/ln	1728	1777	1585	1728	1777	1585	1728	1702	1585	1728	1702	1585
Q Serve(g_s), s	12.0	23.9	0.0	6.0	15.4	0.0	15.0	49.1	0.0	16.0	56.0	0.0
Cycle Q Clear(g_c), s	12.0	23.9	0.0	6.0	15.4	0.0	15.0	49.1	0.0	16.0	56.0	0.0
Prop In Lane	1.00		1.00	1.00		1.00	1.00		1.00	1.00		1.00
Lane Grp Cap(c), veh/h	319	833		159	669		399	2162		425	2201	
V/C Ratio(X)	1.96	0.84		1.02	0.68		1.15	0.93		1.04	1.11	
Avail Cap(c_a), veh/h	319	1175		159	1011		399	2162		425	2201	
HCM Platoon Ratio	1.33	1.33	1.33	1.00	1.00	1.00	1.00	1.00	1.00	1.00	1.00	1.00
Upstream Filter(I)	1.00	1.00	0.00	1.00	1.00	0.00	1.00	1.00	0.00	1.00	1.00	0.00
Uniform Delay (d), s/veh	57.0	42.5	0.0	62.0	49.1	0.0	57.5	35.8	0.0	57.0	37.0	0.0
Incr Delay (d2), s/veh	444.3	4.0	0.0	75.4	1.2	0.0	94.1	9.1	0.0	53.5	56.6	0.0
Initial Q Delay(d3),s/veh	0.0	0.0	0.0	0.0	0.0	0.0	0.0	0.0	0.0	0.0	0.0	0.0
%ile BackOfQ(95%),veh/ln	39.4	15.8	0.0	7.7	11.3	0.0	18.4	29.4	0.0	15.6	47.4	0.0
Unsig. Movement Delay, s/veh												
LnGrp Delay(d),s/veh	501.3	46.5	0.0	137.4	50.3	0.0	151.6	44.8	0.0	110.5	93.6	0.0
LnGrp LOS	F	D		F	D		F	D		F	F	
Approach Vol, veh/h		1327	A		614	A		2480	A		2884	A
Approach Delay, s/veh		261.1			73.3			64.6			96.2	
Approach LOS		F			E			E			F	
Timer - Assigned Phs	1	2	3	4	5	6	7	8				
Phs Duration (G+Y+Rc), s	21.0	61.5	11.0	36.5	20.0	62.5	17.0	30.5				
Change Period (Y+Rc), s	5.0	6.5	5.0	6.0	5.0	6.5	5.0	6.0				
Max Green Setting (Gmax), s	16.0	42.5	6.0	43.0	15.0	43.5	12.0	37.0				
Max Q Clear Time (g_c+I1), s	18.0	51.1	8.0	25.9	17.0	58.0	14.0	17.4				
Green Ext Time (p_c), s	0.0	0.0	0.0	4.5	0.0	0.0	0.0	2.9				

Intersection Summary

HCM 6th Ctrl Delay	113.5
HCM 6th LOS	F

Notes

Unsignalized Delay for [NBR, EBR, WBR, SBR] is excluded from calculations of the approach delay and intersection delay.

Lanes and Geometrics  
4: Dransfeldt Rd & Lowe's Access

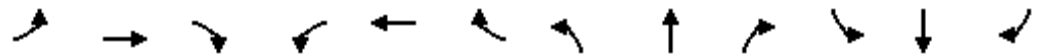

Lane Group	EBL	EBT	EBR	WBL	WBT	WBR	NBL	NBT	NBR	SBL	SBT	SBR
Lane Configurations		↕			↕	↗	↖	↕	↕	↖	↕	↕
Ideal Flow (vphpl)	1900	1900	1900	1900	1900	1900	1900	1900	1900	1900	1900	1900
Lane Width (ft)	12	12	12	12	12	12	12	12	12	12	12	12
Grade (%)		0%			0%			0%			0%	
Storage Length (ft)	100		0	100		0	125		0	100		0
Storage Lanes	0		0	0		1	1		0	1		0
Taper Length (ft)	25			25			25			25		
Lane Util. Factor	1.00	1.00	1.00	1.00	1.00	1.00	1.00	0.95	0.95	1.00	0.95	0.95
Ped Bike Factor		0.952				0.850		0.992			0.976	
Flt Protected		0.978			0.968		0.950			0.950		
Satd. Flow (prot)	0	1734	0	0	1803	1583	1770	3511	0	1770	3454	0
Flt Permitted		0.978			0.968		0.950			0.950		
Satd. Flow (perm)	0	1734	0	0	1803	1583	1770	3511	0	1770	3454	0
Link Speed (mph)		30			30			30			30	
Link Distance (ft)		400			302			232			351	
Travel Time (s)		9.1			6.9			5.3			8.0	

Intersection Summary

Area Type: Other

Intersection												
Int Delay, s/veh	39.1											
Movement	EBL	EBT	EBR	WBL	WBT	WBR	NBL	NBT	NBR	SBL	SBT	SBR
Lane Configurations		↕			↕	↕	↕	↕		↕	↕	
Traffic Vol, veh/h	44	19	35	37	18	129	16	626	37	278	314	60
Future Vol, veh/h	44	19	35	37	18	129	16	626	37	278	314	60
Conflicting Peds, #/hr	0	0	0	0	0	0	0	0	0	0	0	0
Sign Control	Stop	Stop	Stop	Stop	Stop	Stop	Free	Free	Free	Free	Free	Free
RT Channelized	-	-	None	-	-	None	-	-	None	-	-	None
Storage Length	-	-	-	-	-	0	125	-	-	100	-	-
Veh in Median Storage, #	-	0	-	-	0	-	-	0	-	-	0	-
Grade, %	-	0	-	-	0	-	-	0	-	-	0	-
Peak Hour Factor	92	92	92	92	92	92	92	92	92	92	92	92
Heavy Vehicles, %	2	2	2	2	2	2	2	2	2	2	2	2
Mvmt Flow	48	21	38	40	20	140	17	680	40	302	341	65

Major/Minor	Minor2		Minor1		Major1		Major2					
Conflicting Flow All	1362	1732	203	1519	1744	360	406	0	0	720	0	0
Stage 1	978	978	-	734	734	-	-	-	-	-	-	-
Stage 2	384	754	-	785	1010	-	-	-	-	-	-	-
Critical Hdwy	7.54	6.54	6.94	7.54	6.54	6.94	4.14	-	-	4.14	-	-
Critical Hdwy Stg 1	6.54	5.54	-	6.54	5.54	-	-	-	-	-	-	-
Critical Hdwy Stg 2	6.54	5.54	-	6.54	5.54	-	-	-	-	-	-	-
Follow-up Hdwy	3.52	4.02	3.32	3.52	4.02	3.32	2.22	-	-	2.22	-	-
Pot Cap-1 Maneuver	107	87	804	82	86	637	1149	-	-	877	-	-
Stage 1	269	327	-	378	424	-	-	-	-	-	-	-
Stage 2	611	415	-	352	316	-	-	-	-	-	-	-
Platoon blocked, %								-	-	-	-	-
Mov Cap-1 Maneuver	~ 45	56	804	41	56	637	1149	-	-	877	-	-
Mov Cap-2 Maneuver	~ 45	56	-	41	56	-	-	-	-	-	-	-
Stage 1	265	215	-	372	418	-	-	-	-	-	-	-
Stage 2	447	409	-	199	207	-	-	-	-	-	-	-





























Approach	EB	WB	NB	SB
HCM Control Delay, s\$	374.8	125.1	0.2	4.8
HCM LOS	F	F		

Minor Lane/Major Mvmt	NBL	NBT	NBR	EBLn1	WBLn1	WBLn2	SBL	SBT	SBR
Capacity (veh/h)	1149	-	-	72	45	637	877	-	-
HCM Lane V/C Ratio	0.015	-	-	1.479	1.329	0.22	0.345	-	-
HCM Control Delay (s)	8.2	-	-	\$ 374.8	\$ 389.8	12.2	11.2	-	-
HCM Lane LOS	A	-	-	F	F	B	B	-	-
HCM 95th %tile Q(veh)	0	-	-	8.8	5.7	0.8	1.5	-	-

Notes  
 -: Volume exceeds capacity    \$: Delay exceeds 300s    +: Computation Not Defined    \*: All major volume in platoon

Lanes and Geometrics  
1: Dransfeldt Rd & Lincoln Ave

Lincoln & Dransfeldt  
09/27/2020

												
Lane Group	EBL	EBT	EBR	WBL	WBT	WBR	NBL	NBT	NBR	SBL	SBT	SBR
Lane Configurations		  			  							
Ideal Flow (vphpl)	1900	1900	1900	1900	1900	1900	1900	1900	1900	1900	1900	1900
Lane Width (ft)	12	12	12	12	12	12	12	12	12	12	12	12
Grade (%)		0%			0%			0%			0%	
Storage Length (ft)	200		0	330		150	300		0	100		0
Storage Lanes	1		1	1		1	1		1	1		1
Taper Length (ft)	25			25			25			25		
Lane Util. Factor	1.00	0.91	1.00	1.00	0.91	1.00	0.95	0.95	1.00	1.00	1.00	1.00
Ped Bike Factor			0.850			0.850			0.850			0.850
Flt Protected	0.950			0.950			0.950	0.978		0.950		
Satd. Flow (prot)	1770	5085	1583	1770	5085	1583	1681	1731	1583	1770	1863	1583
Flt Permitted	0.088			0.120			0.950	0.978		0.950		
Satd. Flow (perm)	164	5085	1583	224	5085	1583	1681	1731	1583	1770	1863	1583
Right Turn on Red			Yes			Yes			Yes			Yes
Satd. Flow (RTOR)			220			117			229			122
Link Speed (mph)		30			30			30			30	
Link Distance (ft)		427			552			422			289	
Travel Time (s)		9.7			12.5			9.6			6.6	

Intersection Summary

Area Type: Other

Timings  
1: Dransfeldt Rd & Lincoln Ave

Lane Group	EBL	EBT	EBR	WBL	WBT	WBR	NBL	NBT	NBR	SBL	SBT	SBR
Lane Configurations												
Traffic Volume (vph)	51	1064	202	248	1599	6	171	65	211	4	98	64
Future Volume (vph)	51	1064	202	248	1599	6	171	65	211	4	98	64
Turn Type	pm+pt	NA	Perm	pm+pt	NA	Perm	Split	NA	Perm	Split	NA	Perm
Protected Phases	7	4		3	8		2	2		6	6	
Permitted Phases	4		4	8		8			2			6
Detector Phase	7	4	4	3	8	8	2	2	2	6	6	6
Switch Phase												
Minimum Initial (s)	3.0	10.0	10.0	4.0	10.0	10.0	5.0	5.0	5.0	5.0	5.0	5.0
Minimum Split (s)	10.0	40.0	40.0	9.5	35.0	35.0	35.0	35.0	35.0	35.0	35.0	35.0
Total Split (s)	28.0	45.0	45.0	30.0	47.0	47.0	29.0	29.0	29.0	26.0	26.0	26.0
Total Split (%)	21.5%	34.6%	34.6%	23.1%	36.2%	36.2%	22.3%	22.3%	22.3%	20.0%	20.0%	20.0%
Yellow Time (s)	4.0	4.0	4.0	3.0	3.0	3.0	3.5	3.5	3.5	3.5	3.5	3.5
All-Red Time (s)	2.0	2.0	2.0	2.0	2.0	2.0	2.0	2.0	2.0	2.0	2.0	2.0
Lost Time Adjust (s)	0.0	0.0	0.0	0.0	0.0	0.0	0.0	0.0	0.0	0.0	0.0	0.0
Total Lost Time (s)	6.0	6.0	6.0	5.0	5.0	5.0	5.5	5.5	5.5	5.5	5.5	5.5
Lead/Lag	Lead	Lag	Lag	Lead	Lag	Lag						
Lead-Lag Optimize?	Yes	Yes	Yes	Yes	Yes	Yes						
Recall Mode	None	None	None	None	None	None	C-Max	C-Max	C-Max	Max	Max	Max
Act Effct Green (s)	51.8	44.3	44.3	69.1	57.9	57.9	24.4	24.4	24.4	20.5	20.5	20.5
Actuated g/C Ratio	0.40	0.34	0.34	0.53	0.45	0.45	0.19	0.19	0.19	0.16	0.16	0.16
v/c Ratio	0.35	0.67	0.32	0.79	0.77	0.01	0.40	0.40	0.47	0.01	0.37	0.20
Control Delay	23.9	39.5	5.5	60.5	28.0	0.0	51.3	51.2	9.2	46.5	53.0	1.8
Queue Delay	0.0	0.0	0.0	0.0	0.0	0.0	0.0	0.0	0.0	0.0	0.0	0.0
Total Delay	23.9	39.5	5.5	60.5	28.0	0.0	51.3	51.2	9.2	46.5	53.0	1.8
LOS	C	D	A	E	C	A	D	D	A	D	D	A
Approach Delay		33.7			32.3			31.4			33.1	
Approach LOS		C			C			C			C	

Intersection Summary

Cycle Length: 130  
 Actuated Cycle Length: 130  
 Offset: 0 (0%), Referenced to phase 2:NBTL, Start of Green  
 Natural Cycle: 130  
 Control Type: Actuated-Coordinated  
 Maximum v/c Ratio: 0.79  
 Intersection Signal Delay: 32.7  
 Intersection LOS: C  
 Intersection Capacity Utilization 61.2%  
 ICU Level of Service B  
 Analysis Period (min) 15

Splits and Phases: 1: Dransfeldt Rd & Lincoln Ave

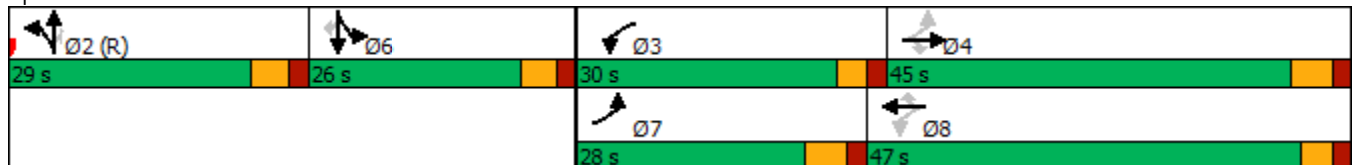

Queues

1: Dransfeldt Rd & Lincoln Ave

09/27/2020

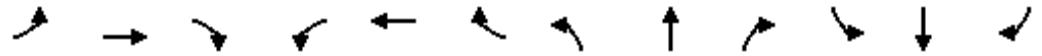

Lane Group	EBL	EBT	EBR	WBL	WBT	WBR	NBL	NBT	NBR	SBL	SBT	SBR
Lane Group Flow (vph)	55	1157	220	270	1738	7	126	131	229	4	107	70
v/c Ratio	0.35	0.67	0.32	0.79	0.77	0.01	0.40	0.40	0.47	0.01	0.37	0.20
Control Delay	23.9	39.5	5.5	60.5	28.0	0.0	51.3	51.2	9.2	46.5	53.0	1.8
Queue Delay	0.0	0.0	0.0	0.0	0.0	0.0	0.0	0.0	0.0	0.0	0.0	0.0
Total Delay	23.9	39.5	5.5	60.5	28.0	0.0	51.3	51.2	9.2	46.5	53.0	1.8
Queue Length 50th (ft)	22	301	0	180	259	0	100	104	0	3	82	0
Queue Length 95th (ft)	44	380	58	m232	m269	m0	167	172	72	14	141	4
Internal Link Dist (ft)		347			472			342			209	
Turn Bay Length (ft)	200			330		150	300			100		
Base Capacity (vph)	353	1732	684	415	2264	769	315	324	483	279	293	352
Starvation Cap Reductn	0	0	0	0	0	0	0	0	0	0	0	0
Spillback Cap Reductn	0	0	0	0	0	0	0	0	0	0	0	0
Storage Cap Reductn	0	0	0	0	0	0	0	0	0	0	0	0
Reduced v/c Ratio	0.16	0.67	0.32	0.65	0.77	0.01	0.40	0.40	0.47	0.01	0.37	0.20

Intersection Summary

m Volume for 95th percentile queue is metered by upstream signal.

HCM 6th Signalized Intersection Summary  
1: Dransfeldt Rd & Lincoln Ave

Lincoln & Dransfeldt  
09/27/2020



Movement	EBL	EBT	EBR	WBL	WBT	WBR	NBL	NBT	NBR	SBL	SBT	SBR
Lane Configurations	↶	↑↑↑	↷	↶	↑↑↑	↷	↶	↷	↷	↶	↷	↷
Traffic Volume (veh/h)	51	1064	202	248	1599	6	171	65	211	4	98	64
Future Volume (veh/h)	51	1064	202	248	1599	6	171	65	211	4	98	64
Initial Q (Qb), veh	0	0	0	0	0	0	0	0	0	0	0	0
Ped-Bike Adj(A_pbT)	1.00		1.00	1.00		1.00	1.00		1.00	1.00		1.00
Parking Bus, Adj	1.00	1.00	1.00	1.00	1.00	1.00	1.00	1.00	1.00	1.00	1.00	1.00
Work Zone On Approach		No			No			No			No	
Adj Sat Flow, veh/h/ln	1870	1870	1870	1870	1870	1870	1870	1870	1870	1870	1870	1870
Adj Flow Rate, veh/h	55	1157	220	270	1738	7	128	151	229	4	107	70
Peak Hour Factor	0.92	0.92	0.92	0.92	0.92	0.92	0.92	0.92	0.92	0.92	0.92	0.92
Percent Heavy Veh, %	2	2	2	2	2	2	2	2	2	2	2	2
Cap, veh/h	121	1390	431	301	1818	564	492	517	438	281	295	250
Arrive On Green	0.03	0.27	0.27	0.12	0.36	0.36	0.28	0.28	0.28	0.16	0.16	0.16
Sat Flow, veh/h	1781	5106	1585	1781	5106	1585	1781	1870	1585	1781	1870	1585
Grp Volume(v), veh/h	55	1157	220	270	1738	7	128	151	229	4	107	70
Grp Sat Flow(s),veh/h/ln	1781	1702	1585	1781	1702	1585	1781	1870	1585	1781	1870	1585
Q Serve(g_s), s	2.9	27.7	15.2	13.7	43.2	0.4	7.3	8.3	15.9	0.2	6.6	5.1
Cycle Q Clear(g_c), s	2.9	27.7	15.2	13.7	43.2	0.4	7.3	8.3	15.9	0.2	6.6	5.1
Prop In Lane	1.00		1.00	1.00		1.00	1.00		1.00	1.00		1.00
Lane Grp Cap(c), veh/h	121	1390	431	301	1818	564	492	517	438	281	295	250
V/C Ratio(X)	0.46	0.83	0.51	0.90	0.96	0.01	0.26	0.29	0.52	0.01	0.36	0.28
Avail Cap(c_a), veh/h	363	1532	476	421	1818	564	492	517	438	281	295	250
HCM Platoon Ratio	1.00	1.00	1.00	1.00	1.00	1.00	1.00	1.00	1.00	1.00	1.00	1.00
Upstream Filter(I)	1.00	1.00	1.00	1.00	1.00	1.00	1.00	1.00	1.00	1.00	1.00	1.00
Uniform Delay (d), s/veh	37.0	44.5	40.0	31.5	40.9	27.1	36.7	37.0	39.8	46.2	48.9	48.2
Incr Delay (d2), s/veh	2.7	3.8	0.9	16.9	12.3	0.0	1.3	1.4	4.4	0.1	3.4	2.8
Initial Q Delay(d3),s/veh	0.0	0.0	0.0	0.0	0.0	0.0	0.0	0.0	0.0	0.0	0.0	0.0
%ile BackOfQ(95%),veh/ln	2.4	17.9	10.1	11.7	27.3	0.3	6.1	7.2	11.0	0.2	6.1	4.0
Unsig. Movement Delay, s/veh												
LnGrp Delay(d),s/veh	39.7	48.3	40.9	48.4	53.2	27.1	38.0	38.5	44.2	46.3	52.3	51.0
LnGrp LOS	D	D	D	D	D	C	D	D	D	D	D	D
Approach Vol, veh/h		1432			2015			508			181	
Approach Delay, s/veh		46.8			52.4			40.9			51.7	
Approach LOS		D			D			D			D	
Timer - Assigned Phs		2	3	4		6	7	8				
Phs Duration (G+Y+Rc), s		41.4	21.2	41.4		26.0	10.3	52.3				
Change Period (Y+Rc), s		5.5	5.0	6.0		5.5	6.0	* 6				
Max Green Setting (Gmax), s		23.5	25.0	39.0		20.5	22.0	* 42				
Max Q Clear Time (g_c+I1), s		17.9	15.7	29.7		8.6	4.9	45.2				
Green Ext Time (p_c), s		1.1	0.5	5.7		0.6	0.1	0.0				

Intersection Summary

HCM 6th Ctrl Delay	49.1
HCM 6th LOS	D

Notes

- User approved pedestrian interval to be less than phase max green.
- User approved volume balancing among the lanes for turning movement.
- \* HCM 6th computational engine requires equal clearance times for the phases crossing the barrier.

Lanes and Geometrics  
2: Walgreens Access & Lincoln Ave

Lincoln & Dransfeldt  
09/27/2020

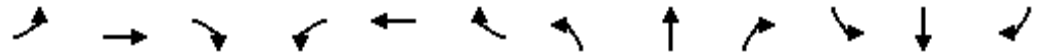

Lane Group	EBL	EBT	EBR	WBL	WBT	WBR	NBL	NBT	NBR	SBL	SBT	SBR
Lane Configurations		↑↑↑			↑↑↑				↑			↑
Ideal Flow (vphpl)	1900	1900	1900	1900	1900	1900	1900	1900	1900	1900	1900	1900
Lane Width (ft)	12	12	12	12	12	12	12	12	12	12	12	12
Grade (%)		0%			0%			0%			0%	
Storage Length (ft)	0		0	0		0	0		0	0		0
Storage Lanes	0		0	0		0	0		1	0		1
Taper Length (ft)	25			25			25			25		
Lane Util. Factor	1.00	0.91	0.91	1.00	0.91	0.91	1.00	1.00	1.00	1.00	1.00	1.00
Ped Bike Factor		0.996			0.996				0.865			0.865
Flt Protected												
Satd. Flow (prot)	0	5065	0	0	5065	0	0	0	1611	0	0	1611
Flt Permitted												
Satd. Flow (perm)	0	5065	0	0	5065	0	0	0	1611	0	0	1611
Link Speed (mph)		30			30			30				30
Link Distance (ft)		552			564			131				173
Travel Time (s)		12.5			12.8			3.0				3.9

Intersection Summary

Area Type: Other

Intersection												
Int Delay, s/veh	0.5											
Movement	EBL	EBT	EBR	WBL	WBT	WBR	NBL	NBT	NBR	SBL	SBT	SBR
Lane Configurations	↑↑↑			↑↑↑					↑			↑
Traffic Vol, veh/h	0	1247	33	0	1805	49	0	0	21	0	0	48
Future Vol, veh/h	0	1247	33	0	1805	49	0	0	21	0	0	48
Conflicting Peds, #/hr	0	0	0	0	0	0	0	0	0	0	0	0
Sign Control	Free	Free	Free	Free	Free	Free	Stop	Stop	Stop	Stop	Stop	Stop
RT Channelized	-	-	None	-	-	None	-	-	None	-	-	None
Storage Length	-	-	-	-	-	-	-	-	0	-	-	0
Veh in Median Storage, #	-	0	-	-	0	-	-	0	-	-	0	-
Grade, %	-	0	-	-	0	-	-	0	-	-	0	-
Peak Hour Factor	92	92	92	92	92	92	92	92	92	92	92	92
Heavy Vehicles, %	2	2	2	2	2	2	2	2	2	2	2	2
Mvmt Flow	0	1355	36	0	1962	53	0	0	23	0	0	52

Major/Minor	Major1		Major2		Minor1		Minor2					
Conflicting Flow All	-	0	0	-	-	0	-	-	696	-	-	1008
Stage 1	-	-	-	-	-	-	-	-	-	-	-	-
Stage 2	-	-	-	-	-	-	-	-	-	-	-	-
Critical Hdwy	-	-	-	-	-	-	-	-	7.14	-	-	7.14
Critical Hdwy Stg 1	-	-	-	-	-	-	-	-	-	-	-	-
Critical Hdwy Stg 2	-	-	-	-	-	-	-	-	-	-	-	-
Follow-up Hdwy	-	-	-	-	-	-	-	-	3.92	-	-	3.92
Pot Cap-1 Maneuver	0	-	-	0	-	-	0	0	329	0	0	205
Stage 1	0	-	-	0	-	-	0	0	-	0	0	-
Stage 2	0	-	-	0	-	-	0	0	-	0	0	-
Platoon blocked, %	-	-	-	-	-	-	-	-	-	-	-	-
Mov Cap-1 Maneuver	-	-	-	-	-	-	-	-	329	-	-	205
Mov Cap-2 Maneuver	-	-	-	-	-	-	-	-	-	-	-	-
Stage 1	-	-	-	-	-	-	-	-	-	-	-	-
Stage 2	-	-	-	-	-	-	-	-	-	-	-	-

Approach	EB	WB	NB	SB
HCM Control Delay, s	0	0	16.8	28.5
HCM LOS			C	D

Minor Lane/Major Mvmt	NBLn1	EBT	EBR	WBT	WBR	SBLn1
Capacity (veh/h)	329	-	-	-	-	205
HCM Lane V/C Ratio	0.069	-	-	-	-	0.255
HCM Control Delay (s)	16.8	-	-	-	-	28.5
HCM Lane LOS	C	-	-	-	-	D
HCM 95th %tile Q(veh)	0.2	-	-	-	-	1

Lanes and Geometrics  
3: Parker Rd & Lincoln Ave

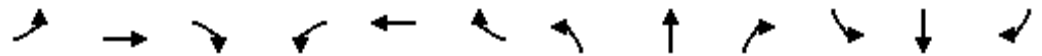

Lane Group	EBL	EBT	EBR	WBL	WBT	WBR	NBL	NBT	NBR	SBL	SBT	SBR
Lane Configurations												
Ideal Flow (vphpl)	1900	1900	1900	1900	1900	1900	1900	1900	1900	1900	1900	1900
Lane Width (ft)	12	12	12	12	12	12	12	12	12	12	12	12
Grade (%)	0%		0%				0%			0%		
Storage Length (ft)	275		150	200		0	500		0	400		0
Storage Lanes	2		1	2		1	2		1	2		1
Taper Length (ft)	25			25			25			25		
Lane Util. Factor	0.97	0.91	1.00	0.97	0.91	1.00	0.97	0.91	1.00	0.97	0.91	1.00
Ped Bike Factor	0.850			0.850			0.850			0.850		
Flt Protected	0.950			0.950			0.950			0.950		
Satd. Flow (prot)	3433	5085	1583	3433	5085	1583	3433	5085	1583	3433	5085	1583
Flt Permitted	0.950			0.950			0.950			0.950		
Satd. Flow (perm)	3433	5085	1583	3433	5085	1583	3433	5085	1583	3433	5085	1583
Right Turn on Red			Yes			Yes			Yes			Yes
Satd. Flow (RTOR)			258			515			151			206
Link Speed (mph)		30			30			30			30	
Link Distance (ft)		564			615			787			768	
Travel Time (s)		12.8			14.0			17.9			17.5	

Intersection Summary

Area Type: Other

Timings  
3: Parker Rd & Lincoln Ave

Lane Group	EBL	EBT	EBR	WBL	WBT	WBR	NBL	NBT	NBR	SBL	SBT	SBR
Lane Configurations												
Traffic Volume (vph)	369	565	334	224	903	560	550	2222	132	309	1862	401
Future Volume (vph)	369	565	334	224	903	560	550	2222	132	309	1862	401
Turn Type	Prot	NA	Perm	Prot	NA	Free	Prot	NA	Perm	Prot	NA	Free
Protected Phases	7	4		3	8		5	2		1	6	
Permitted Phases			4			Free			2			Free
Detector Phase	7	4	4	3	8		5	2	2	1	6	
Switch Phase												
Minimum Initial (s)	5.0	5.0	5.0	5.0	5.0		5.0	5.0	5.0	5.0	5.0	
Minimum Split (s)	10.0	35.0	35.0	10.0	35.0		15.0	30.5	30.5	10.0	30.5	
Total Split (s)	18.0	49.0	49.0	11.0	42.0		20.0	49.0	49.0	21.0	50.0	
Total Split (%)	13.8%	37.7%	37.7%	8.5%	32.3%		15.4%	37.7%	37.7%	16.2%	38.5%	
Yellow Time (s)	3.0	4.0	4.0	3.0	4.0		3.0	4.5	4.5	3.0	4.5	
All-Red Time (s)	2.0	2.0	2.0	2.0	2.0		2.0	2.0	2.0	2.0	2.0	
Lost Time Adjust (s)	0.0	0.0	0.0	0.0	0.0		0.0	0.0	0.0	0.0	0.0	
Total Lost Time (s)	5.0	6.0	6.0	5.0	6.0		5.0	6.5	6.5	5.0	6.5	
Lead/Lag	Lead	Lag	Lag	Lead	Lag		Lead	Lag	Lag	Lead	Lag	
Lead-Lag Optimize?	Yes	Yes	Yes	Yes	Yes		Yes	Yes	Yes	Yes	Yes	
Recall Mode	None	None	None	None	None		None	C-Max	C-Max	None	C-Max	
Act Effect Green (s)	13.0	39.7	39.7	6.0	32.7	130.0	18.3	45.8	45.8	16.1	43.5	130.0
Actuated g/C Ratio	0.10	0.31	0.31	0.05	0.25	1.00	0.14	0.35	0.35	0.12	0.33	1.00
v/c Ratio	1.17	0.40	0.55	1.54	0.77	0.38	1.24	1.35	0.22	0.79	1.19	0.28
Control Delay	151.5	70.0	48.0	311.0	49.4	0.7	169.0	195.5	5.0	69.6	130.2	0.4
Queue Delay	0.0	0.0	0.0	0.0	0.0	0.0	0.0	0.0	0.0	0.0	0.0	0.0
Total Delay	151.5	70.0	48.0	311.0	49.4	0.7	169.0	195.5	5.0	69.6	130.2	0.4
LOS	F	E	D	F	D	A	F	F	A	E	F	A
Approach Delay		87.9			67.9			181.9			102.7	
Approach LOS		F			E			F			F	

Intersection Summary

Cycle Length: 130  
 Actuated Cycle Length: 130  
 Offset: 0 (0%), Referenced to phase 2:NBT and 6:SBT, Start of Green  
 Natural Cycle: 145  
 Control Type: Actuated-Coordinated  
 Maximum v/c Ratio: 1.54  
 Intersection Signal Delay: 120.8  
 Intersection LOS: F  
 Intersection Capacity Utilization 98.5%  
 ICU Level of Service F  
 Analysis Period (min) 15

Splits and Phases: 3: Parker Rd & Lincoln Ave

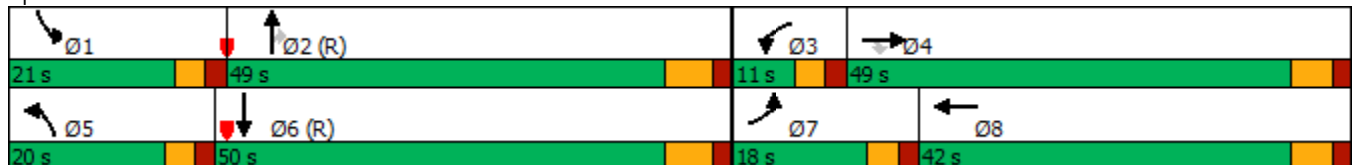

Queues  
3: Parker Rd & Lincoln Ave

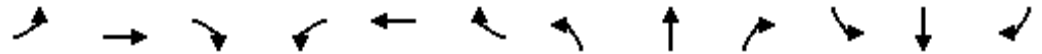

Lane Group	EBL	EBT	EBR	WBL	WBT	WBR	NBL	NBT	NBR	SBL	SBT	SBR
Lane Group Flow (vph)	401	614	363	243	982	609	598	2415	143	336	2024	436
v/c Ratio	1.17	0.40	0.55	1.54	0.77	0.38	1.24	1.35	0.22	0.79	1.19	0.28
Control Delay	151.5	70.0	48.0	311.0	49.4	0.7	169.0	195.5	5.0	69.6	130.2	0.4
Queue Delay	0.0	0.0	0.0	0.0	0.0	0.0	0.0	0.0	0.0	0.0	0.0	0.0
Total Delay	151.5	70.0	48.0	311.0	49.4	0.7	169.0	195.5	5.0	69.6	130.2	0.4
Queue Length 50th (ft)	~212	193	214	~147	280	0	~329	~1010	0	141	~752	0
Queue Length 95th (ft)	#320	239	330	#235	324	0	#479	#1106	42	#211	#847	0
Internal Link Dist (ft)		484			535			707			688	
Turn Bay Length (ft)	275		150	200			500			400		
Base Capacity (vph)	343	1681	696	158	1408	1583	483	1790	655	436	1701	1583
Starvation Cap Reductn	0	0	0	0	0	0	0	0	0	0	0	0
Spillback Cap Reductn	0	0	0	0	0	0	0	0	0	0	0	0
Storage Cap Reductn	0	0	0	0	0	0	0	0	0	0	0	0
Reduced v/c Ratio	1.17	0.37	0.52	1.54	0.70	0.38	1.24	1.35	0.22	0.77	1.19	0.28

Intersection Summary

- ~ Volume exceeds capacity, queue is theoretically infinite.  
Queue shown is maximum after two cycles.
- # 95th percentile volume exceeds capacity, queue may be longer.  
Queue shown is maximum after two cycles.

HCM 6th Signalized Intersection Summary  
3: Parker Rd & Lincoln Ave

Lincoln & Dransfeldt  
09/27/2020



Movement	EBL	EBT	EBR	WBL	WBT	WBR	NBL	NBT	NBR	SBL	SBT	SBR
Lane Configurations	↖↗	↑↑↑	↖	↖↗	↑↑↑	↖	↖↗	↑↑↑	↖	↖↗	↑↑↑	↖
Traffic Volume (veh/h)	369	565	334	224	903	560	550	2222	132	309	1862	401
Future Volume (veh/h)	369	565	334	224	903	560	550	2222	132	309	1862	401
Initial Q (Qb), veh	0	0	0	0	0	0	0	0	0	0	0	0
Ped-Bike Adj(A_pbT)	1.00		1.00	1.00		1.00	1.00		1.00	1.00		1.00
Parking Bus, Adj	1.00	1.00	1.00	1.00	1.00	1.00	1.00	1.00	1.00	1.00	1.00	1.00
Work Zone On Approach		No			No			No			No	
Adj Sat Flow, veh/h/ln	1870	1870	1870	1870	1870	1870	1870	1870	1870	1870	1870	1870
Adj Flow Rate, veh/h	401	614	0	243	982	0	598	2415	0	336	2024	0
Peak Hour Factor	0.92	0.92	0.92	0.92	0.92	0.92	0.92	0.92	0.92	0.92	0.92	0.92
Percent Heavy Veh, %	2	2	2	2	2	2	2	2	2	2	2	2
Cap, veh/h	346	1474		159	1199		399	1938		389	1923	
Arrive On Green	0.03	0.10	0.00	0.05	0.23	0.00	0.12	0.38	0.00	0.11	0.38	0.00
Sat Flow, veh/h	3456	5106	1585	3456	5106	1585	3456	5106	1585	3456	5106	1585
Grp Volume(v), veh/h	401	614	0	243	982	0	598	2415	0	336	2024	0
Grp Sat Flow(s),veh/h/ln	1728	1702	1585	1728	1702	1585	1728	1702	1585	1728	1702	1585
Q Serve(g_s), s	13.0	14.7	0.0	6.0	23.7	0.0	15.0	49.3	0.0	12.4	49.0	0.0
Cycle Q Clear(g_c), s	13.0	14.7	0.0	6.0	23.7	0.0	15.0	49.3	0.0	12.4	49.0	0.0
Prop In Lane	1.00		1.00	1.00		1.00	1.00		1.00	1.00		1.00
Lane Grp Cap(c), veh/h	346	1474		159	1199		399	1938		389	1923	
V/C Ratio(X)	1.16	0.42		1.52	0.82		1.50	1.25		0.86	1.05	
Avail Cap(c_a), veh/h	346	1689		159	1414		399	1938		425	1923	
HCM Platoon Ratio	0.33	0.33	0.33	1.00	1.00	1.00	1.00	1.00	1.00	1.00	1.00	1.00
Upstream Filter(I)	1.00	1.00	0.00	1.00	1.00	0.00	1.00	1.00	0.00	1.00	1.00	0.00
Uniform Delay (d), s/veh	62.9	48.5	0.0	62.0	47.1	0.0	57.5	40.3	0.0	56.7	40.5	0.0
Incr Delay (d2), s/veh	99.5	0.2	0.0	264.8	3.4	0.0	237.7	115.4	0.0	15.7	35.9	0.0
Initial Q Delay(d3),s/veh	0.0	0.0	0.0	0.0	0.0	0.0	0.0	0.0	0.0	0.0	0.0	0.0
%ile BackOfQ(95%),veh/ln	17.2	11.1	0.0	14.6	15.7	0.0	31.1	59.3	0.0	10.4	36.3	0.0
Unsig. Movement Delay, s/veh												
LnGrp Delay(d),s/veh	162.4	48.7	0.0	326.8	50.5	0.0	295.2	155.7	0.0	72.4	76.4	0.0
LnGrp LOS	F	D		F	D		F	F		E	F	
Approach Vol, veh/h		1015	A		1225	A		3013	A		2360	A
Approach Delay, s/veh		93.6			105.3			183.4			75.8	
Approach LOS		F			F			F			E	
Timer - Assigned Phs	1	2	3	4	5	6	7	8				
Phs Duration (G+Y+Rc), s	19.6	55.8	11.0	43.5	20.0	55.5	18.0	36.5				
Change Period (Y+Rc), s	5.0	6.5	5.0	6.0	5.0	6.5	5.0	6.0				
Max Green Setting (Gmax), s	16.0	42.5	6.0	43.0	15.0	43.5	13.0	36.0				
Max Q Clear Time (g_c+I1), s	14.4	51.3	8.0	16.7	17.0	51.0	15.0	25.7				
Green Ext Time (p_c), s	0.2	0.0	0.0	4.5	0.0	0.0	0.0	4.8				

Intersection Summary

HCM 6th Ctrl Delay	125.5
HCM 6th LOS	F

Notes

Unsignalized Delay for [NBR, EBR, WBR, SBR] is excluded from calculations of the approach delay and intersection delay.

Lanes and Geometrics  
 4: Dransfeldt Rd & Lowe's Access



Lane Group	EBL	EBR	NBL	NBT	SBT	SBR
Lane Configurations						
Ideal Flow (vphp)	1900	1900	1900	1900	1900	1900
Lane Width (ft)	12	12	12	12	12	12
Grade (%)	0%			0%	0%	
Storage Length (ft)	0	0	125			0
Storage Lanes	1	0	1			0
Taper Length (ft)	25		25			
Lane Util. Factor	1.00	1.00	1.00	0.95	1.00	1.00
Ped Bike Factor						
Frt	0.938				0.985	
Flt Protected	0.974		0.950			
Satd. Flow (prot)	1702	0	1770	3539	1835	0
Flt Permitted	0.974		0.950			
Satd. Flow (perm)	1702	0	1770	3539	1835	0
Link Speed (mph)	30			30	30	
Link Distance (ft)	400			232	422	
Travel Time (s)	9.1			5.3	9.6	

Intersection Summary

Area Type: Other

Intersection						
Int Delay, s/veh	1.3					
Movement	EBL	EBR	NBL	NBT	SBT	SBR
Lane Configurations						
Traffic Vol, veh/h	36	30	24	412	486	62
Future Vol, veh/h	36	30	24	412	486	62
Conflicting Peds, #/hr	0	0	0	0	0	0
Sign Control	Stop	Stop	Free	Free	Free	Free
RT Channelized	-	None	-	None	-	None
Storage Length	0	-	125	-	-	-
Veh in Median Storage, #	0	-	-	0	0	-
Grade, %	0	-	-	0	0	-
Peak Hour Factor	92	92	92	92	92	92
Heavy Vehicles, %	2	2	2	2	2	2
Mvmt Flow	39	33	26	448	528	67





























Major/Minor	Minor2	Major1	Major2			
Conflicting Flow All	838	562	595	0	-	0
Stage 1	562	-	-	-	-	-
Stage 2	276	-	-	-	-	-
Critical Hdwy	6.63	6.23	4.13	-	-	-
Critical Hdwy Stg 1	5.43	-	-	-	-	-
Critical Hdwy Stg 2	5.83	-	-	-	-	-
Follow-up Hdwy	3.519	3.319	2.219	-	-	-
Pot Cap-1 Maneuver	320	526	979	-	-	-
Stage 1	570	-	-	-	-	-
Stage 2	747	-	-	-	-	-
Platoon blocked, %				-	-	-
Mov Cap-1 Maneuver	311	526	979	-	-	-
Mov Cap-2 Maneuver	311	-	-	-	-	-
Stage 1	555	-	-	-	-	-
Stage 2	747	-	-	-	-	-

Approach	EB	NB	SB
HCM Control Delay, s	16.6	0.5	0
HCM LOS	C		

Minor Lane/Major Mvmt	NBL	NBT	EBLn1	SBT	SBR
Capacity (veh/h)	979	-	382	-	-
HCM Lane V/C Ratio	0.027	-	0.188	-	-
HCM Control Delay (s)	8.8	-	16.6	-	-
HCM Lane LOS	A	-	C	-	-
HCM 95th %tile Q(veh)	0.1	-	0.7	-	-

Lanes and Geometrics  
1: Dransfeldt Rd & Lincoln Ave

Lincoln & Dransfeldt  
09/27/2020

												
Lane Group	EBL	EBT	EBR	WBL	WBT	WBR	NBL	NBT	NBR	SBL	SBT	SBR
Lane Configurations		  			  							
Ideal Flow (vphpl)	1900	1900	1900	1900	1900	1900	1900	1900	1900	1900	1900	1900
Lane Width (ft)	12	12	12	12	12	12	12	12	12	12	12	12
Grade (%)		0%			0%			0%			0%	
Storage Length (ft)	200		0	330		150	300		0	100		0
Storage Lanes	1		1	1		1	1		1	1		1
Taper Length (ft)	25			25			25			25		
Lane Util. Factor	1.00	0.91	1.00	1.00	0.91	1.00	0.95	0.95	1.00	1.00	1.00	1.00
Ped Bike Factor			0.850			0.850			0.850			0.850
Flt Protected	0.950			0.950			0.950	0.986		0.950		
Satd. Flow (prot)	1770	5085	1583	1770	5085	1583	1681	1745	1583	1770	1863	1583
Flt Permitted	0.098			0.093			0.950	0.986		0.950		
Satd. Flow (perm)	183	5085	1583	173	5085	1583	1681	1745	1583	1770	1863	1583
Right Turn on Red			Yes			Yes			Yes			Yes
Satd. Flow (RTOR)			175			117			448			126
Link Speed (mph)		30			30			30			30	
Link Distance (ft)		427			552			422			289	
Travel Time (s)		9.7			12.5			9.6			6.6	

Intersection Summary

Area Type: Other

Timings  
1: Dransfeldt Rd & Lincoln Ave

Lane Group	EBL	EBT	EBR	WBL	WBT	WBR	NBL	NBT	NBR	SBL	SBT	SBR
Lane Configurations												
Traffic Volume (vph)	116	1504	217	267	1128	27	322	183	440	21	91	116
Future Volume (vph)	116	1504	217	267	1128	27	322	183	440	21	91	116
Turn Type	pm+pt	NA	Perm	pm+pt	NA	Perm	Split	NA	Perm	Split	NA	Perm
Protected Phases	7	4		3	8		2	2		6	6	
Permitted Phases	4		4	8		8			2			6
Detector Phase	7	4	4	3	8	8	2	2	2	6	6	6
Switch Phase												
Minimum Initial (s)	3.0	10.0	10.0	4.0	10.0	10.0	5.0	5.0	5.0	5.0	5.0	5.0
Minimum Split (s)	10.0	40.0	40.0	9.5	35.0	35.0	35.0	35.0	35.0	35.0	35.0	35.0
Total Split (s)	15.0	47.0	47.0	16.0	48.0	48.0	36.0	36.0	36.0	31.0	31.0	31.0
Total Split (%)	11.5%	36.2%	36.2%	12.3%	36.9%	36.9%	27.7%	27.7%	27.7%	23.8%	23.8%	23.8%
Yellow Time (s)	4.0	4.0	4.0	3.0	3.0	3.0	3.5	3.5	3.5	3.5	3.5	3.5
All-Red Time (s)	2.0	2.0	2.0	2.0	2.0	2.0	2.0	2.0	2.0	2.0	2.0	2.0
Lost Time Adjust (s)	0.0	0.0	0.0	0.0	0.0	0.0	0.0	0.0	0.0	0.0	0.0	0.0
Total Lost Time (s)	6.0	6.0	6.0	5.0	5.0	5.0	5.5	5.5	5.5	5.5	5.5	5.5
Lead/Lag	Lead	Lag	Lag	Lead	Lag	Lag						
Lead-Lag Optimize?	Yes	Yes	Yes	Yes	Yes	Yes						
Recall Mode	None	None	None	None	None	None	C-Max	C-Max	C-Max	Max	Max	Max
Act Effct Green (s)	49.8	41.0	41.0	54.2	43.2	43.2	30.5	30.5	30.5	25.5	25.5	25.5
Actuated g/C Ratio	0.38	0.32	0.32	0.42	0.33	0.33	0.23	0.23	0.23	0.20	0.20	0.20
v/c Ratio	0.71	1.02	0.38	1.41	0.73	0.05	0.68	0.68	0.67	0.07	0.27	0.31
Control Delay	47.4	71.5	11.6	240.6	41.9	1.6	55.4	55.1	10.3	43.3	46.7	9.4
Queue Delay	0.0	0.0	0.0	0.0	0.0	0.0	0.0	0.0	0.0	0.0	0.0	0.0
Total Delay	47.4	71.5	11.6	240.6	41.9	1.6	55.4	55.1	10.3	43.3	46.7	9.4
LOS	D	E	B	F	D	A	E	E	B	D	D	A
Approach Delay		62.9			78.5			34.3			27.4	
Approach LOS		E			E			C			C	

Intersection Summary

Cycle Length: 130  
 Actuated Cycle Length: 130  
 Offset: 0 (0%), Referenced to phase 2:NBTL, Start of Green  
 Natural Cycle: 140  
 Control Type: Actuated-Coordinated  
 Maximum v/c Ratio: 1.41  
 Intersection Signal Delay: 60.0  
 Intersection LOS: E  
 Intersection Capacity Utilization 78.0%  
 ICU Level of Service D  
 Analysis Period (min) 15

Splits and Phases: 1: Dransfeldt Rd & Lincoln Ave

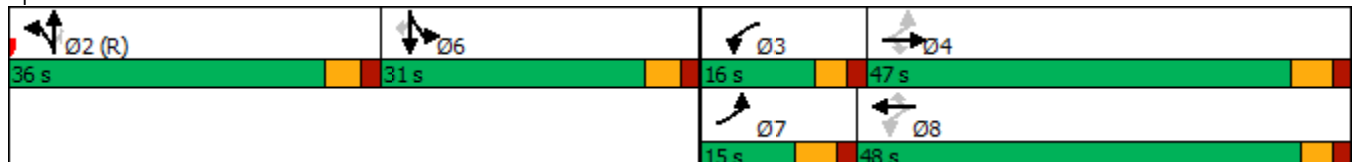

Queues

1: Dransfeldt Rd & Lincoln Ave

09/27/2020



Lane Group	EBL	EBT	EBR	WBL	WBT	WBR	NBL	NBT	NBR	SBL	SBT	SBR
Lane Group Flow (vph)	126	1635	236	290	1226	29	269	280	478	23	99	126
v/c Ratio	0.71	1.02	0.38	1.41	0.73	0.05	0.68	0.68	0.67	0.07	0.27	0.31
Control Delay	47.4	71.5	11.6	240.6	41.9	1.6	55.4	55.1	10.3	43.3	46.7	9.4
Queue Delay	0.0	0.0	0.0	0.0	0.0	0.0	0.0	0.0	0.0	0.0	0.0	0.0
Total Delay	47.4	71.5	11.6	240.6	41.9	1.6	55.4	55.1	10.3	43.3	46.7	9.4
Queue Length 50th (ft)	63	~534	37	~283	249	0	218	228	20	16	72	0
Queue Length 95th (ft)	#143	#631	105	m#363	m248	m4	324	335	129	42	125	54
Internal Link Dist (ft)		347			472			342			209	
Turn Bay Length (ft)	200			330		150	300			100		
Base Capacity (vph)	180	1603	619	206	1689	603	394	409	714	347	365	411
Starvation Cap Reductn	0	0	0	0	0	0	0	0	0	0	0	0
Spillback Cap Reductn	0	0	0	0	0	0	0	0	0	0	0	0
Storage Cap Reductn	0	0	0	0	0	0	0	0	0	0	0	0
Reduced v/c Ratio	0.70	1.02	0.38	1.41	0.73	0.05	0.68	0.68	0.67	0.07	0.27	0.31

Intersection Summary

- ~ Volume exceeds capacity, queue is theoretically infinite.  
Queue shown is maximum after two cycles.
- # 95th percentile volume exceeds capacity, queue may be longer.  
Queue shown is maximum after two cycles.
- m Volume for 95th percentile queue is metered by upstream signal.

# HCM 6th Signalized Intersection Summary

Lincoln & Dransfeldt

## 1: Dransfeldt Rd & Lincoln Ave

09/27/2020

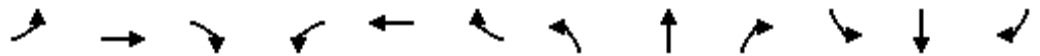

Movement	EBL	EBT	EBR	WBL	WBT	WBR	NBL	NBT	NBR	SBL	SBT	SBR
Lane Configurations	↶	↷↷↷	↷	↶	↷↷↷	↷	↶	↷	↷	↶	↷	↷
Traffic Volume (veh/h)	116	1504	217	267	1128	27	322	183	440	21	91	116
Future Volume (veh/h)	116	1504	217	267	1128	27	322	183	440	21	91	116
Initial Q (Qb), veh	0	0	0	0	0	0	0	0	0	0	0	0
Ped-Bike Adj(A_pbT)	1.00		1.00	1.00		1.00	1.00		1.00	1.00		1.00
Parking Bus, Adj	1.00	1.00	1.00	1.00	1.00	1.00	1.00	1.00	1.00	1.00	1.00	1.00
Work Zone On Approach		No			No			No			No	
Adj Sat Flow, veh/h/ln	1870	1870	1870	1870	1870	1870	1870	1870	1870	1870	1870	1870
Adj Flow Rate, veh/h	126	1635	236	290	1226	29	274	305	478	23	99	126
Peak Hour Factor	0.92	0.92	0.92	0.92	0.92	0.92	0.92	0.92	0.92	0.92	0.92	0.92
Percent Heavy Veh, %	2	2	2	2	2	2	2	2	2	2	2	2
Cap, veh/h	219	1610	500	206	1685	523	418	439	372	349	367	311
Arrive On Green	0.06	0.32	0.32	0.08	0.33	0.33	0.23	0.23	0.23	0.20	0.20	0.20
Sat Flow, veh/h	1781	5106	1585	1781	5106	1585	1781	1870	1585	1781	1870	1585
Grp Volume(v), veh/h	126	1635	236	290	1226	29	274	305	478	23	99	126
Grp Sat Flow(s),veh/h/ln	1781	1702	1585	1781	1702	1585	1781	1870	1585	1781	1870	1585
Q Serve(g_s), s	6.2	41.0	15.6	11.0	27.5	1.6	18.1	19.4	30.5	1.4	5.8	9.0
Cycle Q Clear(g_c), s	6.2	41.0	15.6	11.0	27.5	1.6	18.1	19.4	30.5	1.4	5.8	9.0
Prop In Lane	1.00		1.00	1.00		1.00	1.00		1.00	1.00		1.00
Lane Grp Cap(c), veh/h	219	1610	500	206	1685	523	418	439	372	349	367	311
V/C Ratio(X)	0.58	1.02	0.47	1.41	0.73	0.06	0.66	0.70	1.29	0.07	0.27	0.41
Avail Cap(c_a), veh/h	231	1610	500	206	1689	524	418	439	372	349	367	311
HCM Platoon Ratio	1.00	1.00	1.00	1.00	1.00	1.00	1.00	1.00	1.00	1.00	1.00	1.00
Upstream Filter(I)	1.00	1.00	1.00	1.00	1.00	1.00	1.00	1.00	1.00	1.00	1.00	1.00
Uniform Delay (d), s/veh	30.6	44.5	35.8	37.1	38.4	29.7	45.0	45.5	49.7	42.6	44.3	45.6
Incr Delay (d2), s/veh	3.2	26.3	0.7	209.5	1.6	0.0	7.8	8.8	147.4	0.4	1.8	3.9
Initial Q Delay(d3),s/veh	0.0	0.0	0.0	0.0	0.0	0.0	0.0	0.0	0.0	0.0	0.0	0.0
%ile BackOfQ(95%),veh/ln	5.1	28.9	10.2	25.7	17.3	1.1	13.8	15.3	40.8	1.2	5.2	7.0
Unsig. Movement Delay, s/veh												
LnGrp Delay(d),s/veh	33.8	70.8	36.5	246.6	40.0	29.8	52.8	54.3	197.2	42.9	46.2	49.5
LnGrp LOS	C	F	D	F	D	C	D	D	F	D	D	D
Approach Vol, veh/h		1997			1545			1057			248	
Approach Delay, s/veh		64.4			78.6			118.5			47.6	
Approach LOS		E			E			F			D	
Timer - Assigned Phs		2	3	4		6	7	8				
Phs Duration (G+Y+Rc), s		36.0	16.0	47.0		31.0	14.1	48.9				
Change Period (Y+Rc), s		5.5	5.0	6.0		5.5	6.0	* 6				
Max Green Setting (Gmax), s		30.5	11.0	41.0		25.5	9.0	* 43				
Max Q Clear Time (g_c+I1), s		32.5	13.0	43.0		11.0	8.2	29.5				
Green Ext Time (p_c), s		0.0	0.0	0.0		0.8	0.0	7.2				

### Intersection Summary

HCM 6th Ctrl Delay	79.9
HCM 6th LOS	E

### Notes

- User approved pedestrian interval to be less than phase max green.
- User approved volume balancing among the lanes for turning movement.
- \* HCM 6th computational engine requires equal clearance times for the phases crossing the barrier.

Lanes and Geometrics  
2: Walgreens Access & Lincoln Ave

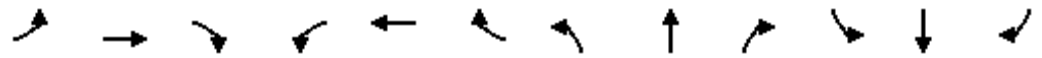

Lane Group	EBL	EBT	EBR	WBL	WBT	WBR	NBL	NBT	NBR	SBL	SBT	SBR
Lane Configurations		↑↑↑			↑↑↑				↑			↑
Ideal Flow (vphpl)	1900	1900	1900	1900	1900	1900	1900	1900	1900	1900	1900	1900
Lane Width (ft)	12	12	12	12	12	12	12	12	12	12	12	12
Grade (%)		0%			0%			0%			0%	
Storage Length (ft)	0		0	0		0	0		0	0		0
Storage Lanes	0		0	0		0	0		1	0		1
Taper Length (ft)	25			25			25			25		
Lane Util. Factor	1.00	0.91	0.91	1.00	0.91	0.91	1.00	1.00	1.00	1.00	1.00	1.00
Ped Bike Factor												
Frt		0.994			0.988				0.865			0.865
Flt Protected												
Satd. Flow (prot)	0	5055	0	0	5024	0	0	0	1611	0	0	1611
Flt Permitted												
Satd. Flow (perm)	0	5055	0	0	5024	0	0	0	1611	0	0	1611
Link Speed (mph)		30			30			30				30
Link Distance (ft)		552			564			131				173
Travel Time (s)		12.5			12.8			3.0				3.9

Intersection Summary

Area Type: Other

Intersection												
Int Delay, s/veh	1.9											
Movement	EBL	EBT	EBR	WBL	WBT	WBR	NBL	NBT	NBR	SBL	SBT	SBR
Lane Configurations	↑↑↑			↑↑↑					↑			↑
Traffic Vol, veh/h	0	1890	74	0	1274	108	0	0	64	0	0	149
Future Vol, veh/h	0	1890	74	0	1274	108	0	0	64	0	0	149
Conflicting Peds, #/hr	0	0	0	0	0	0	0	0	0	0	0	0
Sign Control	Free	Free	Free	Free	Free	Free	Stop	Stop	Stop	Stop	Stop	Stop
RT Channelized	-	-	None	-	-	None	-	-	None	-	-	None
Storage Length	-	-	-	-	-	-	-	-	0	-	-	0
Veh in Median Storage, #	-	0	-	-	0	-	-	0	-	-	0	-
Grade, %	-	0	-	-	0	-	-	0	-	-	0	-
Peak Hour Factor	92	92	92	92	92	92	92	92	92	92	92	92
Heavy Vehicles, %	2	2	2	2	2	2	2	2	2	2	2	2
Mvmt Flow	0	2054	80	0	1385	117	0	0	70	0	0	162

Major/Minor	Major1		Major2		Minor1		Minor2					
Conflicting Flow All	-	0	0	-	-	0	-	-	1067	-	-	751
Stage 1	-	-	-	-	-	-	-	-	-	-	-	-
Stage 2	-	-	-	-	-	-	-	-	-	-	-	-
Critical Hdwy	-	-	-	-	-	-	-	-	7.14	-	-	7.14
Critical Hdwy Stg 1	-	-	-	-	-	-	-	-	-	-	-	-
Critical Hdwy Stg 2	-	-	-	-	-	-	-	-	-	-	-	-
Follow-up Hdwy	-	-	-	-	-	-	-	-	3.92	-	-	3.92
Pot Cap-1 Maneuver	0	-	-	0	-	-	0	0	187	0	0	303
Stage 1	0	-	-	0	-	-	0	0	-	0	0	-
Stage 2	0	-	-	0	-	-	0	0	-	0	0	-
Platoon blocked, %	-	-	-	-	-	-	-	-	-	-	-	-
Mov Cap-1 Maneuver	-	-	-	-	-	-	-	-	187	-	-	303
Mov Cap-2 Maneuver	-	-	-	-	-	-	-	-	-	-	-	-
Stage 1	-	-	-	-	-	-	-	-	-	-	-	-
Stage 2	-	-	-	-	-	-	-	-	-	-	-	-

Approach	EB	WB	NB	SB
HCM Control Delay, s	0	0	35.2	29.7
HCM LOS			E	D

Minor Lane/Major Mvmt	NBLn1	EBT	EBR	WBT	WBR	SBLn1
Capacity (veh/h)	187	-	-	-	-	303
HCM Lane V/C Ratio	0.372	-	-	-	-	0.535
HCM Control Delay (s)	35.2	-	-	-	-	29.7
HCM Lane LOS	E	-	-	-	-	D
HCM 95th %tile Q(veh)	1.6	-	-	-	-	3

Lanes and Geometrics  
3: Parker Rd & Lincoln Ave

Lincoln & Dransfeldt

09/27/2020



Lane Group	EBL	EBT	EBR	WBL	WBT	WBR	NBL	NBT	NBR	SBL	SBT	SBR
Lane Configurations												
Ideal Flow (vphpl)	1900	1900	1900	1900	1900	1900	1900	1900	1900	1900	1900	1900
Lane Width (ft)	12	12	12	12	12	12	12	12	12	12	12	12
Grade (%)		0%			0%			0%			0%	
Storage Length (ft)	275		150	200		0	500		0	400		0
Storage Lanes	2		1	2		1	2		1	2		1
Taper Length (ft)	25			25			25			25		
Lane Util. Factor	0.97	0.91	1.00	0.97	0.91	1.00	0.97	0.91	1.00	0.97	0.91	1.00
Ped Bike Factor												
Frt			0.850			0.850			0.850			0.850
Flt Protected	0.950			0.950			0.950			0.950		
Satd. Flow (prot)	3433	5085	1583	3433	5085	1583	3433	5085	1583	3433	5085	1583
Flt Permitted	0.950			0.950			0.950			0.950		
Satd. Flow (perm)	3433	5085	1583	3433	5085	1583	3433	5085	1583	3433	5085	1583
Right Turn on Red			Yes			Yes			Yes			Yes
Satd. Flow (RTOR)			185			372			151			206
Link Speed (mph)		30			30			30			30	
Link Distance (ft)		564			615			787			768	
Travel Time (s)		12.8			14.0			17.9			17.5	

Intersection Summary

Area Type: Other

Timings  
3: Parker Rd & Lincoln Ave

Lane Group	EBL	EBT	EBR	WBL	WBT	WBR	NBL	NBT	NBR	SBL	SBT	SBR
Lane Configurations												
Traffic Volume (vph)	718	814	422	208	493	342	502	2602	175	569	3149	386
Future Volume (vph)	718	814	422	208	493	342	502	2602	175	569	3149	386
Turn Type	Prot	NA	Perm	Prot	NA	Free	Prot	NA	Perm	Prot	NA	Free
Protected Phases	7	4		3	8		5	2		1	6	
Permitted Phases			4			Free			2			Free
Detector Phase	7	4	4	3	8		5	2	2	1	6	
Switch Phase												
Minimum Initial (s)	5.0	5.0	5.0	5.0	5.0		5.0	5.0	5.0	5.0	5.0	
Minimum Split (s)	10.0	35.0	35.0	10.0	35.0		15.0	30.5	30.5	10.0	30.5	
Total Split (s)	20.0	41.0	41.0	14.0	35.0		18.0	58.0	58.0	17.0	57.0	
Total Split (%)	15.4%	31.5%	31.5%	10.8%	26.9%		13.8%	44.6%	44.6%	13.1%	43.8%	
Yellow Time (s)	3.0	4.0	4.0	3.0	4.0		3.0	4.5	4.5	3.0	4.5	
All-Red Time (s)	2.0	2.0	2.0	2.0	2.0		2.0	2.0	2.0	2.0	2.0	
Lost Time Adjust (s)	0.0	0.0	0.0	0.0	0.0		0.0	0.0	0.0	0.0	0.0	
Total Lost Time (s)	5.0	6.0	6.0	5.0	6.0		5.0	6.5	6.5	5.0	6.5	
Lead/Lag	Lead	Lag	Lag	Lead	Lag		Lead	Lag	Lag	Lead	Lag	
Lead-Lag Optimize?	Yes	Yes	Yes	Yes	Yes		Yes	Yes	Yes	Yes	Yes	
Recall Mode	None	None	None	None	None		None	C-Max	C-Max	None	C-Max	
Act Effect Green (s)	15.0	32.8	32.8	9.0	26.8	130.0	15.2	51.5	51.5	14.2	50.5	130.0
Actuated g/C Ratio	0.12	0.25	0.25	0.07	0.21	1.00	0.12	0.40	0.40	0.11	0.39	1.00
v/c Ratio	1.97	0.69	0.85	0.95	0.51	0.23	1.36	1.40	0.26	1.65	1.73	0.27
Control Delay	471.4	75.1	65.0	107.6	47.3	0.3	221.4	217.1	7.6	341.0	359.9	0.4
Queue Delay	0.0	0.0	0.0	0.0	0.0	0.0	0.0	0.0	0.0	0.0	0.0	0.0
Total Delay	471.4	75.1	65.0	107.6	47.3	0.3	221.4	217.1	7.6	341.0	359.9	0.4
LOS	F	E	E	F	D	A	F	F	A	F	F	A
Approach Delay		218.5			43.9			206.6			323.5	
Approach LOS		F			D			F			F	

Intersection Summary

Cycle Length: 130  
 Actuated Cycle Length: 130  
 Offset: 0 (0%), Referenced to phase 2:NBT and 6:SBT, Start of Green  
 Natural Cycle: 145  
 Control Type: Actuated-Coordinated  
 Maximum v/c Ratio: 1.97  
 Intersection Signal Delay: 238.7  
 Intersection LOS: F  
 Intersection Capacity Utilization 123.9%  
 ICU Level of Service H  
 Analysis Period (min) 15

Splits and Phases: 3: Parker Rd & Lincoln Ave

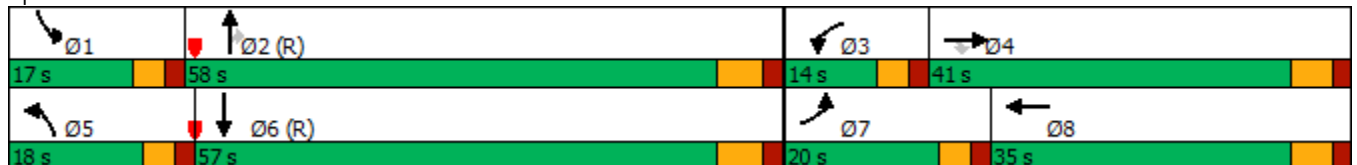

Queues  
3: Parker Rd & Lincoln Ave

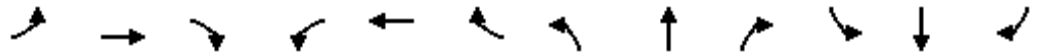

Lane Group	EBL	EBT	EBR	WBL	WBT	WBR	NBL	NBT	NBR	SBL	SBT	SBR
Lane Group Flow (vph)	780	885	459	226	536	372	546	2828	190	618	3423	420
v/c Ratio	1.97	0.69	0.85	0.95	0.51	0.23	1.36	1.40	0.26	1.65	1.73	0.27
Control Delay	471.4	75.1	65.0	107.6	47.3	0.3	221.4	217.1	7.6	341.0	359.9	0.4
Queue Delay	0.0	0.0	0.0	0.0	0.0	0.0	0.0	0.0	0.0	0.0	0.0	0.0
Total Delay	471.4	75.1	65.0	107.6	47.3	0.3	221.4	217.1	7.6	341.0	359.9	0.4
Queue Length 50th (ft)	~540	282	306	99	145	0	~337	~1167	20	~414	~1561	0
Queue Length 95th (ft)	m#564	m293	m337	#181	183	0	#452	#1251	70	#534	#1634	0
Internal Link Dist (ft)		484			535			707			688	
Turn Bay Length (ft)	275		150	200			500			400		
Base Capacity (vph)	396	1369	561	237	1134	1583	400	2014	718	374	1975	1583
Starvation Cap Reductn	0	0	0	0	0	0	0	0	0	0	0	0
Spillback Cap Reductn	0	0	0	0	0	0	0	0	0	0	0	0
Storage Cap Reductn	0	0	0	0	0	0	0	0	0	0	0	0
Reduced v/c Ratio	1.97	0.65	0.82	0.95	0.47	0.23	1.36	1.40	0.26	1.65	1.73	0.27

Intersection Summary

- ~ Volume exceeds capacity, queue is theoretically infinite.  
Queue shown is maximum after two cycles.
- # 95th percentile volume exceeds capacity, queue may be longer.  
Queue shown is maximum after two cycles.
- m Volume for 95th percentile queue is metered by upstream signal.

HCM 6th Signalized Intersection Summary  
3: Parker Rd & Lincoln Ave

Lincoln & Dransfeldt  
09/27/2020



Movement	EBL	EBT	EBR	WBL	WBT	WBR	NBL	NBT	NBR	SBL	SBT	SBR
Lane Configurations												
Traffic Volume (veh/h)	718	814	422	208	493	342	502	2602	175	569	3149	386
Future Volume (veh/h)	718	814	422	208	493	342	502	2602	175	569	3149	386
Initial Q (Qb), veh	0	0	0	0	0	0	0	0	0	0	0	0
Ped-Bike Adj(A_pbT)	1.00		1.00	1.00		1.00	1.00		1.00	1.00		1.00
Parking Bus, Adj	1.00	1.00	1.00	1.00	1.00	1.00	1.00	1.00	1.00	1.00	1.00	1.00
Work Zone On Approach		No			No			No			No	
Adj Sat Flow, veh/h/ln	1870	1870	1870	1870	1870	1870	1870	1870	1870	1870	1870	1870
Adj Flow Rate, veh/h	780	885	0	226	536	0	546	2828	0	618	3423	0
Peak Hour Factor	0.92	0.92	0.92	0.92	0.92	0.92	0.92	0.92	0.92	0.92	0.92	0.92
Percent Heavy Veh, %	2	2	2	2	2	2	2	2	2	2	2	2
Cap, veh/h	399	1127		239	891		346	2271		319	2232	
Arrive On Green	0.04	0.07	0.00	0.07	0.17	0.00	0.10	0.44	0.00	0.09	0.44	0.00
Sat Flow, veh/h	3456	5106	1585	3456	5106	1585	3456	5106	1585	3456	5106	1585
Grp Volume(v), veh/h	780	885	0	226	536	0	546	2828	0	618	3423	0
Grp Sat Flow(s),veh/h/ln	1728	1702	1585	1728	1702	1585	1728	1702	1585	1728	1702	1585
Q Serve(g_s), s	15.0	22.2	0.0	8.5	12.6	0.0	13.0	57.8	0.0	12.0	56.8	0.0
Cycle Q Clear(g_c), s	15.0	22.2	0.0	8.5	12.6	0.0	13.0	57.8	0.0	12.0	56.8	0.0
Prop In Lane	1.00		1.00	1.00		1.00	1.00		1.00	1.00		1.00
Lane Grp Cap(c), veh/h	399	1127		239	891		346	2271		319	2232	
V/C Ratio(X)	1.96	0.79		0.94	0.60		1.58	1.25		1.94	1.53	
Avail Cap(c_a), veh/h	399	1375		239	1139		346	2271		319	2232	
HCM Platoon Ratio	0.33	0.33	0.33	1.00	1.00	1.00	1.00	1.00	1.00	1.00	1.00	1.00
Upstream Filter(I)	1.00	1.00	0.00	1.00	1.00	0.00	1.00	1.00	0.00	1.00	1.00	0.00
Uniform Delay (d), s/veh	62.5	57.2	0.0	60.3	49.5	0.0	58.5	36.1	0.0	59.0	36.6	0.0
Incr Delay (d2), s/veh	439.3	2.5	0.0	43.0	0.7	0.0	274.5	114.3	0.0	433.2	242.6	0.0
Initial Q Delay(d3),s/veh	0.0	0.0	0.0	0.0	0.0	0.0	0.0	0.0	0.0	0.0	0.0	0.0
%ile BackOfQ(95%),veh/ln	49.4	15.7	0.0	8.9	9.3	0.0	30.1	68.2	0.0	38.9	111.9	0.0
Unsig. Movement Delay, s/veh												
LnGrp Delay(d),s/veh	501.9	59.8	0.0	103.3	50.1	0.0	333.0	150.4	0.0	492.2	279.2	0.0
LnGrp LOS	F	E		F	D		F	F		F	F	
Approach Vol, veh/h		1665	A		762	A		3374	A		4041	A
Approach Delay, s/veh		266.9			65.9			179.9			311.7	
Approach LOS		F			E			F			F	
Timer - Assigned Phs	1	2	3	4	5	6	7	8				
Phs Duration (G+Y+Rc), s	17.0	64.3	14.0	34.7	18.0	63.3	20.0	28.7				
Change Period (Y+Rc), s	5.0	6.5	5.0	6.0	5.0	6.5	5.0	6.0				
Max Green Setting (Gmax), s	12.0	51.5	9.0	35.0	13.0	50.5	15.0	29.0				
Max Q Clear Time (g_c+I1), s	14.0	59.8	10.5	24.2	15.0	58.8	17.0	14.6				
Green Ext Time (p_c), s	0.0	0.0	0.0	4.5	0.0	0.0	0.0	3.1				

Intersection Summary

HCM 6th Ctrl Delay	239.9
HCM 6th LOS	F

Notes

Unsignalized Delay for [NBR, EBR, WBR, SBR] is excluded from calculations of the approach delay and intersection delay.

Lanes and Geometrics  
 4: Dransfeldt Rd & Lowe's Access



Lane Group	EBL	EBR	NBL	NBT	SBT	SBR
Lane Configurations						
Ideal Flow (vphp)	1900	1900	1900	1900	1900	1900
Lane Width (ft)	12	12	12	12	12	12
Grade (%)	0%			0%	0%	
Storage Length (ft)	0	0	125			0
Storage Lanes	1	0	1			0
Taper Length (ft)	25		25			
Lane Util. Factor	1.00	1.00	1.00	0.95	1.00	1.00
Ped Bike Factor						
Frt	0.940				0.980	
Flt Protected	0.973		0.950			
Satd. Flow (prot)	1704	0	1770	3539	1825	0
Flt Permitted	0.973		0.950			
Satd. Flow (perm)	1704	0	1770	3539	1825	0
Link Speed (mph)	30			30	30	
Link Distance (ft)	400			232	422	
Travel Time (s)	9.1			5.3	9.6	

Intersection Summary

Area Type: Other

Intersection						
Int Delay, s/veh	1.9					
Movement	EBL	EBR	NBL	NBT	SBT	SBR
Lane Configurations	↔		↔	↑↑	↑	
Traffic Vol, veh/h	61	49	22	884	490	85
Future Vol, veh/h	61	49	22	884	490	85
Conflicting Peds, #/hr	0	0	0	0	0	0
Sign Control	Stop	Stop	Free	Free	Free	Free
RT Channelized	-	None	-	None	-	None
Storage Length	0	-	125	-	-	-
Veh in Median Storage, #	0	-	-	0	0	-
Grade, %	0	-	-	0	0	-
Peak Hour Factor	92	92	92	92	92	92
Heavy Vehicles, %	2	2	2	2	2	2
Mvmt Flow	66	53	24	961	533	92































Major/Minor	Minor2	Major1	Major2			
Conflicting Flow All	1108	579	625	0	-	0
Stage 1	579	-	-	-	-	-
Stage 2	529	-	-	-	-	-
Critical Hdwy	6.63	6.23	4.13	-	-	-
Critical Hdwy Stg 1	5.43	-	-	-	-	-
Critical Hdwy Stg 2	5.83	-	-	-	-	-
Follow-up Hdwy	3.519	3.319	2.219	-	-	-
Pot Cap-1 Maneuver	218	514	954	-	-	-
Stage 1	559	-	-	-	-	-
Stage 2	556	-	-	-	-	-
Platoon blocked, %				-	-	-
Mov Cap-1 Maneuver	213	514	954	-	-	-
Mov Cap-2 Maneuver	213	-	-	-	-	-
Stage 1	545	-	-	-	-	-
Stage 2	556	-	-	-	-	-

Approach	EB	NB	SB
HCM Control Delay, s	26.1	0.2	0
HCM LOS	D		

Minor Lane/Major Mvmt	NBL	NBT	EBLn1	SBT	SBR
Capacity (veh/h)	954	-	288	-	-
HCM Lane V/C Ratio	0.025	-	0.415	-	-
HCM Control Delay (s)	8.9	-	26.1	-	-
HCM Lane LOS	A	-	D	-	-
HCM 95th %tile Q(veh)	0.1	-	1.9	-	-

Lanes and Geometrics  
1: Dransfeldt Rd & Lincoln Ave

Lincoln & Dransfeldt  
09/27/2020

												
Lane Group	EBL	EBT	EBR	WBL	WBT	WBR	NBL	NBT	NBR	SBL	SBT	SBR
Lane Configurations		  			  		 				 	
Ideal Flow (vphpl)	1900	1900	1900	1900	1900	1900	1900	1900	1900	1900	1900	1900
Lane Width (ft)	12	12	12	12	12	12	12	12	12	12	12	12
Grade (%)		0%			0%			0%			0%	
Storage Length (ft)	200		0	330		150	125		0	100		0
Storage Lanes	1		1	1		1	1		1	1		1
Taper Length (ft)	25			25			25			25		
Lane Util. Factor	1.00	0.91	1.00	1.00	0.91	1.00	0.97	1.00	1.00	1.00	1.00	1.00
Ped Bike Factor												
Frt			0.850			0.850			0.850			0.850
Flt Protected	0.950			0.950			0.950			0.950		
Satd. Flow (prot)	1770	5085	1583	1770	5085	1583	3433	1863	1583	1770	1863	1583
Flt Permitted	0.120			0.102			0.594			0.694		
Satd. Flow (perm)	224	5085	1583	190	5085	1583	2147	1863	1583	1293	1863	1583
Right Turn on Red			Yes			Yes			Yes			Yes
Satd. Flow (RTOR)			238			117			265			164
Link Speed (mph)		30			30			30			30	
Link Distance (ft)		584			728			359			293	
Travel Time (s)		13.3			16.5			8.2			6.7	

Intersection Summary

Area Type: Other

Timings  
1: Dransfeldt Rd & Lincoln Ave

Lane Group	EBL	EBT	EBR	WBL	WBT	WBR	NBL	NBT	NBR	SBL	SBT	SBR
Lane Configurations												
Traffic Volume (vph)	51	1098	236	453	1599	6	237	82	244	4	115	64
Future Volume (vph)	51	1098	236	453	1599	6	237	82	244	4	115	64
Turn Type	pm+pt	NA	Perm	pm+pt	NA	Perm	pm+pt	NA	pm+ov	pm+pt	NA	Perm
Protected Phases	7	4		3	8		5	2	3	1	6	
Permitted Phases	4		4	8		8	2		2	6		6
Detector Phase	7	4	4	3	8	8	5	2	3	1	6	6
Switch Phase												
Minimum Initial (s)	3.0	10.0	10.0	4.0	10.0	10.0	5.0	5.0	4.0	5.0	5.0	5.0
Minimum Split (s)	10.0	40.0	40.0	9.5	35.0	35.0	35.0	35.0	9.5	35.0	35.0	35.0
Total Split (s)	17.0	38.0	38.0	32.0	53.0	53.0	32.0	28.0	32.0	32.0	28.0	28.0
Total Split (%)	13.1%	29.2%	29.2%	24.6%	40.8%	40.8%	24.6%	21.5%	24.6%	24.6%	21.5%	21.5%
Yellow Time (s)	4.0	4.0	4.0	3.0	3.0	3.0	3.5	3.5	3.0	3.5	3.5	3.5
All-Red Time (s)	2.0	2.0	2.0	2.0	2.0	2.0	2.0	2.0	2.0	2.0	2.0	2.0
Lost Time Adjust (s)	0.0	0.0	0.0	0.0	0.0	0.0	0.0	0.0	0.0	0.0	0.0	0.0
Total Lost Time (s)	6.0	6.0	6.0	5.0	5.0	5.0	5.5	5.5	5.0	5.5	5.5	5.5
Lead/Lag	Lead	Lag	Lag	Lead	Lag	Lag	Lead	Lag	Lead	Lead	Lag	Lag
Lead-Lag Optimize?	Yes	Yes	Yes	Yes	Yes	Yes	Yes	Yes	Yes	Yes	Yes	Yes
Recall Mode	None	None	None	None	None	None	Max	C-Max	None	Max	Max	Max
Act Effect Green (s)	39.6	32.0	32.0	65.0	53.7	53.7	49.0	22.5	55.0	49.0	22.5	22.5
Actuated g/C Ratio	0.30	0.25	0.25	0.50	0.41	0.41	0.38	0.17	0.42	0.38	0.17	0.17
v/c Ratio	0.35	0.95	0.45	1.16	0.83	0.01	0.24	0.28	0.32	0.01	0.39	0.17
Control Delay	26.7	64.8	9.1	132.3	39.0	0.0	24.5	49.4	3.8	22.2	51.8	0.9
Queue Delay	0.0	0.0	0.0	0.0	0.0	0.0	0.0	0.0	0.0	0.0	0.0	0.0
Total Delay	26.7	64.8	9.1	132.3	39.0	0.0	24.5	49.4	3.8	22.2	51.8	0.9
LOS	C	E	A	F	D	A	C	D	A	C	D	A
Approach Delay		53.9			59.4			19.1			33.3	
Approach LOS		D			E			B			C	

Intersection Summary

Cycle Length: 130  
 Actuated Cycle Length: 130  
 Offset: 0 (0%), Referenced to phase 2:NBTL, Start of Green  
 Natural Cycle: 150  
 Control Type: Actuated-Coordinated  
 Maximum v/c Ratio: 1.16  
 Intersection Signal Delay: 51.0  
 Intersection LOS: D  
 Intersection Capacity Utilization 73.5%  
 ICU Level of Service D  
 Analysis Period (min) 15

Splits and Phases: 1: Dransfeldt Rd & Lincoln Ave

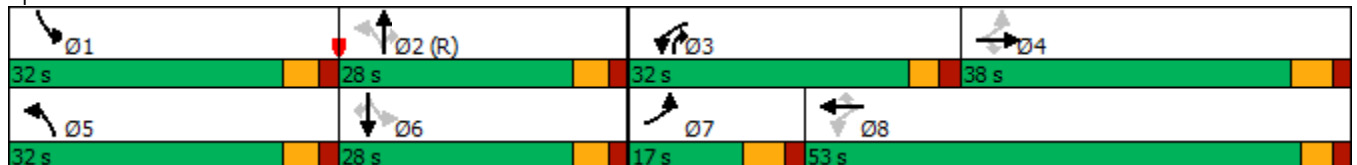

Queues

1: Dransfeldt Rd & Lincoln Ave

09/27/2020

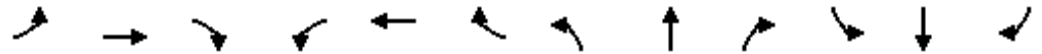

Lane Group	EBL	EBT	EBR	WBL	WBT	WBR	NBL	NBT	NBR	SBL	SBT	SBR
Lane Group Flow (vph)	55	1193	257	492	1738	7	258	89	265	4	125	70
v/c Ratio	0.35	0.95	0.45	1.16	0.83	0.01	0.24	0.28	0.32	0.01	0.39	0.17
Control Delay	26.7	64.8	9.1	132.3	39.0	0.0	24.5	49.4	3.8	22.2	51.8	0.9
Queue Delay	0.0	0.0	0.0	0.0	0.0	0.0	0.0	0.0	0.0	0.0	0.0	0.0
Total Delay	26.7	64.8	9.1	132.3	39.0	0.0	24.5	49.4	3.8	22.2	51.8	0.9
Queue Length 50th (ft)	24	364	12	~443	487	0	69	66	0	2	95	0
Queue Length 95th (ft)	48	#460	85	#663	570	0	98	118	51	9	158	0
Internal Link Dist (ft)		504			648			279			213	
Turn Bay Length (ft)	200			330		150	125			100		
Base Capacity (vph)	204	1251	569	423	2101	722	1071	322	822	584	322	409
Starvation Cap Reductn	0	0	0	0	0	0	0	0	0	0	0	0
Spillback Cap Reductn	0	0	0	0	0	0	0	0	0	0	0	0
Storage Cap Reductn	0	0	0	0	0	0	0	0	0	0	0	0
Reduced v/c Ratio	0.27	0.95	0.45	1.16	0.83	0.01	0.24	0.28	0.32	0.01	0.39	0.17

Intersection Summary

- ~ Volume exceeds capacity, queue is theoretically infinite.  
Queue shown is maximum after two cycles.
- # 95th percentile volume exceeds capacity, queue may be longer.  
Queue shown is maximum after two cycles.

HCM 6th Signalized Intersection Summary  
1: Dransfeldt Rd & Lincoln Ave

Lincoln & Dransfeldt  
09/27/2020

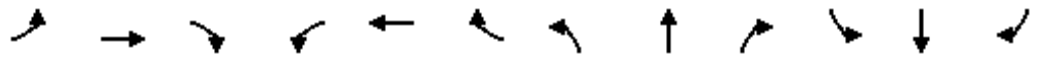

Movement	EBL	EBT	EBR	WBL	WBT	WBR	NBL	NBT	NBR	SBL	SBT	SBR
Lane Configurations	↘	↑↑↑	↗	↘	↑↑↑	↗	↘↗	↑	↗	↘	↑	↗
Traffic Volume (veh/h)	51	1098	236	453	1599	6	237	82	244	4	115	64
Future Volume (veh/h)	51	1098	236	453	1599	6	237	82	244	4	115	64
Initial Q (Qb), veh	0	0	0	0	0	0	0	0	0	0	0	0
Ped-Bike Adj(A_pbT)	1.00		1.00	1.00		1.00	1.00		1.00	1.00		1.00
Parking Bus, Adj	1.00	1.00	1.00	1.00	1.00	1.00	1.00	1.00	1.00	1.00	1.00	1.00
Work Zone On Approach		No			No			No			No	
Adj Sat Flow, veh/h/ln	1870	1870	1870	1870	1870	1870	1870	1870	1870	1870	1870	1870
Adj Flow Rate, veh/h	55	1193	257	492	1738	7	258	89	265	4	125	70
Peak Hour Factor	0.92	0.92	0.92	0.92	0.92	0.92	0.92	0.92	0.92	0.92	0.92	0.92
Percent Heavy Veh, %	2	2	2	2	2	2	2	2	2	2	2	2
Cap, veh/h	145	1256	390	431	2107	654	1078	324	604	554	324	275
Arrive On Green	0.03	0.25	0.25	0.21	0.41	0.41	0.20	0.17	0.17	0.20	0.17	0.17
Sat Flow, veh/h	1781	5106	1585	1781	5106	1585	3456	1870	1585	1781	1870	1585
Grp Volume(v), veh/h	55	1193	257	492	1738	7	258	89	265	4	125	70
Grp Sat Flow(s),veh/h/ln	1781	1702	1585	1781	1702	1585	1728	1870	1585	1781	1870	1585
Q Serve(g_s), s	3.0	29.9	19.0	27.0	39.4	0.3	6.5	5.4	16.2	0.2	7.7	5.0
Cycle Q Clear(g_c), s	3.0	29.9	19.0	27.0	39.4	0.3	6.5	5.4	16.2	0.2	7.7	5.0
Prop In Lane	1.00		1.00	1.00		1.00	1.00		1.00	1.00		1.00
Lane Grp Cap(c), veh/h	145	1256	390	431	2107	654	1078	324	604	554	324	275
V/C Ratio(X)	0.38	0.95	0.66	1.14	0.82	0.01	0.24	0.27	0.44	0.01	0.39	0.25
Avail Cap(c_a), veh/h	236	1257	390	431	2107	654	1078	324	604	554	324	275
HCM Platoon Ratio	1.00	1.00	1.00	1.00	1.00	1.00	1.00	1.00	1.00	1.00	1.00	1.00
Upstream Filter(I)	1.00	1.00	1.00	1.00	1.00	1.00	1.00	1.00	1.00	1.00	1.00	1.00
Uniform Delay (d), s/veh	36.3	48.2	44.1	39.8	34.0	22.5	27.5	46.6	29.9	25.4	47.6	46.5
Incr Delay (d2), s/veh	1.6	15.0	4.0	87.8	2.8	0.0	0.5	2.1	2.3	0.0	3.4	2.2
Initial Q Delay(d3),s/veh	0.0	0.0	0.0	0.0	0.0	0.0	0.0	0.0	0.0	0.0	0.0	0.0
%ile BackOfQ(95%),veh/ln	2.5	20.6	12.5	35.0	23.3	0.2	5.0	4.9	10.8	0.1	7.1	3.9
Unsig. Movement Delay, s/veh												
LnGrp Delay(d),s/veh	38.0	63.2	48.2	127.5	36.8	22.5	28.0	48.7	32.2	25.4	51.1	48.7
LnGrp LOS	D	E	D	F	D	C	C	D	C	C	D	D
Approach Vol, veh/h		1505			2237			612			199	
Approach Delay, s/veh		59.7			56.7			32.9			49.7	
Approach LOS		E			E			C			D	
Timer - Assigned Phs	1	2	3	4	5	6	7	8				
Phs Duration (G+Y+Rc), s	32.0	28.0	32.0	38.0	32.0	28.0	10.3	59.6				
Change Period (Y+Rc), s	5.5	5.5	5.0	6.0	5.5	5.5	6.0	* 6				
Max Green Setting (Gmax), s	26.5	22.5	27.0	32.0	26.5	22.5	11.0	* 48				
Max Q Clear Time (g_c+I1), s	2.2	18.2	29.0	31.9	8.5	9.7	5.0	41.4				
Green Ext Time (p_c), s	0.0	0.6	0.0	0.1	0.8	0.7	0.0	5.3				

Intersection Summary

HCM 6th Ctrl Delay	54.2
HCM 6th LOS	D

Notes

User approved pedestrian interval to be less than phase max green.  
\* HCM 6th computational engine requires equal clearance times for the phases crossing the barrier.

Lanes and Geometrics  
2: Walgreens Access & Lincoln Ave

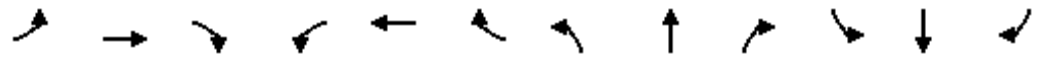

Lane Group	EBL	EBT	EBR	WBL	WBT	WBR	NBL	NBT	NBR	SBL	SBT	SBR
Lane Configurations		↑↑↑			↑↑↑				↑			↑
Ideal Flow (vphpl)	1900	1900	1900	1900	1900	1900	1900	1900	1900	1900	1900	1900
Lane Width (ft)	12	12	12	12	12	12	12	12	12	12	12	12
Grade (%)		0%			0%			0%			0%	
Storage Length (ft)	0		0	0		0	0		0	0		0
Storage Lanes	0		0	0		0	0		1	0		1
Taper Length (ft)	25			25			25			25		
Lane Util. Factor	1.00	0.91	0.91	1.00	0.91	0.91	1.00	1.00	1.00	1.00	1.00	1.00
Ped Bike Factor		0.992			0.996				0.865			0.865
Flt Protected												
Satd. Flow (prot)	0	5045	0	0	5065	0	0	0	1611	0	0	1611
Flt Permitted												
Satd. Flow (perm)	0	5045	0	0	5065	0	0	0	1611	0	0	1611
Link Speed (mph)		30			30			30				30
Link Distance (ft)		552			564			202				173
Travel Time (s)		12.5			12.8			4.6				3.9

Intersection Summary

Area Type: Other

Intersection												
Int Delay, s/veh	3.1											
Movement	EBL	EBT	EBR	WBL	WBT	WBR	NBL	NBT	NBR	SBL	SBT	SBR
Lane Configurations	↑↑↑			↑↑↑					↑			↑
Traffic Vol, veh/h	0	1274	73	0	2010	49	0	0	217	0	0	48
Future Vol, veh/h	0	1274	73	0	2010	49	0	0	217	0	0	48
Conflicting Peds, #/hr	0	0	0	0	0	0	0	0	0	0	0	0
Sign Control	Free	Free	Free	Free	Free	Free	Stop	Stop	Stop	Stop	Stop	Stop
RT Channelized	-	-	None	-	-	None	-	-	None	-	-	None
Storage Length	-	-	-	-	-	-	-	-	0	-	-	0
Veh in Median Storage, #	-	0	-	-	0	-	-	0	-	-	0	-
Grade, %	-	0	-	-	0	-	-	0	-	-	0	-
Peak Hour Factor	92	92	92	92	92	92	92	92	92	92	92	92
Heavy Vehicles, %	2	2	2	2	2	2	2	2	2	2	2	2
Mvmt Flow	0	1385	79	0	2185	53	0	0	236	0	0	52

Major/Minor	Major1		Major2		Minor1		Minor2					
Conflicting Flow All	-	0	0	-	-	0	-	-	732	-	-	1119
Stage 1	-	-	-	-	-	-	-	-	-	-	-	-
Stage 2	-	-	-	-	-	-	-	-	-	-	-	-
Critical Hdwy	-	-	-	-	-	-	-	-	7.14	-	-	7.14
Critical Hdwy Stg 1	-	-	-	-	-	-	-	-	-	-	-	-
Critical Hdwy Stg 2	-	-	-	-	-	-	-	-	-	-	-	-
Follow-up Hdwy	-	-	-	-	-	-	-	-	3.92	-	-	3.92
Pot Cap-1 Maneuver	0	-	-	0	-	-	0	0	312	0	0	173
Stage 1	0	-	-	0	-	-	0	0	-	0	0	-
Stage 2	0	-	-	0	-	-	0	0	-	0	0	-
Platoon blocked, %	-	-	-	-	-	-	-	-	-	-	-	-
Mov Cap-1 Maneuver	-	-	-	-	-	-	-	-	312	-	-	173
Mov Cap-2 Maneuver	-	-	-	-	-	-	-	-	-	-	-	-
Stage 1	-	-	-	-	-	-	-	-	-	-	-	-
Stage 2	-	-	-	-	-	-	-	-	-	-	-	-

Approach	EB	WB	NB	SB
HCM Control Delay, s	0	0	44.9	34.6
HCM LOS			E	D

Minor Lane/Major Mvmt	NBLn1	EBT	EBR	WBT	WBR	SBLn1
Capacity (veh/h)	312	-	-	-	-	173
HCM Lane V/C Ratio	0.756	-	-	-	-	0.302
HCM Control Delay (s)	44.9	-	-	-	-	34.6
HCM Lane LOS	E	-	-	-	-	D
HCM 95th %tile Q(veh)	5.8	-	-	-	-	1.2

Lanes and Geometrics  
3: Parker Rd & Lincoln Ave



Lane Group	EBL	EBT	EBR	WBL	WBT	WBR	NBL	NBT	NBR	SBL	SBT	SBR
Lane Configurations												
Ideal Flow (vphpl)	1900	1900	1900	1900	1900	1900	1900	1900	1900	1900	1900	1900
Lane Width (ft)	12	12	12	12	12	12	12	12	12	12	12	12
Grade (%)		0%			0%			0%			0%	
Storage Length (ft)	275		150	200		0	500		0	400		0
Storage Lanes	2		1	2		1	2		1	2		1
Taper Length (ft)	25			25			25			25		
Lane Util. Factor	0.97	0.91	1.00	0.97	0.91	1.00	0.97	0.91	1.00	0.97	0.91	1.00
Ped Bike Factor			0.850			0.850			0.850			0.850
Flt Protected	0.950			0.950			0.950			0.950		
Satd. Flow (prot)	3433	5085	1583	3433	5085	1583	3433	5085	1583	3433	5085	1583
Flt Permitted	0.950			0.950			0.950			0.950		
Satd. Flow (perm)	3433	5085	1583	3433	5085	1583	3433	5085	1583	3433	5085	1583
Right Turn on Red			Yes			Yes			Yes			Yes
Satd. Flow (RTOR)			228			462			109			210
Link Speed (mph)		30			30			30			30	
Link Distance (ft)		564			615			787			768	
Travel Time (s)		12.8			14.0			17.9			17.5	

Intersection Summary

Area Type: Other

Timings  
3: Parker Rd & Lincoln Ave

Lane Group	EBL	EBT	EBR	WBL	WBT	WBR	NBL	NBT	NBR	SBL	SBT	SBR
Lane Configurations												
Traffic Volume (vph)	435	631	400	224	971	560	618	2222	132	309	1862	469
Future Volume (vph)	435	631	400	224	971	560	618	2222	132	309	1862	469
Turn Type	Prot	NA	Perm	Prot	NA	Free	Prot	NA	Perm	Prot	NA	Free
Protected Phases	7	4		3	8		5	2		1	6	
Permitted Phases			4			Free			2			Free
Detector Phase	7	4	4	3	8		5	2	2	1	6	
Switch Phase												
Minimum Initial (s)	5.0	5.0	5.0	5.0	5.0		5.0	5.0	5.0	5.0	5.0	
Minimum Split (s)	10.0	35.0	35.0	10.0	35.0		15.0	30.5	30.5	10.0	30.5	
Total Split (s)	18.0	40.0	40.0	17.0	39.0		24.0	58.0	58.0	15.0	49.0	
Total Split (%)	13.8%	30.8%	30.8%	13.1%	30.0%		18.5%	44.6%	44.6%	11.5%	37.7%	
Yellow Time (s)	3.0	4.0	4.0	3.0	4.0		3.0	4.5	4.5	3.0	4.5	
All-Red Time (s)	2.0	2.0	2.0	2.0	2.0		2.0	2.0	2.0	2.0	2.0	
Lost Time Adjust (s)	0.0	0.0	0.0	0.0	0.0		0.0	0.0	0.0	0.0	0.0	
Total Lost Time (s)	5.0	6.0	6.0	5.0	6.0		5.0	6.5	6.5	5.0	6.5	
Lead/Lag	Lead	Lag	Lag	Lead	Lag		Lead	Lag	Lag	Lead	Lag	
Lead-Lag Optimize?	Yes	Yes	Yes	Yes	Yes		Yes	Yes	Yes	Yes	Yes	
Recall Mode	None	None	None	None	None		None	C-Max	C-Max	None	C-Max	
Act Effect Green (s)	13.0	33.4	33.4	11.8	32.2	130.0	19.8	51.5	51.5	10.8	42.5	130.0
Actuated g/C Ratio	0.10	0.26	0.26	0.09	0.25	1.00	0.15	0.40	0.40	0.08	0.33	1.00
v/c Ratio	1.38	0.53	0.76	0.78	0.84	0.38	1.28	1.20	0.21	1.17	1.22	0.32
Control Delay	226.0	57.0	38.7	75.7	53.4	0.7	185.4	130.3	8.3	159.7	142.0	0.5
Queue Delay	0.0	0.0	0.0	0.0	0.0	0.0	0.0	0.0	0.0	0.0	0.0	0.0
Total Delay	226.0	57.0	38.7	75.7	53.4	0.7	185.4	130.3	8.3	159.7	142.0	0.5
LOS	F	E	D	E	D	A	F	F	A	F	F	A
Approach Delay		102.2			39.4			136.3			118.9	
Approach LOS		F			D			F			F	

Intersection Summary

Cycle Length: 130  
 Actuated Cycle Length: 130  
 Offset: 0 (0%), Referenced to phase 2:NBT and 6:SBT, Start of Green  
 Natural Cycle: 145  
 Control Type: Actuated-Coordinated  
 Maximum v/c Ratio: 1.38  
 Intersection Signal Delay: 106.2  
 Intersection LOS: F  
 Intersection Capacity Utilization 103.5%  
 ICU Level of Service G  
 Analysis Period (min) 15

Splits and Phases: 3: Parker Rd & Lincoln Ave

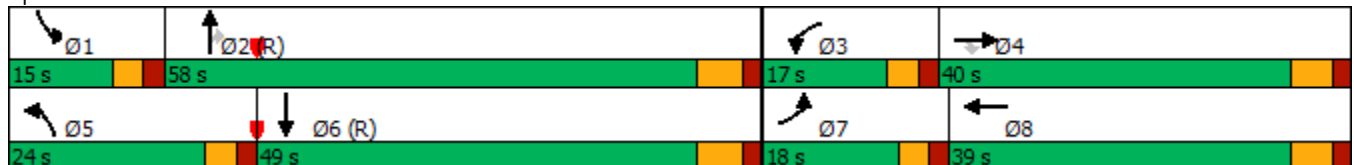

Queues  
3: Parker Rd & Lincoln Ave



Lane Group	EBL	EBT	EBR	WBL	WBT	WBR	NBL	NBT	NBR	SBL	SBT	SBR
Lane Group Flow (vph)	473	686	435	243	1055	609	672	2415	143	336	2024	510
v/c Ratio	1.38	0.53	0.76	0.78	0.84	0.38	1.28	1.20	0.21	1.17	1.22	0.32
Control Delay	226.0	57.0	38.7	75.7	53.4	0.7	185.4	130.3	8.3	159.7	142.0	0.5
Queue Delay	0.0	0.0	0.0	0.0	0.0	0.0	0.0	0.0	0.0	0.0	0.0	0.0
Total Delay	226.0	57.0	38.7	75.7	53.4	0.7	185.4	130.3	8.3	159.7	142.0	0.5
Queue Length 50th (ft)	~278	160	179	104	308	0	~379	~902	18	~184	~764	0
Queue Length 95th (ft)	m#238	m143	m155	#163	364	0	#501	#993	61	#283	#859	0
Internal Link Dist (ft)		484			535			707			688	
Turn Bay Length (ft)	275		150	200			500			400		
Base Capacity (vph)	343	1329	582	316	1290	1583	523	2014	692	286	1662	1583
Starvation Cap Reductn	0	0	0	0	0	0	0	0	0	0	0	0
Spillback Cap Reductn	0	0	0	0	0	0	0	0	0	0	0	0
Storage Cap Reductn	0	0	0	0	0	0	0	0	0	0	0	0
Reduced v/c Ratio	1.38	0.52	0.75	0.77	0.82	0.38	1.28	1.20	0.21	1.17	1.22	0.32

Intersection Summary

- ~ Volume exceeds capacity, queue is theoretically infinite.  
Queue shown is maximum after two cycles.
- # 95th percentile volume exceeds capacity, queue may be longer.  
Queue shown is maximum after two cycles.
- m Volume for 95th percentile queue is metered by upstream signal.

HCM 6th Signalized Intersection Summary  
3: Parker Rd & Lincoln Ave

Lincoln & Dransfeldt  
09/27/2020

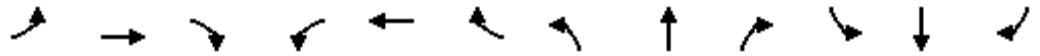

Movement	EBL	EBT	EBR	WBL	WBT	WBR	NBL	NBT	NBR	SBL	SBT	SBR
Lane Configurations	↖↗	↑↑↑	↖	↖↗	↑↑↑	↖	↖↗	↑↑↑	↖	↖↗	↑↑↑	↖
Traffic Volume (veh/h)	435	631	400	224	971	560	618	2222	132	309	1862	469
Future Volume (veh/h)	435	631	400	224	971	560	618	2222	132	309	1862	469
Initial Q (Qb), veh	0	0	0	0	0	0	0	0	0	0	0	0
Ped-Bike Adj(A_pbT)	1.00		1.00	1.00		1.00	1.00		1.00	1.00		1.00
Parking Bus, Adj	1.00	1.00	1.00	1.00	1.00	1.00	1.00	1.00	1.00	1.00	1.00	1.00
Work Zone On Approach		No			No			No			No	
Adj Sat Flow, veh/h/ln	1870	1870	1870	1870	1870	1870	1870	1870	1870	1870	1870	1870
Adj Flow Rate, veh/h	473	686	0	243	1055	0	672	2415	0	336	2024	0
Peak Hour Factor	0.92	0.92	0.92	0.92	0.92	0.92	0.92	0.92	0.92	0.92	0.92	0.92
Percent Heavy Veh, %	2	2	2	2	2	2	2	2	2	2	2	2
Cap, veh/h	346	1288		295	1213		505	2106		266	1753	
Arrive On Green	0.17	0.42	0.00	0.09	0.24	0.00	0.15	0.41	0.00	0.08	0.34	0.00
Sat Flow, veh/h	3456	5106	1585	3456	5106	1585	3456	5106	1585	3456	5106	1585
Grp Volume(v), veh/h	473	686	0	243	1055	0	672	2415	0	336	2024	0
Grp Sat Flow(s),veh/h/ln	1728	1702	1585	1728	1702	1585	1728	1702	1585	1728	1702	1585
Q Serve(g_s), s	13.0	13.0	0.0	9.0	25.8	0.0	19.0	53.6	0.0	10.0	44.6	0.0
Cycle Q Clear(g_c), s	13.0	13.0	0.0	9.0	25.8	0.0	19.0	53.6	0.0	10.0	44.6	0.0
Prop In Lane	1.00		1.00	1.00		1.00	1.00		1.00	1.00		1.00
Lane Grp Cap(c), veh/h	346	1288		295	1213		505	2106		266	1753	
V/C Ratio(X)	1.37	0.53		0.82	0.87		1.33	1.15		1.26	1.15	
Avail Cap(c_a), veh/h	346	1335		319	1296		505	2106		266	1753	
HCM Platoon Ratio	1.67	1.67	1.67	1.00	1.00	1.00	1.00	1.00	1.00	1.00	1.00	1.00
Upstream Filter(I)	1.00	1.00	0.00	1.00	1.00	0.00	1.00	1.00	0.00	1.00	1.00	0.00
Uniform Delay (d), s/veh	54.1	31.9	0.0	58.5	47.6	0.0	55.5	38.2	0.0	60.0	42.7	0.0
Incr Delay (d2), s/veh	183.4	0.4	0.0	15.1	6.3	0.0	161.9	72.1	0.0	145.3	76.6	0.0
Initial Q Delay(d3),s/veh	0.0	0.0	0.0	0.0	0.0	0.0	0.0	0.0	0.0	0.0	0.0	0.0
%ile BackOfQ(95%),veh/ln	22.5	8.4	0.0	8.1	17.2	0.0	30.3	50.4	0.0	16.0	44.0	0.0
Unsig. Movement Delay, s/veh												
LnGrp Delay(d),s/veh	237.6	32.3	0.0	73.6	54.0	0.0	217.4	110.3	0.0	205.3	119.3	0.0
LnGrp LOS	F	C		E	D		F	F		F	F	
Approach Vol, veh/h		1159	A		1298	A		3087	A		2360	A
Approach Delay, s/veh		116.1			57.7			133.6			131.5	
Approach LOS		F			E			F			F	
Timer - Assigned Phs	1	2	3	4	5	6	7	8				
Phs Duration (G+Y+Rc), s	15.0	60.1	16.1	38.8	24.0	51.1	18.0	36.9				
Change Period (Y+Rc), s	5.0	6.5	5.0	6.0	5.0	6.5	5.0	6.0				
Max Green Setting (Gmax), s	10.0	51.5	12.0	34.0	19.0	42.5	13.0	33.0				
Max Q Clear Time (g_c+I1), s	12.0	55.6	11.0	15.0	21.0	46.6	15.0	27.8				
Green Ext Time (p_c), s	0.0	0.0	0.1	4.6	0.0	0.0	0.0	3.1				

Intersection Summary

HCM 6th Ctrl Delay	117.9
HCM 6th LOS	F

Notes

Unsignalized Delay for [NBR, EBR, WBR, SBR] is excluded from calculations of the approach delay and intersection delay.

Lanes and Geometrics  
 4: Dransfeldt Rd & Lowe's Access/West Site Access

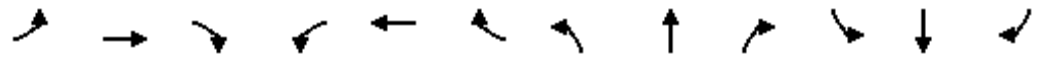

Lane Group	EBL	EBT	EBR	WBL	WBT	WBR	NBL	NBT	NBR	SBL	SBT	SBR
Lane Configurations		↕↔			↕	↗	↖	↕↔		↖	↕↔	
Ideal Flow (vphpl)	1900	1900	1900	1900	1900	1900	1900	1900	1900	1900	1900	1900
Lane Width (ft)	12	12	12	12	12	12	12	12	12	12	12	12
Grade (%)		0%			0%			0%			0%	
Storage Length (ft)	0		0	0		0	150		0	100		0
Storage Lanes	0		0	0		1	1		0	1		0
Taper Length (ft)	25			25			25			25		
Lane Util. Factor	1.00	1.00	1.00	1.00	1.00	1.00	1.00	0.95	0.95	1.00	0.95	0.95
Ped Bike Factor		0.953				0.850		0.987			0.982	
Flt Protected		0.980			0.968		0.950		0.950			
Satd. Flow (prot)	0	1740	0	0	1803	1583	1770	3493	0	1770	3476	0
Flt Permitted		0.980			0.968		0.950		0.950			
Satd. Flow (perm)	0	1740	0	0	1803	1583	1770	3493	0	1770	3476	0
Link Speed (mph)		30			30		30		30		30	
Link Distance (ft)		347			304		217		359			
Travel Time (s)		7.9			6.9		4.9		8.2			

Intersection Summary

Area Type: Other

HCM 6th TWSC  
 4: Dransfeldt Rd & Lowe's Access/West Site Access

Intersection												
Int Delay, s/veh	33											
Movement	EBL	EBT	EBR	WBL	WBT	WBR	NBL	NBT	NBR	SBL	SBT	SBR
Lane Configurations		↕			↕	↕	↕	↕		↕	↕	
Traffic Vol, veh/h	36	20	30	39	20	137	24	406	40	300	442	62
Future Vol, veh/h	36	20	30	39	20	137	24	406	40	300	442	62
Conflicting Peds, #/hr	0	0	0	0	0	0	0	0	0	0	0	0
Sign Control	Stop	Stop	Stop	Stop	Stop	Stop	Free	Free	Free	Free	Free	Free
RT Channelized	-	-	None	-	-	None	-	-	None	-	-	None
Storage Length	-	-	-	-	-	0	150	-	-	100	-	-
Veh in Median Storage, #	-	0	-	-	0	-	-	0	-	-	0	-
Grade, %	-	0	-	-	0	-	-	0	-	-	0	-
Peak Hour Factor	92	92	92	92	92	92	92	92	92	92	92	92
Heavy Vehicles, %	2	2	2	2	2	2	2	2	2	2	2	2
Mvmt Flow	39	22	33	42	22	149	26	441	43	326	480	67

Major/Minor	Minor2		Minor1		Major1		Major2					
Conflicting Flow All	1450	1702	274	1418	1714	242	547	0	0	484	0	0
Stage 1	1166	1166	-	515	515	-	-	-	-	-	-	-
Stage 2	284	536	-	903	1199	-	-	-	-	-	-	-
Critical Hdwy	7.54	6.54	6.94	7.54	6.54	6.94	4.14	-	-	4.14	-	-
Critical Hdwy Stg 1	6.54	5.54	-	6.54	5.54	-	-	-	-	-	-	-
Critical Hdwy Stg 2	6.54	5.54	-	6.54	5.54	-	-	-	-	-	-	-
Follow-up Hdwy	3.52	4.02	3.32	3.52	4.02	3.32	2.22	-	-	2.22	-	-
Pot Cap-1 Maneuver	92	91	724	97	89	759	1018	-	-	1075	-	-
Stage 1	206	266	-	511	533	-	-	-	-	-	-	-
Stage 2	699	522	-	299	257	-	-	-	-	-	-	-
Platoon blocked, %								-	-	-	-	-
Mov Cap-1 Maneuver	41	62	724	52	60	759	1018	-	-	1075	-	-
Mov Cap-2 Maneuver	41	62	-	52	60	-	-	-	-	-	-	-
Stage 1	201	185	-	498	519	-	-	-	-	-	-	-
Stage 2	525	508	-	176	179	-	-	-	-	-	-	-





























Approach	EB	WB	NB	SB
HCM Control Delay, s\$	332.4	100.1	0.4	3.7
HCM LOS	F	F		

Minor Lane/Major Mvmt	NBL	NBT	NBR	EBLn1	WBLn1	WBLn2	SBL	SBT	SBR
Capacity (veh/h)	1018	-	-	69	54	759	1075	-	-
HCM Lane V/C Ratio	0.026	-	-	1.355	1.188	0.196	0.303	-	-
HCM Control Delay (s)	8.6	-	-	\$ 332.4	\$ 307.3	10.9	9.8	-	-
HCM Lane LOS	A	-	-	F	F	B	A	-	-
HCM 95th %tile Q(veh)	0.1	-	-	7.6	5.6	0.7	1.3	-	-

Notes  
 -: Volume exceeds capacity    \$: Delay exceeds 300s    +: Computation Not Defined    \*: All major volume in platoon

Lanes and Geometrics  
1: Dransfeldt Rd & Lincoln Ave

Lincoln & Dransfeldt  
09/27/2020

												
Lane Group	EBL	EBT	EBR	WBL	WBT	WBR	NBL	NBT	NBR	SBL	SBT	SBR
Lane Configurations		  			  		 					
Ideal Flow (vphpl)	1900	1900	1900	1900	1900	1900	1900	1900	1900	1900	1900	1900
Lane Width (ft)	12	12	12	12	12	12	12	12	12	12	12	12
Grade (%)		0%			0%			0%			0%	
Storage Length (ft)	200		0	330		150	125		0	150		0
Storage Lanes	1		1	1		1	1		1	1		1
Taper Length (ft)	25			25			25			25		
Lane Util. Factor	1.00	0.91	1.00	1.00	0.91	1.00	0.97	1.00	1.00	1.00	1.00	1.00
Ped Bike Factor			0.850			0.850			0.850			0.850
Flt Protected	0.950			0.950			0.950			0.950		
Satd. Flow (prot)	1770	5085	1583	1770	5085	1583	3433	1863	1583	1770	1863	1583
Flt Permitted	0.131			0.095			0.587			0.623		
Satd. Flow (perm)	244	5085	1583	177	5085	1583	2121	1863	1583	1160	1863	1583
Right Turn on Red			Yes			Yes			Yes			Yes
Satd. Flow (RTOR)			188			159			513			126
Link Speed (mph)		30			30			30			30	
Link Distance (ft)		568			552			362			354	
Travel Time (s)		12.9			12.5			8.2			8.0	

Intersection Summary

Area Type: Other

Timings  
1: Dransfeldt Rd & Lincoln Ave

Lane Group	EBL	EBT	EBR	WBL	WBT	WBR	NBL	NBT	NBR	SBL	SBT	SBR
Lane Configurations												
Traffic Volume (vph)	116	1536	249	460	1128	27	386	199	472	21	108	116
Future Volume (vph)	116	1536	249	460	1128	27	386	199	472	21	108	116
Turn Type	pm+pt	NA	Perm	pm+pt	NA	Perm	pm+pt	NA	Perm	pm+pt	NA	Perm
Protected Phases	7	4		3	8		5	2		1	6	
Permitted Phases	4		4	8		8	2		2	6		6
Detector Phase	7	4	4	3	8	8	5	2	2	1	6	6
Switch Phase												
Minimum Initial (s)	5.0	5.0	5.0	5.0	5.0	5.0	5.0	5.0	5.0	5.0	5.0	5.0
Minimum Split (s)	10.5	25.5	25.5	10.5	25.5	25.5	10.5	33.5	33.5	33.5	33.5	33.5
Total Split (s)	25.0	42.0	42.0	25.0	42.0	42.0	18.0	34.0	34.0	29.0	45.0	45.0
Total Split (%)	19.2%	32.3%	32.3%	19.2%	32.3%	32.3%	13.8%	26.2%	26.2%	22.3%	34.6%	34.6%
Yellow Time (s)	3.5	3.5	3.5	3.5	3.5	3.5	3.5	3.5	3.5	3.5	3.5	3.5
All-Red Time (s)	2.0	2.0	2.0	2.0	2.0	2.0	2.0	2.0	2.0	2.0	2.0	2.0
Lost Time Adjust (s)	0.0	0.0	0.0	0.0	0.0	0.0	0.0	0.0	0.0	0.0	0.0	0.0
Total Lost Time (s)	5.5	5.5	5.5	5.5	5.5	5.5	5.5	5.5	5.5	5.5	5.5	5.5
Lead/Lag	Lead	Lag	Lag	Lead	Lag	Lag	Lead	Lag	Lag	Lead	Lag	Lag
Lead-Lag Optimize?	Yes	Yes	Yes	Yes	Yes	Yes	Yes	Yes	Yes	Yes	Yes	Yes
Recall Mode	None	None	None	None	None	None	None	C-Max	C-Max	None	C-Max	C-Max
Act Effect Green (s)	47.6	36.5	36.5	61.1	44.9	44.9	57.3	50.0	50.0	46.1	39.6	39.6
Actuated g/C Ratio	0.37	0.28	0.28	0.47	0.35	0.35	0.44	0.38	0.38	0.35	0.30	0.30
v/c Ratio	0.57	1.17	0.47	1.55	0.70	0.04	0.40	0.30	0.56	0.05	0.21	0.22
Control Delay	32.1	126.0	15.0	293.8	39.8	0.1	24.3	30.8	5.1	21.4	34.8	6.5
Queue Delay	0.0	0.0	0.0	0.0	0.0	0.0	0.0	0.0	0.0	0.0	0.0	0.0
Total Delay	32.1	126.0	15.0	293.8	39.8	0.1	24.3	30.8	5.1	21.4	34.8	6.5
LOS	C	F	B	F	D	A	C	C	A	C	C	A
Approach Delay		105.8			111.5			17.0			20.2	
Approach LOS		F			F			B			C	

Intersection Summary

Cycle Length: 130  
 Actuated Cycle Length: 130  
 Offset: 0 (0%), Referenced to phase 2:NBTL and 6:SBTL, Start of Green  
 Natural Cycle: 145  
 Control Type: Actuated-Coordinated  
 Maximum v/c Ratio: 1.55  
 Intersection Signal Delay: 83.9  
 Intersection LOS: F  
 Intersection Capacity Utilization 86.6%  
 ICU Level of Service E  
 Analysis Period (min) 15

Splits and Phases: 1: Dransfeldt Rd & Lincoln Ave

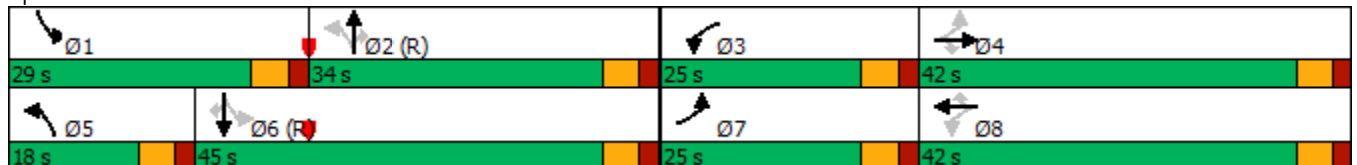

Queues  
1: Dransfeldt Rd & Lincoln Ave

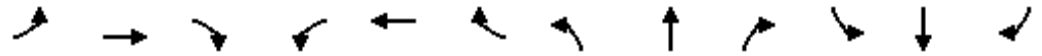

Lane Group	EBL	EBT	EBR	WBL	WBT	WBR	NBL	NBT	NBR	SBL	SBT	SBR
Lane Group Flow (vph)	126	1670	271	500	1226	29	420	216	513	23	117	126
v/c Ratio	0.57	1.17	0.47	1.55	0.70	0.04	0.40	0.30	0.56	0.05	0.21	0.22
Control Delay	32.1	126.0	15.0	293.8	39.8	0.1	24.3	30.8	5.1	21.4	34.8	6.5
Queue Delay	0.0	0.0	0.0	0.0	0.0	0.0	0.0	0.0	0.0	0.0	0.0	0.0
Total Delay	32.1	126.0	15.0	293.8	39.8	0.1	24.3	30.8	5.1	21.4	34.8	6.5
Queue Length 50th (ft)	59	-613	53	-546	323	0	113	133	0	11	73	0
Queue Length 95th (ft)	100	#710	137	#773	402	0	151	205	81	28	124	46
Internal Link Dist (ft)		488			472			282			274	
Turn Bay Length (ft)	200			330		150	125			150		
Base Capacity (vph)	334	1427	579	322	1754	650	1061	716	924	623	568	569
Starvation Cap Reductn	0	0	0	0	0	0	0	0	0	0	0	0
Spillback Cap Reductn	0	0	0	0	0	0	0	0	0	0	0	0
Storage Cap Reductn	0	0	0	0	0	0	0	0	0	0	0	0
Reduced v/c Ratio	0.38	1.17	0.47	1.55	0.70	0.04	0.40	0.30	0.56	0.04	0.21	0.22

Intersection Summary

- ~ Volume exceeds capacity, queue is theoretically infinite.  
Queue shown is maximum after two cycles.
- # 95th percentile volume exceeds capacity, queue may be longer.  
Queue shown is maximum after two cycles.

HCM 6th Signalized Intersection Summary  
1: Dransfeldt Rd & Lincoln Ave

Lincoln & Dransfeldt  
09/27/2020

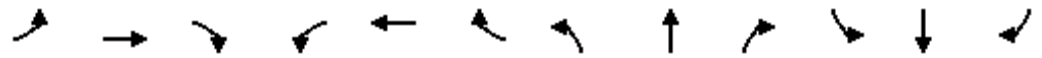

Movement	EBL	EBT	EBR	WBL	WBT	WBR	NBL	NBT	NBR	SBL	SBT	SBR
Lane Configurations												
Traffic Volume (veh/h)	116	1536	249	460	1128	27	386	199	472	21	108	116
Future Volume (veh/h)	116	1536	249	460	1128	27	386	199	472	21	108	116
Initial Q (Qb), veh	0	0	0	0	0	0	0	0	0	0	0	0
Ped-Bike Adj(A_pbT)	1.00		1.00	1.00		1.00	1.00		1.00	1.00		1.00
Parking Bus, Adj	1.00	1.00	1.00	1.00	1.00	1.00	1.00	1.00	1.00	1.00	1.00	1.00
Work Zone On Approach		No			No			No			No	
Adj Sat Flow, veh/h/ln	1870	1870	1870	1870	1870	1870	1870	1870	1870	1870	1870	1870
Adj Flow Rate, veh/h	126	1670	271	500	1226	29	420	216	513	23	117	126
Peak Hour Factor	0.92	0.92	0.92	0.92	0.92	0.92	0.92	0.92	0.92	0.92	0.92	0.92
Percent Heavy Veh, %	2	2	2	2	2	2	2	2	2	2	2	2
Cap, veh/h	246	1434	445	323	1862	578	1011	708	600	310	568	482
Arrive On Green	0.07	0.28	0.28	0.15	0.36	0.36	0.10	0.38	0.38	0.02	0.30	0.30
Sat Flow, veh/h	1781	5106	1585	1781	5106	1585	3456	1870	1585	1781	1870	1585
Grp Volume(v), veh/h	126	1670	271	500	1226	29	420	216	513	23	117	126
Grp Sat Flow(s),veh/h/ln	1781	1702	1585	1781	1702	1585	1728	1870	1585	1781	1870	1585
Q Serve(g_s), s	6.5	36.5	19.3	19.5	26.1	1.5	10.5	10.6	38.7	1.1	6.0	7.8
Cycle Q Clear(g_c), s	6.5	36.5	19.3	19.5	26.1	1.5	10.5	10.6	38.7	1.1	6.0	7.8
Prop In Lane	1.00		1.00	1.00		1.00	1.00		1.00	1.00		1.00
Lane Grp Cap(c), veh/h	246	1434	445	323	1862	578	1011	708	600	310	568	482
V/C Ratio(X)	0.51	1.16	0.61	1.55	0.66	0.05	0.42	0.31	0.86	0.07	0.21	0.26
Avail Cap(c_a), veh/h	395	1434	445	323	1862	578	1011	708	600	593	568	482
HCM Platoon Ratio	1.00	1.00	1.00	1.00	1.00	1.00	1.00	1.00	1.00	1.00	1.00	1.00
Upstream Filter(I)	1.00	1.00	1.00	1.00	1.00	1.00	1.00	1.00	1.00	1.00	1.00	1.00
Uniform Delay (d), s/veh	31.1	46.8	40.6	41.2	34.5	26.7	25.6	28.4	37.1	30.0	33.6	34.2
Incr Delay (d2), s/veh	1.7	82.2	2.4	262.3	0.9	0.0	0.3	1.1	14.5	0.1	0.8	1.3
Initial Q Delay(d3),s/veh	0.0	0.0	0.0	0.0	0.0	0.0	0.0	0.0	0.0	0.0	0.0	0.0
%ile BackOfQ(95%),veh/ln	5.2	37.9	12.4	46.5	16.4	1.1	7.8	8.7	24.1	0.9	5.2	5.8
Unsig. Movement Delay, s/veh												
LnGrp Delay(d),s/veh	32.7	129.0	43.0	303.6	35.4	26.8	25.9	29.5	51.7	30.1	34.4	35.5
LnGrp LOS	C	F	D	F	D	C	C	C	D	C	C	D
Approach Vol, veh/h		2067			1755			1149			266	
Approach Delay, s/veh		111.8			111.6			38.1			34.6	
Approach LOS		F			F			D			C	
Timer - Assigned Phs	1	2	3	4	5	6	7	8				
Phs Duration (G+Y+Rc), s	8.3	54.7	25.0	42.0	18.0	45.0	14.1	52.9				
Change Period (Y+Rc), s	5.5	5.5	5.5	5.5	5.5	5.5	5.5	5.5				
Max Green Setting (Gmax), s	23.5	28.5	19.5	36.5	12.5	39.5	19.5	36.5				
Max Q Clear Time (g_c+I1), s	3.1	40.7	21.5	38.5	12.5	9.8	8.5	28.1				
Green Ext Time (p_c), s	0.0	0.0	0.0	0.0	0.0	1.1	0.2	5.1				

Intersection Summary

HCM 6th Ctrl Delay	91.7
HCM 6th LOS	F

Notes

User approved pedestrian interval to be less than phase max green.

Lanes and Geometrics  
2: Walgreens Access & Lincoln Ave

Lincoln & Dransfeldt

09/27/2020

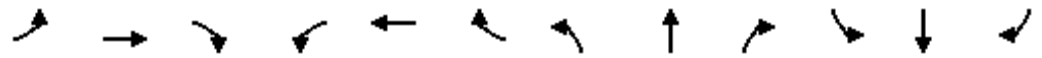

Lane Group	EBL	EBT	EBR	WBL	WBT	WBR	NBL	NBT	NBR	SBL	SBT	SBR
Lane Configurations		↑↑↑			↑↑↑				↑			↑
Ideal Flow (vphpl)	1900	1900	1900	1900	1900	1900	1900	1900	1900	1900	1900	1900
Lane Width (ft)	12	12	12	12	12	12	12	12	12	12	12	12
Grade (%)		0%			0%			0%			0%	
Storage Length (ft)	0		0	0		0	0		0	0		0
Storage Lanes	0		0	0		0	0		1	0		1
Taper Length (ft)	25			25			25			25		
Lane Util. Factor	1.00	0.91	0.91	1.00	0.91	0.91	1.00	1.00	1.00	1.00	1.00	1.00
Ped Bike Factor												
Frt		0.992			0.990				0.865			0.865
Flt Protected												
Satd. Flow (prot)	0	5045	0	0	5034	0	0	0	1611	0	0	1611
Flt Permitted												
Satd. Flow (perm)	0	5045	0	0	5034	0	0	0	1611	0	0	1611
Link Speed (mph)		30			30			30				30
Link Distance (ft)		552			564			131				173
Travel Time (s)		12.5			12.8			3.0				3.9

Intersection Summary

Area Type: Other

Intersection												
Int Delay, s/veh	20.7											
Movement	EBL	EBT	EBR	WBL	WBT	WBR	NBL	NBT	NBR	SBL	SBT	SBR
Lane Configurations	↑↑↑			↑↑↑					↑			↑
Traffic Vol, veh/h	0	1917	111	0	1467	108	0	0	248	0	0	149
Future Vol, veh/h	0	1917	111	0	1467	108	0	0	248	0	0	149
Conflicting Peds, #/hr	0	0	0	0	0	0	0	0	0	0	0	0
Sign Control	Free	Free	Free	Free	Free	Free	Stop	Stop	Stop	Stop	Stop	Stop
RT Channelized	-	-	None	-	-	None	-	-	None	-	-	None
Storage Length	-	-	-	-	-	-	-	-	0	-	-	0
Veh in Median Storage, #	-	0	-	-	0	-	-	0	-	-	0	-
Grade, %	-	0	-	-	0	-	-	0	-	-	0	-
Peak Hour Factor	92	92	92	92	92	92	92	92	92	92	92	92
Heavy Vehicles, %	2	2	2	2	2	2	2	2	2	2	2	2
Mvmt Flow	0	2084	121	0	1595	117	0	0	270	0	0	162

Major/Minor	Major1		Major2		Minor1		Minor2					
Conflicting Flow All	-	0	0	-	-	0	-	-	1103	-	-	856
Stage 1	-	-	-	-	-	-	-	-	-	-	-	-
Stage 2	-	-	-	-	-	-	-	-	-	-	-	-
Critical Hdwy	-	-	-	-	-	-	-	-	7.14	-	-	7.14
Critical Hdwy Stg 1	-	-	-	-	-	-	-	-	-	-	-	-
Critical Hdwy Stg 2	-	-	-	-	-	-	-	-	-	-	-	-
Follow-up Hdwy	-	-	-	-	-	-	-	-	3.92	-	-	3.92
Pot Cap-1 Maneuver	0	-	-	0	-	-	0	0	~ 177	0	0	259
Stage 1	0	-	-	0	-	-	0	0	-	0	0	-
Stage 2	0	-	-	0	-	-	0	0	-	0	0	-
Platoon blocked, %	-	-	-	-	-	-	-	-	-	-	-	-
Mov Cap-1 Maneuver	-	-	-	-	-	-	-	-	~ 177	-	-	259
Mov Cap-2 Maneuver	-	-	-	-	-	-	-	-	-	-	-	-
Stage 1	-	-	-	-	-	-	-	-	-	-	-	-
Stage 2	-	-	-	-	-	-	-	-	-	-	-	-

Approach	EB	WB	NB	SB
HCM Control Delay, s	0	0	\$ 309.7	39.6
HCM LOS			F	E

Minor Lane/Major Mvmt	NBLn1	EBT	EBR	WBT	WBR	SBLn1
Capacity (veh/h)	177	-	-	-	-	259
HCM Lane V/C Ratio	1.523	-	-	-	-	0.625
HCM Control Delay (s)	\$ 309.7	-	-	-	-	39.6
HCM Lane LOS	F	-	-	-	-	E
HCM 95th %tile Q(veh)	17.4	-	-	-	-	3.8

Notes  
 -: Volume exceeds capacity    \$: Delay exceeds 300s    +: Computation Not Defined    \*: All major volume in platoon

Lanes and Geometrics  
3: Parker Rd & Lincoln Ave

Lincoln & Dransfeldt

09/27/2020

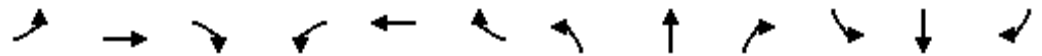

Lane Group	EBL	EBT	EBR	WBL	WBT	WBR	NBL	NBT	NBR	SBL	SBT	SBR
Lane Configurations												
Ideal Flow (vphpl)	1900	1900	1900	1900	1900	1900	1900	1900	1900	1900	1900	1900
Lane Width (ft)	12	12	12	12	12	12	12	12	12	12	12	12
Grade (%)	0%		0%		0%		0%		0%		0%	
Storage Length (ft)	275		150	200		0	500		0	400		0
Storage Lanes	2		1	2		1	2		1	2		1
Taper Length (ft)	25			25			25			25		
Lane Util. Factor	0.97	0.91	1.00	0.97	0.91	1.00	0.97	0.91	1.00	0.97	0.91	1.00
Ped Bike Factor	0.850			0.850			0.850			0.850		
Flt Protected	0.950			0.950			0.950			0.950		
Satd. Flow (prot)	3433	5085	1583	3433	5085	1583	3433	5085	1583	3433	5085	1583
Flt Permitted	0.950			0.950			0.950			0.950		
Satd. Flow (perm)	3433	5085	1583	3433	5085	1583	3433	5085	1583	3433	5085	1583
Right Turn on Red			Yes			Yes			Yes			Yes
Satd. Flow (RTOR)			258			372			151			206
Link Speed (mph)		30			30			30			30	
Link Distance (ft)		564			615			787			768	
Travel Time (s)		12.8			14.0			17.9			17.5	

Intersection Summary

Area Type: Other

Timings  
3: Parker Rd & Lincoln Ave

Lane Group	EBL	EBT	EBR	WBL	WBT	WBR	NBL	NBT	NBR	SBL	SBT	SBR
Lane Configurations												
Traffic Volume (vph)	782	878	486	208	557	342	566	2602	175	569	3149	450
Future Volume (vph)	782	878	486	208	557	342	566	2602	175	569	3149	450
Turn Type	Prot	NA	Perm	Prot	NA	Free	Prot	NA	Perm	Prot	NA	Free
Protected Phases	7	4		3	8		5	2		1	6	
Permitted Phases			4			Free			2			Free
Detector Phase	7	4	4	3	8		5	2	2	1	6	
Switch Phase												
Minimum Initial (s)	5.0	5.0	5.0	5.0	5.0		5.0	5.0	5.0	5.0	5.0	
Minimum Split (s)	10.0	35.0	35.0	10.0	35.0		15.0	30.5	30.5	10.0	30.5	
Total Split (s)	17.0	49.0	49.0	11.0	43.0		20.0	49.0	49.0	21.0	50.0	
Total Split (%)	13.1%	37.7%	37.7%	8.5%	33.1%		15.4%	37.7%	37.7%	16.2%	38.5%	
Yellow Time (s)	3.0	4.0	4.0	3.0	4.0		3.0	4.5	4.5	3.0	4.5	
All-Red Time (s)	2.0	2.0	2.0	2.0	2.0		2.0	2.0	2.0	2.0	2.0	
Lost Time Adjust (s)	0.0	0.0	0.0	0.0	0.0		0.0	0.0	0.0	0.0	0.0	
Total Lost Time (s)	5.0	6.0	6.0	5.0	6.0		5.0	6.5	6.5	5.0	6.5	
Lead/Lag	Lead	Lag	Lag	Lead	Lag		Lead	Lag	Lag	Lead	Lag	
Lead-Lag Optimize?	Yes	Yes	Yes	Yes	Yes		Yes	Yes	Yes	Yes	Yes	
Recall Mode	None	None	None	None	None		None	C-Max	C-Max	None	C-Max	
Act Effct Green (s)	12.0	38.3	38.3	6.0	32.3	130.0	19.7	42.5	42.5	20.7	43.5	130.0
Actuated g/C Ratio	0.09	0.29	0.29	0.05	0.25	1.00	0.15	0.33	0.33	0.16	0.33	1.00
v/c Ratio	2.69	0.64	0.81	1.43	0.48	0.23	1.18	1.70	0.31	1.13	2.01	0.31
Control Delay	786.2	35.8	18.8	268.9	42.4	0.3	148.0	347.9	9.6	129.0	483.3	0.5
Queue Delay	0.0	0.0	0.0	0.0	0.0	0.0	0.0	0.0	0.0	0.0	0.0	0.0
Total Delay	786.2	35.8	18.8	268.9	42.4	0.3	148.0	347.9	9.6	129.0	483.3	0.5
LOS	F	D	B	F	D	A	F	F	A	F	F	A
Approach Delay		305.5			71.9			296.4			382.9	
Approach LOS		F			E			F			F	

Intersection Summary

Cycle Length: 130  
 Actuated Cycle Length: 130  
 Offset: 0 (0%), Referenced to phase 2:NBT and 6:SBT, Start of Green  
 Natural Cycle: 145  
 Control Type: Actuated-Coordinated  
 Maximum v/c Ratio: 2.69  
 Intersection Signal Delay: 308.6  
 Intersection LOS: F  
 Intersection Capacity Utilization 128.8%  
 ICU Level of Service H  
 Analysis Period (min) 15

Splits and Phases: 3: Parker Rd & Lincoln Ave

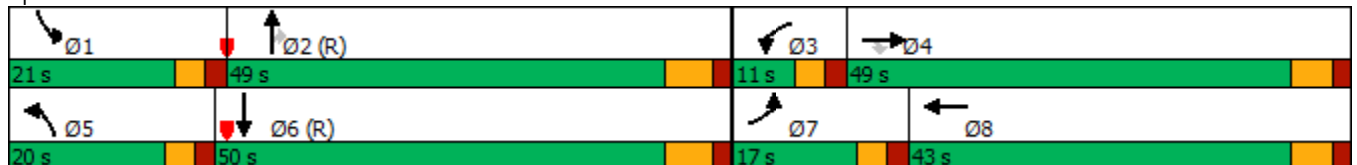

Queues  
3: Parker Rd & Lincoln Ave



Lane Group	EBL	EBT	EBR	WBL	WBT	WBR	NBL	NBT	NBR	SBL	SBT	SBR
Lane Group Flow (vph)	850	954	528	226	605	372	615	2828	190	618	3423	489
v/c Ratio	2.69	0.64	0.81	1.43	0.48	0.23	1.18	1.70	0.31	1.13	2.01	0.31
Control Delay	786.2	35.8	18.8	268.9	42.4	0.3	148.0	347.9	9.6	129.0	483.3	0.5
Queue Delay	0.0	0.0	0.0	0.0	0.0	0.0	0.0	0.0	0.0	0.0	0.0	0.0
Total Delay	786.2	35.8	18.8	268.9	42.4	0.3	148.0	347.9	9.6	129.0	483.3	0.5
Queue Length 50th (ft)	~639	150	103	~132	155	0	~352	~1280	23	~343	~1649	0
Queue Length 95th (ft)	m#490	m112	m66	#217	190	0	#495	#1364	80	#486	#1721	0
Internal Link Dist (ft)		484			535			707			688	
Turn Bay Length (ft)	275		150	200			500			400		
Base Capacity (vph)	316	1681	696	158	1447	1583	519	1662	619	546	1701	1583
Starvation Cap Reductn	0	0	0	0	0	0	0	0	0	0	0	0
Spillback Cap Reductn	0	0	0	0	0	0	0	0	0	0	0	0
Storage Cap Reductn	0	0	0	0	0	0	0	0	0	0	0	0
Reduced v/c Ratio	2.69	0.57	0.76	1.43	0.42	0.23	1.18	1.70	0.31	1.13	2.01	0.31







































Intersection Summary

- ~ Volume exceeds capacity, queue is theoretically infinite.  
Queue shown is maximum after two cycles.
- # 95th percentile volume exceeds capacity, queue may be longer.  
Queue shown is maximum after two cycles.
- m Volume for 95th percentile queue is metered by upstream signal.

HCM 6th Signalized Intersection Summary  
3: Parker Rd & Lincoln Ave

Lincoln & Dransfeldt

09/27/2020

												
Movement	EBL	EBT	EBR	WBL	WBT	WBR	NBL	NBT	NBR	SBL	SBT	SBR
Lane Configurations	 	  		  	  		 	  		  	  	
Traffic Volume (veh/h)	782	878	486	208	557	342	566	2602	175	569	3149	450
Future Volume (veh/h)	782	878	486	208	557	342	566	2602	175	569	3149	450
Initial Q (Qb), veh	0	0	0	0	0	0	0	0	0	0	0	0
Ped-Bike Adj(A_pbT)	1.00		1.00	1.00		1.00	1.00		1.00	1.00		1.00
Parking Bus, Adj	1.00	1.00	1.00	1.00	1.00	1.00	1.00	1.00	1.00	1.00	1.00	1.00
Work Zone On Approach		No			No			No			No	
Adj Sat Flow, veh/h/ln	1870	1870	1870	1870	1870	1870	1870	1870	1870	1870	1870	1870
Adj Flow Rate, veh/h	850	954	0	226	605	0	615	2828	0	618	3423	0
Peak Hour Factor	0.92	0.92	0.92	0.92	0.92	0.92	0.92	0.92	0.92	0.92	0.92	0.92
Percent Heavy Veh, %	2	2	2	2	2	2	2	2	2	2	2	2
Cap, veh/h	319	1190		159	954		399	2168		425	2208	
Arrive On Green	0.15	0.39	0.00	0.05	0.19	0.00	0.12	0.42	0.00	0.12	0.43	0.00
Sat Flow, veh/h	3456	5106	1585	3456	5106	1585	3456	5106	1585	3456	5106	1585
Grp Volume(v), veh/h	850	954	0	226	605	0	615	2828	0	618	3423	0
Grp Sat Flow(s),veh/h/ln	1728	1702	1585	1728	1702	1585	1728	1702	1585	1728	1702	1585
Q Serve(g_s), s	12.0	21.6	0.0	6.0	14.2	0.0	15.0	55.2	0.0	16.0	56.2	0.0
Cycle Q Clear(g_c), s	12.0	21.6	0.0	6.0	14.2	0.0	15.0	55.2	0.0	16.0	56.2	0.0
Prop In Lane	1.00		1.00	1.00		1.00	1.00		1.00	1.00		1.00
Lane Grp Cap(c), veh/h	319	1190		159	954		399	2168		425	2208	
V/C Ratio(X)	2.66	0.80		1.42	0.63		1.54	1.30		1.45	1.55	
Avail Cap(c_a), veh/h	319	1689		159	1453		399	2168		425	2208	
HCM Platoon Ratio	1.67	1.67	1.67	1.00	1.00	1.00	1.00	1.00	1.00	1.00	1.00	1.00
Upstream Filter(I)	1.00	1.00	0.00	1.00	1.00	0.00	1.00	1.00	0.00	1.00	1.00	0.00
Uniform Delay (d), s/veh	55.0	37.0	0.0	62.0	48.8	0.0	57.5	37.4	0.0	57.0	36.9	0.0
Incr Delay (d2), s/veh	758.0	1.9	0.0	220.3	0.7	0.0	256.3	140.4	0.0	216.6	250.0	0.0
Initial Q Delay(d3),s/veh	0.0	0.0	0.0	0.0	0.0	0.0	0.0	0.0	0.0	0.0	0.0	0.0
%ile BackOfQ(95%),veh/ln	60.0	12.9	0.0	13.1	10.2	0.0	32.8	74.1	0.0	31.1	113.3	0.0
Unsig. Movement Delay, s/veh												
LnGrp Delay(d),s/veh	813.0	38.9	0.0	282.3	49.5	0.0	313.8	177.8	0.0	273.6	286.9	0.0
LnGrp LOS	F	D		F	D		F	F		F	F	
Approach Vol, veh/h		1804	A		831	A		3443	A		4041	A
Approach Delay, s/veh		403.7			112.8			202.1			284.9	
Approach LOS		F			F			F			F	
Timer - Assigned Phs	1	2	3	4	5	6	7	8				
Phs Duration (G+Y+Rc), s	21.0	61.7	11.0	36.3	20.0	62.7	17.0	30.3				
Change Period (Y+Rc), s	5.0	6.5	5.0	6.0	5.0	6.5	5.0	6.0				
Max Green Setting (Gmax), s	16.0	42.5	6.0	43.0	15.0	43.5	12.0	37.0				
Max Q Clear Time (g_c+I1), s	18.0	57.2	8.0	23.6	17.0	58.2	14.0	16.2				
Green Ext Time (p_c), s	0.0	0.0	0.0	6.7	0.0	0.0	0.0	4.2				

Intersection Summary

HCM 6th Ctrl Delay	263.7
HCM 6th LOS	F

Notes

Unsignalized Delay for [NBR, EBR, WBR, SBR] is excluded from calculations of the approach delay and intersection delay.

Lanes and Geometrics  
 4: Dransfeldt Rd & Lowe's Site Access/West Site Access

Lincoln & Dransfeldt  
 09/27/2020



Lane Group	EBL	EBT	EBR	WBL	WBT	WBR	NBL	NBT	NBR	SBL	SBT	SBR
Lane Configurations		↕↕			↕	↗	↖	↕↕		↖	↕↕	
Ideal Flow (vphpl)	1900	1900	1900	1900	1900	1900	1900	1900	1900	1900	1900	1900
Lane Width (ft)	12	12	12	12	12	12	12	12	12	12	12	12
Grade (%)		0%			0%			0%			0%	
Storage Length (ft)	0		0	0		0	150		0	100		0
Storage Lanes	0		0	0		1	1		0	1		0
Taper Length (ft)	25			25			25			25		
Lane Util. Factor	1.00	1.00	1.00	1.00	1.00	1.00	1.00	0.95	0.95	1.00	0.95	0.95
Ped Bike Factor												
Frt		0.949				0.850		0.994			0.976	
Flt Protected		0.977			0.968		0.950		0.950			
Satd. Flow (prot)	0	1727	0	0	1803	1583	1770	3518	0	1770	3454	0
Flt Permitted		0.977			0.968		0.950		0.950			
Satd. Flow (perm)	0	1727	0	0	1803	1583	1770	3518	0	1770	3454	0
Link Speed (mph)		30			30			30			30	
Link Distance (ft)		393			324			364			362	
Travel Time (s)		8.9			7.4			8.3			8.2	

Intersection Summary

Area Type: Other

Intersection												
Int Delay, s/veh	277.9											
Movement	EBL	EBT	EBR	WBL	WBT	WBR	NBL	NBT	NBR	SBL	SBT	SBR
Lane Configurations		↕			↕	↕	↕	↕		↕	↕	
Traffic Vol, veh/h	61	19	49	37	18	129	22	879	37	278	454	85
Future Vol, veh/h	61	19	49	37	18	129	22	879	37	278	454	85
Conflicting Peds, #/hr	0	0	0	0	0	0	0	0	0	0	0	0
Sign Control	Stop	Stop	Stop	Stop	Stop	Stop	Free	Free	Free	Free	Free	Free
RT Channelized	-	-	None	-	-	None	-	-	None	-	-	None
Storage Length	-	-	-	-	-	0	150	-	-	100	-	-
Veh in Median Storage, #	-	0	-	-	0	-	-	0	-	-	0	-
Grade, %	-	0	-	-	0	-	-	0	-	-	0	-
Peak Hour Factor	92	92	92	92	92	92	92	92	92	92	92	92
Heavy Vehicles, %	2	2	2	2	2	2	2	2	2	2	2	2
Mvmt Flow	66	21	53	40	20	140	24	955	40	302	493	92

Major/Minor	Minor2		Minor1		Major1			Major2				
Conflicting Flow All	1679	2186	293	1884	2212	498	585	0	0	995	0	0
Stage 1	1143	1143	-	1023	1023	-	-	-	-	-	-	-
Stage 2	536	1043	-	861	1189	-	-	-	-	-	-	-
Critical Hdwy	7.54	6.54	6.94	7.54	6.54	6.94	4.14	-	-	4.14	-	-
Critical Hdwy Stg 1	6.54	5.54	-	6.54	5.54	-	-	-	-	-	-	-
Critical Hdwy Stg 2	6.54	5.54	-	6.54	5.54	-	-	-	-	-	-	-
Follow-up Hdwy	3.52	4.02	3.32	3.52	4.02	3.32	2.22	-	-	2.22	-	-
Pot Cap-1 Maneuver	~ 62	45	703	43	43	518	986	-	-	691	-	-
Stage 1	213	273	-	252	311	-	-	-	-	-	-	-
Stage 2	496	305	-	317	260	-	-	-	-	-	-	-
Platoon blocked, %								-	-	-	-	-
Mov Cap-1 Maneuver	~ 10	25	703	~ 9	24	518	986	-	-	691	-	-
Mov Cap-2 Maneuver	~ 10	25	-	~ 9	24	-	-	-	-	-	-	-
Stage 1	208	154	-	246	304	-	-	-	-	-	-	-
Stage 2	330	298	-	143	146	-	-	-	-	-	-	-

Approach	EB	WB	NB	SB
HCM Control Delay, s \$	3270	\$ 808.4	0.2	4.8
HCM LOS	F	F		

Minor Lane/Major Mvmt	NBL	NBT	NBR	EBLn1	WBLn1	WBLn2	SBL	SBT	SBR
Capacity (veh/h)	986	-	-	19	11	518	691	-	-
HCM Lane V/C Ratio	0.024	-	-	7.38	5.435	0.271	0.437	-	-
HCM Control Delay (s)	8.7	-	-	\$ 3270	2670.3	14.5	14.2	-	-
HCM Lane LOS	A	-	-	F	F	B	B	-	-
HCM 95th %tile Q(veh)	0.1	-	-	18.1	8.7	1.1	2.2	-	-

Notes  
 -: Volume exceeds capacity    \$: Delay exceeds 300s    +: Computation Not Defined    \*: All major volume in platoon